

 	GLOBAL STANDARD	Page 1 of 182
	POWER TRANSFORMERS	<b>GST002</b> Rev. 01 15/01/2014

This document is intellectual property of ENEL Group distribution companies; reproduction or distribution of its contents in any way or by any means whatsoever is subject to the prior approval of the above mentioned companies which will safeguard their rights under the civil and penal codes.

Revision	Date	List of modifications
00	29/11/2013	First emission
01	15/01/2014	General editorial improvements Latam Local Section updated for dimensions and CT prescriptions Italy Local Section updated with option of MV plug-in bushings

Enel Distribuzione			Endesa Distribución Eléctrica		
Emission	Verification	Approval	Emission	Verification	Approval
DIS/IUN/UML	DIS/IUN/UML	DIS/IUN/UML	EDE/PyE	EDE/PyE	EDE/PyE
A. De Simone	F. Mauri	R. Lama	C. Llovich	T. González	F. Giammanco
LATAM			Enel Distributie		
Emission	Verification	Approval	Emission	Verification	Approval
Tecnica Latam	Tecnica Latam	Tecnica Latam	BPCIT	Birou Standardizare	Director Dezvoltare Retea
M. Garcia A. Romero	M. Del Valle W. Sciotto	R. Castañeda	I. Toma	V. Obrejan	A. Pascu

 	GLOBAL STANDARD	Page 2 of 182
	POWER TRANSFORMERS	GST002 Rev. 01 15/01/2014



## INDEX

### COMMON PART

<b>1</b>	<b>SCOPE</b> .....	<b>5</b>
<b>2</b>	<b>LIST OF COMPONENTS</b> .....	<b>6</b>
<b>3</b>	<b>REFERENCE LAWS AND STANDARDS</b> .....	<b>6</b>
<b>3.1</b>	<b>LAWS</b> .....	<b>6</b>
<b>3.2</b>	<b>INTERNATIONAL STANDARDS</b> .....	<b>6</b>
<b>3.3</b>	<b>LOCAL STANDARDS</b> .....	<b>7</b>
<b>3.4</b>	<b>OTHER RELEVANT DOCUMENTS</b> .....	<b>7</b>
<b>3.5</b>	<b>REPLACED STANDARDS</b> .....	<b>7</b>
<b>4</b>	<b>SERVICE CONDITIONS</b> .....	<b>8</b>
<b>5</b>	<b>RATINGS</b> .....	<b>8</b>
<b>5.1</b>	<b>TYPES OF TRANSFORMERS</b> .....	<b>8</b>
<b>5.2</b>	<b>NUMBER OF WINDINGS</b> .....	<b>8</b>
<b>5.3</b>	<b>NUMBER OF PHASES</b> .....	<b>9</b>
<b>5.4</b>	<b>COOLING SYSTEM</b> .....	<b>9</b>
<b>5.5</b>	<b>RATED POWER</b> .....	<b>9</b>
<b>5.6</b>	<b>RATED VOLTAGES</b> .....	<b>9</b>
<b>5.7</b>	<b>RATED FREQUENCY</b> .....	<b>9</b>
<b>5.8</b>	<b>VOLTAGE REGULATION</b> .....	<b>9</b>
5.8.1	HV regulation.....	9
5.8.2	MV regulation.....	9
<b>5.9</b>	<b>WINDINGS CONNECTIONS</b> .....	<b>9</b>
<b>5.10</b>	<b>INSTALLATION</b> .....	<b>9</b>
<b>5.11</b>	<b>HV AND MV NEUTRAL</b> .....	<b>9</b>
<b>5.12</b>	<b>OVER-LOAD CAPABILITY</b> .....	<b>9</b>
<b>5.13</b>	<b>BUSHINGS</b> .....	<b>10</b>
5.13.1	HV Bushings.....	10
5.13.2	MV Bushings.....	10
<b>5.14</b>	<b>INSULATION LEVELS</b> .....	<b>10</b>
<b>5.15</b>	<b>LOSSES AND SHORT CIRCUIT IMPEDANCES</b> .....	<b>11</b>
5.15.1	Losses penalties.....	11
<b>5.16</b>	<b>OVER-EXCITATION CONDITIONS</b> .....	<b>12</b>
<b>5.17</b>	<b>NO-LOAD CURRENT</b> .....	<b>12</b>
<b>5.18</b>	<b>OVER-TEMPERATURE OF THE CORE</b> .....	<b>12</b>
<b>5.19</b>	<b>CAPABILITY TO WITHSTAND SHORT-CIRCUIT</b> .....	<b>12</b>
<b>5.20</b>	<b>SOUND LEVELS</b> .....	<b>12</b>
<b>5.21</b>	<b>OVERALL DIMENSIONS</b> .....	<b>12</b>
<b>5.22</b>	<b>RATING PLATES</b> .....	<b>13</b>
<b>5.23</b>	<b>TOLERANCES</b> .....	<b>13</b>
<b>6</b>	<b>DESIGN REQUIREMENTS</b> .....	<b>13</b>
<b>6.1</b>	<b>CORE AND FRAME</b> .....	<b>13</b>
<b>6.2</b>	<b>WINDINGS</b> .....	<b>13</b>
<b>6.3</b>	<b>HV AND MV NEUTRAL</b> .....	<b>13</b>
<b>6.4</b>	<b>TANK</b> .....	<b>14</b>

 	GLOBAL STANDARD	Page 3 of 182
	POWER TRANSFORMERS	<b>GST002</b> Rev. 01 15/01/2014

<b>6.5</b>	<b>INSULATING LIQUID AND MATERIAL .....</b>	<b>14</b>
<b>6.6</b>	<b>MV WIDINGS CONNECTIONS CHANGE .....</b>	<b>14</b>
<b>6.7</b>	<b>COOLING SYSTEM .....</b>	<b>14</b>
<b>6.8</b>	<b>ACCESSORIES AND AUXILIARIES .....</b>	<b>14</b>
<b>6.9</b>	<b>MARSHALLING BOX.....</b>	<b>15</b>
<b>6.10</b>	<b>PROTECTIVE PAINTING.....</b>	<b>15</b>
<b>7</b>	<b>MAIN COMPONENTS .....</b>	<b>16</b>
<b>7.1</b>	<b>BUSHINGS GENERAL REQUIREMENTS .....</b>	<b>16</b>
7.1.1	HV Bushings .....	16
7.1.1.1	Ratings .....	16
7.1.1.2	Design requirements .....	16
7.1.1.3	Overall dimensions .....	16
7.1.1.4	Tests.....	16
7.1.2	MV Bushings.....	16
7.1.2.1	Ratings .....	16
7.1.2.2	Design Requirements.....	17
7.1.2.3	Overall dimensions.....	17
7.1.2.4	Tests.....	17
<b>7.2</b>	<b>ON LOAD TAP CHANGER.....</b>	<b>17</b>
7.2.1	Ratings.....	17
7.2.2	Design Requirements .....	17
7.2.2.1	Painting.....	17
7.2.2.2	Maintenance .....	17
7.2.2.3	Functional requirements.....	17
7.2.3	Tests .....	17
<b>8</b>	<b>TESTS.....</b>	<b>18</b>
<b>8.1</b>	<b>LIST AND CLASSIFICATION OF TESTS .....</b>	<b>18</b>
8.1.1	Routine tests.....	18
8.1.2	Additional routine tests for transformers with $U_m \geq 72,5$ KV.....	18
8.1.3	Type tests .....	18
8.1.4	Special tests .....	19
8.1.5	General statements for the tests .....	19
8.1.5.1	Short circuit test criteria.....	19
<b>8.2</b>	<b>TEST DESCRIPTION .....</b>	<b>19</b>
8.2.1	Routine tests.....	19
8.2.1.1	Check of the correspondence with the approved prototype.....	19
8.2.1.2	Measurement of winding resistance.....	20
8.2.1.3	Measurement of voltage ratio and check of phase displacement .....	20
8.2.1.4	Measurement of short-circuit impedance and load loss.....	20
8.2.1.5	Measurement of no-load loss and current.....	20
8.2.1.6	Dielectric routine tests .....	20
8.2.1.7	Tests on on-load tap changer, where appropriate .....	20
8.2.1.8	Leak testing with pressure for liquid-immersed transformers (tightness test).....	20
8.2.1.9	Check of the ratio and polarity of built-in current transformers .....	20
8.2.1.10	Check of core and frame insulation for liq. im. transf. with core or frame insulation.....	20
8.2.1.11	Measurement of d.c. ins. res. between each winding to earth and between windings .....	20

 	GLOBAL STANDARD	Page 4 of 182
	POWER TRANSFORMERS	<b>GST002</b> Rev. 01 15/01/2014

8.2.1.12	Check and verification of the components and accessories .....	21
8.2.1.13	Insulating oil tests .....	21
8.2.1.14	Determination of sound level .....	21
8.2.1.15	Check of external coating .....	21
8.2.2	Additional routine tests for transformers with $U_m \geq 72,5$ kV .....	21
8.2.2.1	Determination of capacitances windings-to-earth and between windings .....	21
8.2.2.2	Measurement of dissipation factor ( $\tan \delta$ ) of the insulation system capacitances .....	21
8.2.2.3	Measurement of frequency response (FRA) .....	21
8.2.3	Type tests .....	21
8.2.3.1	Evaluation of the compliance with the specification requirements .....	21
8.2.3.2	Temperature-rise type test .....	21
8.2.3.3	Dielectric type tests .....	22
8.2.3.4	Measurement of the power taken by the fan and liquid pump motors, if any .....	22
8.2.4	Special tests .....	22
8.2.4.1	Dielectric special tests .....	22
8.2.4.2	Determination of transient voltage transfer characteristics .....	22
8.2.4.3	Measurement of zero-sequence impedance(s) on three-phase transformers .....	22
8.2.4.4	Short-circuit withstand test .....	22
8.2.4.5	Vacuum deflection test on liquid immersed transformers .....	22
8.2.4.6	Pressure test on liquid immersed transformers .....	22
<b>9</b>	<b>SUPPLY REQUIREMENTS .....</b>	<b>22</b>
<b>9.1</b>	<b>TRANSPORT .....</b>	<b>22</b>
<b>9.2</b>	<b>COMMISSIONING .....</b>	<b>23</b>
<b>9.3</b>	<b>DOCUMENTATION .....</b>	<b>23</b>
9.3.1	Documentation for the offer .....	23
9.3.2	Documentation for homologation, certification and approval .....	23
9.3.2.1	Not-reserved documentation (Type A) .....	23
9.3.2.2	Reserved documentation (Type B) .....	24
<b>9.4</b>	<b>GUARANTY .....</b>	<b>24</b>
<b>10</b>	<b>EXCEPTIONS .....</b>	<b>24</b>
<b>11</b>	<b>FIGURES .....</b>	<b>25</b>

## ANNEXES

<b>A)</b>	<b>COMMON LIST .....</b>	<b>26</b>
<b>B)</b>	<b>DATA SHEETS FORM OF TRANSFORMER REQUIREMENTS .....</b>	<b>34</b>
<b>C)</b>	<b>TECHNICAL FORM FOR OFFER AND DATA VALIDATION .....</b>	<b>36</b>
<b>D)</b>	<b>LOSSES PRESCRIPTIONS FOR THE EUROPEAN COUNTRIES .....</b>	<b>44</b>

## LOCAL SECTIONS

▪	<b>LATAM .....</b>	<b>47</b>
▪	<b>ENDESA DISTRIBUCIÓN ELECTRICA (SPAIN) .....</b>	<b>75</b>
▪	<b>ENEL DISTRIBUTIE (ROMANIA) .....</b>	<b>106</b>
▪	<b>ENEL DISTRIBUZIONE (ITALY) .....</b>	<b>143</b>

 	GLOBAL STANDARD	Page 5 of 182
	POWER TRANSFORMERS	<b>GST002</b> Rev. 01 15/01/2014

## 1 SCOPE

The scope of this document is to provide technical requirements for the supply of the power transformers to be used in the distribution networks of the Enel Group Distribution Companies, listed below:

- Ampla   Brazil
- Chilectra   Chile
- Codensa   Colombia
- Coelce   Brazil
- Edelnor   Perù
- Edesur   Argentina
- Endesa Distribución Eléctrica           Spain
- Enel Distribuție Banat                       Romania
- Enel Distribuție Dobrogea                Romania
- Enel Distribuție Muntenia                 Romania
- Enel Distribuzione                            Italy

In the document the term "Latam" refers to the Enel Group Distribution Companies in South America.

This document is structured in:

- The "Common Part" with the common requirements for all the Enel Group Distribution Companies.
- The "Common List" with the Type Code for each transformer of the Enel Group Distribution Companies (Annex A).
- The "Data Sheet" form for the main ratings and requirements of each transformer type. Data sheets for the transformers required are attached to the Local Sections for Spain and Latam countries (Annex B) <sup>(1)</sup>.
  - <sup>(1)</sup> Data sheets for Italy and Romania are not used because not necessary for all the main typical transformers, being all requirements specified in their Local Sections. For such countries data sheets can be used for each transformer typology only for specific not common transformers.
- The "Technical Form" with the main data to be submitted in the offer and validated during homologation, certification or approval process (Annex C).
- The annex that explains the losses prescription for the European countries (Annex D).
- The "Local Sections" with the specific requirements of each Enel Group Distribution Company (Latam, Spain, Romania and Italy).

Additional prescriptions or integrations to the Common Part are reported in the Local Sections with the same corresponding clause or sub-clause numbers.

	<b>GLOBAL STANDARD</b>	Page 6 of 182
	<b>POWER TRANSFORMERS</b>	<b>GST002</b> Rev. 01 15/01/2014

## 2 LIST OF COMPONENTS

The list of components with the transformers type codifications is reported in the Common List attached.

## 3 REFERENCE LAWS AND STANDARDS

The lists of reference laws and standards, relevant for this document, are reported here below.

### 3.1 LAWS

See Local Sections.

For the European countries, the performance efficiency of the transformers shall comply with the related European Commission Regulation xxx on Implementing Directive 2009/125/C regarding small, medium and large power transformers (it will be in force from July 2015).

### 3.2 INTERNATIONAL STANDARDS

For Latin America destinations the reference standard are the IEC/ISO and for Europe destinations the reference standard are the correspondent European standards (EN).

IEC 60076-1 (2011)	Power transformers – Part 1: General
IEC 60076-2 (2011)	Power transformers – Part 2: Temperature rise for liquid-immersed transformers
IEC 60076-3 (2013)	Power transformers – Part 3: Insulation levels, dielectric tests and external clearances in air
IEC 60076-5 (2006)	Power transformers – Part 5: Ability to withstand short circuit
IEC 60076-7 (2005)	Power transformers – Part 7: Loading guide for oil-immersed power transformers
IEC 60076-10 (2001)	Determination of sound levels
IEC 60076-18 (2012)	Power transformers – Part 18: Measurement of frequency response
IEC 60137	Insulated bushings for alternating voltages above 1 000 V
IEC 60296	Fluids for electrotechnical applications – Unused mineral insulating oils for transformers and switchgear
IEC 60422	Mineral insulating oils in electrical equipment – Supervision and maintenance guidance
IEC 60599	Mineral oil impregnated in electrical equipment in service – Guide to the interpretation of dissolved and free gases analysis
IEC 60815	Guide for selection and dimensioning of high-voltage insulators for polluted conditions
IEC 60214-1	Tap-Changers – Part 1: Performance requirements and test methods
IEC 60214-2	Tap-Changers – Part 2: Application guide

	GLOBAL STANDARD	Page 7 of 182
	POWER TRANSFORMERS	<b>GST002</b> Rev. 01 15/01/2014

IEC 61462	Composite hollow insulators – Pressurized and unpressurized insulators for use in electrical equipment with rated voltage greater than 1000 V – Definitions, test methods, acceptance criteria and design recommendations
IEC 62155	Hollow pressurized and unpressurized ceramic and glass insulators for use in electrical equipment with rated voltage greater than 1000 V
IEC 62271-209	High-voltage switchgear and controlgear – Part 209: Cable connections for gas-insulated metal-enclosed switchgear for rated voltages above 52 kV and above.
IEC 60529	Degree of protections provided by enclosures (IP Code)
IEC 60947-7-2	Low-voltage switchgear and controlgear – Part 7-2: Ancillary equipment – Protective conductor terminal blocks for copper conductors
ISO 2178	Non-magnetic coatings on magnetic substrates – Measurement of coating thickness –Magnetic method
ISO 2808	Paints and varnishes – Determination of film thickness
ISO 2409	Paints and varnishes – Cross-cut test
ISO 4628-3	Paints and varnishes – Assessment of degree of rusting

And all the Standards referred in those listed above.

When the date of issue is not mentioned in the list above, the date to be taken as reference is that of the standard in force when the present document has been issued.

### 3.3 LOCAL STANDARDS



See Local Sections.

### 3.4 OTHER RELEVANT DOCUMENTS

See Local Sections.

### 3.5 REPLACED STANDARDS

See Local Sections.

 	<b>GLOBAL STANDARD</b>	Page 8 of 182
	<b>POWER TRANSFORMERS</b>	<b>GST002</b> Rev. 01 15/01/2014

#### 4 SERVICE CONDITIONS

Transformers are generally used for step-down voltage purpose but they can also be used as step-up. In the network, they could occasionally be subjected to frequent energizations, over voltages and short-circuits.

Unless otherwise specified the normal service conditions of IEC 60076-1 apply with the following exceptions:

Characteristic	Ampla	Chilectra	Codensa	Coelce	Edelnor	Edesur	Endesa	Enel Distributie	Enel Distribuzione
Altitude (m)			2600						
Pollution level SPS Class (IEC/TS 60815 series)	D – heavy	C – medium	C – medium	E – very heavy	E – very heavy	C – medium	D – heavy or E – very heavy	D – heavy	D – heavy
RUSCD (mm/kV)	43,3	34,7	34,7	53,7	53,7	34,7	43,3 or 53,7	43,3	43,3
Minimum ambient air temperature (°C)								-30 <sup>(1)</sup>	
Maximum ambient air temperature (°C)							40 or 50		
Seismic qualification level		Yes <sup>(2)</sup>	Yes <sup>(2)</sup>		Yes <sup>(2)</sup>			Yes <sup>(2)</sup>	Yes <sup>(2)</sup>

<sup>(1)</sup> For the thermal design the transformer shall be manufactured with reference to the normal ambient temperature values defined in the standard

<sup>(2)</sup> The seismic qualification levels are given in Local Section

#### 5 RATINGS

For the definitions IEC 60076-1 applies.

##### 5.1 TYPES OF TRANSFORMERS

This document is applicable for liquid immersed transformers or auto-transformers, three-phase, bi-phase and single-phase, step-up or step-down and refers to the following types of transformers:

- Separate windings Transformer (TR).
- Auto-Transformer (ATR).

Separate windings Transformers are usually HV/MV, but they can also be HV/HV or MV/MV, in such cases they are conventionally indicated as HV/MV in the present standard.

For further details see Local Sections and Data Sheets.

##### 5.2 NUMBER OF WINDINGS

See Local Sections/Data Sheets.



	GLOBAL STANDARD	Page 9 of 182
	POWER TRANSFORMERS	<b>GST002</b> Rev. 01 15/01/2014

### 5.3 NUMBER OF PHASES

See Local Sections/Data Sheets.

### 5.4 COOLING SYSTEM

See Local Sections/Data Sheets.

### 5.5 RATED POWER

See Local Sections/Data Sheets.

### 5.6 RATED VOLTAGES

See Local Sections/Data Sheets.

### 5.7 RATED FREQUENCY

See Local Sections/Data Sheets.

### 5.8 VOLTAGE REGULATION

#### 5.8.1 HV regulation

When specified, the HV windings shall be provided with voltage regulation according to the values specified.

#### 5.8.2 MV regulation

See Local Sections/Data Sheets.

### 5.9 WINDINGS CONNECTIONS

For the connection symbol see Local Sections/Data Sheets.

When requested, the parameters for double voltage connection (i.e. 20,8-10,4 kV) or delta/star connection are indicated in Local Section/Data Sheets.

### 5.10 INSTALLATION

The type of installation can be indoor or outdoor.

### 5.11 HV AND MV NEUTRAL

See Local Sections/Data Sheets.

	GLOBAL STANDARD	Page 10 of 182
	POWER TRANSFORMERS	<b>GST002</b> Rev. 01 15/01/2014

## 5.12 OVER-LOAD CAPABILITY

According to IEC 60076-7.

No limitation of the transformer power supply shall come from the capability of the bushings, the on-load tap changer and all the other accessories and auxiliary equipment.

The hot-spot temperature of the windings shall be calculated by a proper method in accordance to IEC 60076-2.

## 5.13 BUSHINGS

The bushings shall be compliant with IEC 60137.

All the bushings shall be marked with unalterable name plates, fixed on the tank cover at the base of the bushing, visible from both the HV and MV side, reporting the symbols indicated in the Local Sections.

### 5.13.1 HV Bushings

With regard to the type of connection with the HV feeders, three different types are defined:

- Oil/Air (O/A) bushings.
- Oil/SF<sub>6</sub> (O/S) bushings.
- Oil/Oil (O/O) bushings.

The type of HV bushings, for each transformer type, is indicated in the Local Section.

All the bushings shall have the conductor insulated with oil-impregnated paper and shall be of the capacitor type.

For the other characteristics see Local Sections.

### 5.13.2 MV Bushings

MV bushings shall be of the following types:

- Polymeric type Oil/Air (O/A) bushings.
- Porcelain type Oil/Air (O/A) bushings.
- Plug-in type (Plug-in) bushings.

The type of MV bushings, for each transformer type, is indicated in the Local Section.

## 5.14 INSULATION LEVELS

See Local Sections/Data Sheets.

	GLOBAL STANDARD	Page 11 of 182
	POWER TRANSFORMERS	<b>GST002</b> Rev. 01 15/01/2014

## 5.15 LOSSES AND SHORT CIRCUIT IMPEDANCES

Short circuit impedances are given in Local Section.

Losses can be prescribed by giving maximum values and/or capitalized values.

For the European distribution companies the EU Directive related to the efficiency of the transformer and the relevant losses shall be fulfilled – See Annex D.

When maximum losses values are prescribed, they are given in Local Sections.

When the capitalization of losses applies, the related capitalization factors are specified in the offer request. The capitalization of losses is given by:

$$C_c = C + A \times P_v + B \times P_j$$

Where:

$C_c$  is the capitalized cost of the transformer (expressed in local currency)

$C$  is the cost declared by the Manufacturer in the offer (expressed in local currency)

$A$  is the no-load loss factor (expressed in local currency per kW) <sup>(1)</sup>

$B$  is the load loss factor (expressed in local currency per kW) <sup>(1)</sup>

$P_v$  is the no-load loss declared by the Manufacturer (expressed in kW)

$P_j$  is the load loss declared by the Manufacturer (expressed in kW)

<sup>(1)</sup> Values given at tender stage

### 5.15.1 Losses penalties

If the measured losses exceed the prescribed values and/or declared by the Manufacturer, within the tolerance admitted by IEC 60076-1, penalties will be applied.

If the losses exceed the maximum tolerance limits admitted by IEC 60076-1, the transformer is rejected.

In case of maximum losses, for the prototypes in the homologation/certification stage, no tolerance is admitted.

The calculation of the penalties to apply to the single transformer is the following:

$$L_v = 2 \times A \times \Delta P_v$$

$$L_j = 2 \times B \times \Delta P_j$$

Where:

$L_v$  penalties for no-load losses excess (expressed in local currency);

$L_j$  penalties for load losses excess (expressed in local currency);

$\Delta P_v$  difference between measured no-load losses and no-load losses declared by the Manufacturer (kW);

$\Delta P_j$  difference between measured load losses and load losses declared by the Manufacturer (kW).

	GLOBAL STANDARD	Page 12 of 182
	POWER TRANSFORMERS	<b>GST002</b> Rev. 01 15/01/2014

### 5.16 OVER-EXCITATION CONDITIONS

In compliance with IEC 60076-1.

Moreover, the transformer shall be able to operate at no-load with a magnetic flux in the core increased by the 10% of the nominal magnetic flux (therefore, the prescriptions relevant to the off-load current and the over-temperature of the core shall take into account such an over-excitation condition).

### 5.17 NO-LOAD CURRENT

The no-load current at the rated voltage shall be  $\leq 0,2$  % of the rated current.

On over-excitation condition, with the magnetic flux increased by 10 % of the nominal flux, the no-load current shall be  $\leq 0,5$  % of the rated current.

### 5.18 OVER-TEMPERATURE OF THE CORE

The surface over-temperature of the core shall not exceed 75 °C.

The above prescribed over-temperature shall be respected also in over-excitation conditions, with the magnetic flux increased by 10% of the nominal flux.

### 5.19 CAPABILITY TO WITHSTAND SHORT-CIRCUIT

The transformers shall be able to withstand the short circuit test in compliance with IEC 60076-5.

### 5.20 SOUND LEVELS

In compliance with IEC 60076-10.

The sound level of the transformers operating off-load and at rated voltage shall not be higher than the values prescribed by the relevant laws and standard; these values are reported in the Local Section and/or in the Data Sheets.

### 5.21 OVERALL DIMENSIONS

See Local Sections/Data Sheets.

	<b>GLOBAL STANDARD</b>	Page 13 of 182
	<b>POWER TRANSFORMERS</b>	<b>GST002</b> Rev. 01 15/01/2014

## 5.22 RATING PLATES

In compliance with IEC 60076-1.

Two rating plates shall be provided, according to the following indications, and shall be fixed on appropriate supports on the longer sides of the transformers, on exactly opposite positions.

If the supports are removable from the tank, the surface parts where they are fixed shall be painted in the same manner and shall comply with the same prescriptions of the whole tank.

The rating plates should be in local languages.

## 5.23 TOLERANCES

The admitted tolerances are the values prescribed in IEC 60076-1, if not otherwise specified.

On the sound power and pressure levels no tolerance is admitted.

## 6 DESIGN REQUIREMENTS

Unless otherwise specified, the transformers shall comply with IEC 60076-1 standard; the single parts of the transformers shall comply with the relevant standards.

### 6.1 CORE AND FRAME

The core and the frame shall be connected to ground on the external part of tank (usually the cover) by two proper bushings. Such connections inside the tank shall be made with insulated copper wirings of proper section (taking into account the value of the short circuit current and in any case not less than 50 mm<sup>2</sup>).

Possible magnetic shields have to be connected to ground in the same way, by an additional third bushing, or directly to the tank where leaned down.

The above mentioned bushings shall be connected to the ground on the cover tank, in a box easily accessible such that to facilitate the verification of the insulation level.

### 6.2 WINDINGS

The windings shall be made with electrolytic copper conductors, insulated with paper, or with continuously transposed cables.

In case of continuously transposed cables resin bonded, a sample shall be provided for each winding in order to check the polymerization degree reached during the treatment. The procedure for the verification of the polymerization degree is reported in the chapter 8.2.1.1 relevant to the tests.

### 6.3 HV AND MV NEUTRAL

See Local Sections/Data Sheets.

	GLOBAL STANDARD	Page 14 of 182
	POWER TRANSFORMERS	<b>GST002</b> Rev. 01 15/01/2014

#### **6.4 TANK**

The tank shall be manufactured such that to not allow neither the water accumulation on the external surface nor gas/air accumulation below the cover and inside the tank.

The tank shall be vacuum proof.

The tank shall not show appreciable permanent deflections as prescribed in vacuum test and in relevant standard.

The withstanding of the different joints (tank-cover, tank-flanges, cover-flanges, etc) shall be made through seal-gasket able to withstand the hot oil.

The screws shall be made by either hot-dip galvanized steel or by stainless steel; for diameters  $\leq$  M10 they shall be made of stainless steel.

All the materials of the tank shall be chosen to prevent corrosion processes.

The couplings of the tank and the different pipes shall be made with uninterrupted metallic connections to guarantee the metallic continuity.

#### **6.5 INSULATING LIQUID AND MATERIAL**

The insulating liquid shall be compliant to IEC 60296, class "U", without any anti-oxidant additive.

The oil shall not contain PCB.

It is forbidden the use of any mineral oil which presents characteristics such that to make it be classified as dangerous substance.

The oil Supplier and the oil type shall be both clearly indicated in the rating plate and/or in the manual.

#### **6.6 MV WIDINGS CONNECTIONS CHANGE**

See Local Sections/Data Sheets.

#### **6.7 COOLING SYSTEM**

Transformers cooling system are usually ONAN, ONAN/ONAF, OFAF.

Specific indications are given in Local Sections.

#### **6.8 ACCESSORIES AND AUXILIARIES**

See Local Sections.

	GLOBAL STANDARD	Page 15 of 182
	POWER TRANSFORMERS	<b>GST002</b> Rev. 01 15/01/2014

## 6.9 MARSHALLING BOX

See Local Sections.

## 6.10 PROTECTIVE PAINTING

The external painting of transformers and metallic accessories made of iron materials shall be obtained by using the following epoxy or polyurethane painting cycle:

**TABLE 1 – PAINTING CYCLE**

Pollution level	Base layer (µm)	Cover layer (µm)	Total thickness (µm)
Paint 1 – Medium	≥ 60	≥ 60	≥ 120
Paint 2 – Heavy or Very Heavy	≥ 80	≥ 80	≥ 160
Paint 3 – Extra Very Heavy	≥ 80 + 80 <sup>(1)</sup>	≥ 60 <sup>(2)</sup>	≥ 220

<sup>(1)</sup> Base layer – Primer-epoxy with zinc: 80 µm + Epoxy-polyamide micaceous iron oxide: 80 µm

<sup>(2)</sup> Cover layer – Polyurethane aliphatic: 60 µm

NOTE: alternatively the painting may be made by one layer of the same total thickness. Mono-component galvanized layers are also accepted.

Internal surfaces of the transformers shall be protected by a hot oil resistant painting (epoxy-polyamine or equivalent), ≥ 30 µm thick.

The surfaces to be painted shall be prepared by Manufacturer practice with suitable sandblasting or chemical cleaning (degreasing) treatments, specific for the painting cycle adopted.

The paint must be free of lead oxides or chromates. The safety and technical data sheets of the painting shall be provided by the Manufacturer.

The colour to be used is prescribed in Local Sections.

The reports and tests aimed to verify the good quality and the process of the painting cycle shall be provided by the Manufacturer.

	<b>GLOBAL STANDARD</b>	Page 16 of 182
	<b>POWER TRANSFORMERS</b>	<b>GST002</b> Rev. 01 15/01/2014

## 7 MAIN COMPONENTS

The Manufacturer of the transformer shall provide all the documentation to demonstrate the compliance of the components to this Global Standard and to the relevant standard.

### 7.1 BUSHINGS GENERAL REQUIREMENTS

The insulators could be requested by Enel Group Distribution companies in ceramic or composite materials. In case of ceramic insulators, they shall be in brown colour and compliant with IEC 62155. In case of composite insulators, they shall be in light grey colour and compliant with IEC 61462. The envelope shall be made of silicone rubber, HTV type (High Temperature Vulcanized) or LSR type and completely free of EPDM or other organic rubbers.

The flanges and the external metallic parts not made by stainless steel or not protected by zinc-coated or anti-oxidant substances shall be painted with the same protective paint prescribed for the tank.

The bushings shall be positioned accordingly to the layouts reported in the Local Sections.

All the hollow insulators shall be manufactured in one piece only, without any intermediate flange or joint.

All the metallic parts shall be in aluminium alloy, stainless steel, or hot galvanized.

The screws and the other small parts shall be made by stainless material.

All the bushings shall not have any spark gap shaft.

#### 7.1.1 HV Bushings

##### 7.1.1.1 Ratings

According to the transformer ratings.

##### 7.1.1.2 Design requirements

The flange and the junction for the connection of the external cable – in the coupling transformer/SF6 – shall be designed accordingly to IEC 62271-209.

The impregnating or filling liquids shall be environmentally compatible.

##### 7.1.1.3 Overall dimensions

See Local Sections/Data Sheets.

##### 7.1.1.4 Tests

IEC 60137 applies, unless otherwise specified.

#### 7.1.2 MV Bushings

##### 7.1.2.1 Ratings

According to the transformer ratings.



	GLOBAL STANDARD	Page 17 of 182
	POWER TRANSFORMERS	<b>GST002</b> Rev. 01 15/01/2014

### 7.1.2.2 Design Requirements

See Local Sections.

### 7.1.2.3 Overall dimensions

The overall dimensions of the bushings shall be in compliance with the relevant standard, if any.

### 7.1.2.4 Tests

IEC 60137 applies, unless otherwise specified.

## 7.2 ON LOAD TAP CHANGER

The scope of the present chapter is to define the technical-functional parameters, the design requirements and the tests definitions of the on-load tap changers to be used for the voltage regulation.

### 7.2.1 Ratings

Unless otherwise specified, IEC 60214-1 applies.

The on-load tap changer can be requested either vacuum tap type or oil-immersed type. See Local Sections.

The on-load tap changers with the change-over selector can be either fine-coarse type or reversing type.

### 7.2.2 Design Requirements

Unless otherwise specified, IEC 60214-1 applies.

#### 7.2.2.1 Painting

The external paint of the motor drive box and of the flange of the divert switch" shall comply the same requirements of the external painting of the transformer, except colour.

#### 7.2.2.2 Maintenance

The OLTC shall be able to work without any maintenance before **300.000** commutations for vacuum type and **100.000** for oil type.



This prescription shall not limit the normal service conditions and the lifetime (the OLTC Supplier shall give evidence of the compliance with this requirement).

#### 7.2.2.3 Functional requirements

See Local Sections.

### 7.2.3 Tests

According to IEC 60214-1.

 	GLOBAL STANDARD	Page 18 of 182
	POWER TRANSFORMERS	<b>GST002</b> Rev. 01 15/01/2014

## 8 TESTS

Unless otherwise specified, IEC 60076-1 applies.

### 8.1 LIST AND CLASSIFICATION OF TESTS

#### 8.1.1 Routine tests

- 1) Check of the correspondence with the approved prototype.
- 2) Measurement of winding resistance.
- 3) Measurement of voltage ratio and check of phase displacement.
- 4) Measurement of short-circuit impedance and load loss (11.4).
- 5) Measurement of no-load loss and current (11.5).
- 6) Dielectric routine tests (IEC 60076-3).
- 7) Tests on on-load tap changer, where appropriate (11.7).
- 8) Leak testing with pressure for liquid-immersed transformers (tightness test) (11.8).
- 9) Check of the ratio and polarity of built-in current transformers.
- 10) Check of core and frame insulation for liquid immersed transformers with core or frame insulation (11.12).
- 11) Measurement of d.c insulation resistance between each winding to earth and between windings.
- 12) Check and verification of the functionalities of accessories.
- 13) Insulating Oil tests.
- 14) Determination of sound level (IEC 60076-10) for each method of cooling for which a guaranteed sound level is specified.
- 15) Check of external coating (ISO 2178 and ISO 2409 or as specified).

#### 8.1.2 Additional routine tests for transformers with $U_m \geq 72,5$ KV

- 16) Determination of capacitances windings-to-earth and between windings.
- 17) Measurement of dissipation factor ( $\tan \delta$ ) of the insulation system capacitances.
- 18) Measurement of frequency response (Frequency Response Analysis or FRA).

#### 8.1.3 Type tests

- 1) Evaluation of the compliance with the specification requirements.
- 2) Temperature-rise type test (IEC 60076-2).
- 3) Dielectric type tests (IEC 60076-3).
- 4) Measurement of the power taken by the fan and liquid pump motors, if any.

	GLOBAL STANDARD	Page 19 of 182
	POWER TRANSFORMERS	<b>GST002</b> Rev. 01 15/01/2014

#### 8.1.4 Special tests

- 1) Dielectric special tests (IEC 60076-3).
- 2) Determination of transient voltage transfer characteristics (Annex B of IEC 60076-3:2013).
- 3) Measurement of zero-sequence impedance(s) on three-phase transformers.
- 4) Short-circuit withstand test (IEC 60076-5).
- 5) Vacuum deflection test on liquid immersed transformers.
- 6) Pressure test on liquid immersed transformers.

#### 8.1.5 General statements for the tests

For Certification, Homologation or Approval, all the routine tests, additional routine tests, type tests and special tests shall be performed on one unit of identical transformers which have the same GS type code, if not otherwise specified. Such statement does not include the short circuit test for which the criteria are given in the following sub-clause.

The repetition of type and special tests can be optionally requested for already homologated/certificated/ approved transformer types, in addition to the required routine tests.

Further tests in addition to the ones listed above can be requested to the transformers Manufacturer in case of particular technologies adopted.

##### 8.1.5.1 Short circuit test criteria

The short circuit test is required in compliance with IEC 60076-5 and in accordance to the following criteria.

For each type of transformers, the capability to withstand the short circuit test can be verified by calculation, based on a test performed on a similar transformer, in compliance with IEC 60076-5 Annex B.

Such verification is acceptable only if the short circuit test certificate on the similar transformer is more recent than 5 years.

## 8.2 TEST DESCRIPTION

The prescriptions and the tests conditions shall be compliant with the reference standards, unless otherwise specified.

The transformers shall be completely assembled (as in operation) during the tests, except in case of oil/SF<sub>6</sub> or oil/oil HV bushings whose criteria are given in the relevant standards.

### 8.2.1 Routine tests

#### 8.2.1.1 Check of the correspondence with the approved prototype

The ratings and the design requirements of the transformer under test (including bushings, tap changer, accessories, etc.) shall be compared with the approved prototype drawings.

The visual inspection shall also be performed in order to verify the absence of imperfections and defects.

	GLOBAL STANDARD	Page 20 of 182
	POWER TRANSFORMERS	<b>GST002</b> Rev. 01 15/01/2014

In case of continuously transposed cable (CTC) is used, the mechanical performance of the witnesses of the windings wires with respect to the one checked on the approved prototype shall be verified. The mechanical behaviour is determined through the flexion characterization (graph “arch-arrow” up to breakdown).

#### **8.2.1.2 Measurement of winding resistance**

According to IEC 60076-1 (11.2).

#### **8.2.1.3 Measurement of voltage ratio and check of phase displacement**

According to IEC 60076-1 (11.3).

For transformers with different voltage configurations (double MV voltage etc), the measurement shall be performed on each voltage position. For type of transformers homologated or certificated, submitted only to routine tests, the test can be performed on the delivering configuration.

#### **8.2.1.4 Measurement of short-circuit impedance and load loss**

According to IEC 60076-1 (11.4).

#### **8.2.1.5 Measurement of no-load loss and current**

According to IEC 60076-1 (11.5).

The measurements shall be performed at 90 %, 100% and 110 % of rated voltage.

#### **8.2.1.6 Dielectric routine tests**

According to IEC 60076-3.

In case of different voltage configurations, the dielectric routine tests shall be performed in the delivering configuration or in the most stressed configuration by agreement.

#### **8.2.1.7 Tests on on-load tap changer, where appropriate**

According to IEC 60076-1 (11.7).

#### **8.2.1.8 Leak testing with pressure for liquid-immersed transformers (tightness test)**

According to IEC 60076-1 (11.8).

#### **8.2.1.9 Check of the ratio and polarity of built-in current transformers**

According to IEC 60076-1.

To be performed only in case of built-in current transformers.

#### **8.2.1.10 Check of core and frame insulation for liq. Im. Transf. With core or frame insulation**

According to IEC 60076-1 (11.12).

#### **8.2.1.11 Measurement of d.c. ins. Res. Between each winding to earth and between windings**

According to IEC 60076-1.

	GLOBAL STANDARD	Page 21 of 182
	POWER TRANSFORMERS	<b>GST002</b> Rev. 01 15/01/2014

#### **8.2.1.12 Check and verification of the components and accessories.**

It shall be verified that all the components and accessories are properly installed on all the electric circuit connections and AC voltage insulation check to earth at 2 kV for 1 minute shall be performed.

The documentation (check and validation) of the sub-Supplier that confirms the compliance of the components and accessories to the related standard shall be provided by the Manufacturer.

#### **8.2.1.13 Insulating oil tests**

The compliance to IEC 60422 shall be verified on a sample of the oil taken by the transformer.

#### **8.2.1.14 Determination of sound level**

According to IEC 60076-10, for each method of cooling for which a guaranteed sound level is specified.

#### **8.2.1.15 Check of external coating**

According to ISO 2178 and ISO 2409 or as specified.

### **8.2.2 Additional routine tests for transformers with $U_m \geq 72,5$ kV**

#### **8.2.2.1 Determination of capacitances windings-to-earth and between windings**

According to IEC 60076-1.

#### **8.2.2.2 Measurement of dissipation factor ( $\tan \delta$ ) of the insulation system capacitances**

According to IEC 60076-1.

#### **8.2.2.3 Measurement of frequency response (FRA).**

According to IEC 60076-18.

### **8.2.3 Type tests**

#### **8.2.3.1 Evaluation of the compliance with the specification requirements**

The evaluation of conformity shall be performed through the comparison between the characteristics and the documentation of the transformer under test, and the specifications stated in the present GS concerning the ratings and the design requirements (accessories, control cabinet, painting cycles etc).

For what concerns the main subcomponents, the compliance of the bushings and the on-load tap changer with the relevant prescriptions will be verified.

#### **8.2.3.2 Temperature-rise type test**

According to IEC 60076-2.

The hot spot value has to be determined during the test and reported in the test report.

	GLOBAL STANDARD	Page 22 of 182
	POWER TRANSFORMERS	<b>GST002</b> Rev. 01 15/01/2014

### 8.2.3.3 Dielectric type tests

According to IEC 60076-3.

### 8.2.3.4 Measurement of the power taken by the fan and liquid pump motors, if any

According to IEC 60076-1.

## 8.2.4 Special tests

### 8.2.4.1 Dielectric special tests

According to IEC 60076-3.

### 8.2.4.2 Determination of transient voltage transfer characteristics

According to Annex B of IEC 60076-3.

### 8.2.4.3 Measurement of zero-sequence impedance(s) on three-phase transformers

According to IEC 60076-1 (11.6).

### 8.2.4.4 Short-circuit withstand test

According to IEC 60076-5.

### 8.2.4.5 Vacuum deflection test on liquid immersed transformers

According to IEC 60076-1 (11.9)

### 8.2.4.6 Pressure test on liquid immersed transformers

According to IEC 60076-1 (11.10)

## 9 SUPPLY REQUIREMENTS

Unless otherwise specified, IEC 60076-1 applies.

### 9.1 TRANSPORT

The transport of the transformer shall be made according to the local legislation of each country.

The transformer, during the transport from the Factory to the Substation, shall be equipped with an impact recorder made available by the Supplier.

When received the impact recorder recording shall be checked and, in case of solicitations stronger than 1 g, the Manufacturer shall verify by a proper method the good transformer conditions.

	GLOBAL STANDARD	Page 23 of 182
	POWER TRANSFORMERS	<b>GST002</b> Rev. 01 15/01/2014

## 9.2 COMMISSIONING

Before the first energization the Manufacturer shall perform all the tests and verifications necessary to ensure the proper state and configuration of the transformer.

An appropriate form shall be released after energization.

See Local Sections.

## 9.3 DOCUMENTATION

### 9.3.1 Documentation for the offer

The technical documentation to be produced by the Supplier for the economical offer shall contain the following items:

- 1) Description of the product.
- 2) Short circuit test and related Manufacturer report for validation.
- 3) The data requested in the form of Annex C.

The full compliance to the prescriptions indicated in this document and relevant standards of the main components and the accessories shall be ensured by the Manufacturer.

Each Distribution Company will verify and approve the relevant documentation during the homologation, certification or approval process.

Each exception to the present document and to the related ones shall be expressly evidenced during the technical offer submission, otherwise it will not be considered and the related apparatus not accepted.

### 9.3.2 Documentation for homologation, certification and approval

The Supplier, for each transformer type code to be subjected to homologation, certification or approval procedure, shall make available a complete documentation containing calculations, drawings, schemas, pictures of the HV and MV side, internal and external, descriptions, list of characteristics, performances, assembling, maintenance and operational norms and whatever necessary for the complete acknowledgment of the transformer.

All the final technical documentation shall be delivered in electronic form.

#### 9.3.2.1 Not-reserved documentation (Type A)

This is the documentation issued by the Manufacturer that allows to verify, directly or indirectly, the compliance of the transformer with the prescription of the GS. The Manufacturer authorizes the diffusion and the reproduction of this documentation within the Distribution Companies.

It shall contain at least:

- 1) List of all the documents, including the list of the reserved documentation (type B).
- 2) List of the Suppliers of the main components and parts.
- 3) Manual of the transport, installation, operation and maintenance (in local language).
- 4) Drawing of the rating plates (in local language).

	<b>GLOBAL STANDARD</b>	Page 24 of 182
	<b>POWER TRANSFORMERS</b>	<b>GST002</b> Rev. 01 15/01/2014

- 5) Overall drawings and relevant details of both the completely assembled transformer (as in operation) and of the transformer transportation.
- 6) Drawing of the auxiliaries circuits (in local language).
- 7) Test reports of the transformer.
- 8) Test reports and certifications of the subcomponents and materials used.
- 9) External pictures.
- 10) Calculation of the capability to withstand the short circuit (in case of the test is not performed).
- 11) The data requested in the form of Annex C updated and validated after the homologation, certification or approval process.

Together with each transformer supplied (compliant to the relevant approved type), the Supplier shall deliver the documentations listed in the items 3, 5, 6, 7, integrated with the auto-certification of the absence of PCB.

#### **9.3.2.2 Reserved documentation (Type B)**

It is the documentation considered reserved, of which the Supplier does not authorize the diffusion, used to completely identify the design and the manufacturing of the transformer. It shall include all the elements required in this GS and the documentation of the origins of the materials not reported in "not-reserved documentation". Such documentation will be overviewed by the company's representatives or by the certification body during the homologation or certification and will be archived by the Supplier.

#### **9.4 GUARANTY**

The minimal requested guarantee period is 5 years.

The guarantee period starts after the factory tests for the transformer acceptance.

The transformer Supplier guarantees the transformers and all the sub-components with respect to all the defects.

In case of defects on the protective coating the Distribution Company can require the protective coating re-painting by the transformers manufacture to its own cost.

The transformers in operation are managed with a proper maintenance and their conditions are also verified by the criteria based on Dissolve Gas Analysis on oil samples.

In case of identification of a clear fault condition in accordance to IEC 60599 the transformers Manufacturer has to recondition the transformer, on its own cost, in order to re-establish the proper conditions.

#### **10 EXCEPTIONS**

Possible exceptions to the present prescriptions, concerning the adoption of technical and/or manufacturing aspects different from the ones prescribed in the present GS, can be evaluated by the Distribution Company.

In such a case, the Distribution Company will take into account the opportunity to require additional tests with regard to the technical/manufacturing proposed solutions.



Such exceptions can be approved by the Distribution Company only.



	GLOBAL STANDARD	Page 25 of 182
	POWER TRANSFORMERS	GST002 Rev. 01 15/01/2014

## 11 FIGURES

Figures and drawings are reported in the relevant Local Section.

 	<b>GLOBAL STANDARD</b>	Page 26 of 182
	<b>POWER TRANSFORMERS</b>	<b>GST002</b> Rev. 01 15/01/2014

## ANNEX A – COMMON LIST

### ITALY

GST002 Type Code	Country	Country ID	TR or ATR	Ph (n)	f (Hz)	n. of wind.	Connect. Symbol	Sr (MVA)	Cooling System	Service Condition IEC 60076-1	Rated Voltage (kV)			Bushings Connection Type		
											HV	MV	MV2	HV	MV	MV2
GST002/001	Italy	116101	TR	3P	50	2	Yyn0	16	ONAN	Normal	132	15,6	--	O/A	O/A	--
GST002/002	Italy	116102	TR	3P	50	2	Yyn0	16	ONAN	Normal	132	20,8	--	O/A	O/A	--
GST002/003	Italy	116103	TR	3P	50	2	Yyn0	16	ONAN	Normal	132	20,8-10,4	--	O/A	O/A	--
GST002/004	Italy	116104	TR	3P	50	2	Yyn0	16	ONAN	Normal	150	15,6	--	O/A	O/A	--
GST002/005	Italy	116105	TR	3P	50	2	Yyn0	16	ONAN	Normal	150	20,8	--	O/A	O/A	--
GST002/006	Italy	116106	TR	3P	50	2	Yyn0	16	ONAN	Normal	150	20,8-10,4	--	O/A	O/A	--
GST002/007	Italy	116111	TR	3P	50	2	Yyn0	25	ONAN	Normal	132	15,6	--	O/A	O/A	--
GST002/008	Italy	116112	TR	3P	50	2	Yyn0	25	ONAN	Normal	132	20,8	--	O/A	O/A	--
GST002/009	Italy	116113	TR	3P	50	2	Yyn0	25	ONAN	Normal	132	20,8-10,4	--	O/A	O/A	--
GST002/010	Italy	116114	TR	3P	50	2	Yyn0	25	ONAN	Normal	150	15,6	--	O/A	O/A	--
GST002/011	Italy	116115	TR	3P	50	2	Yyn0	25	ONAN	Normal	150	20,8	--	O/A	O/A	--
GST002/012	Italy	116116	TR	3P	50	2	Yyn0	25	ONAN	Normal	150	20,8-10,4	--	O/A	O/A	--
GST002/013	Italy	116121	TR	3P	50	2	Yyn0	25	ONAN	Normal	132	15,6	--	O/O	O/A	--
GST002/014	Italy	116122	TR	3P	50	2	Yyn0	25	ONAN	Normal	132	20,8	--	O/O	O/A	--
GST002/015	Italy	116123	TR	3P	50	2	Yyn0	25	ONAN	Normal	132	20,8-10,4	--	O/O	O/A	--
GST002/016	Italy	116124	TR	3P	50	2	Yyn0	25	ONAN	Normal	150	15,6	--	O/O	O/A	--
GST002/017	Italy	116125	TR	3P	50	2	Yyn0	25	ONAN	Normal	150	20,8	--	O/O	O/A	--
GST002/018	Italy	116126	TR	3P	50	2	Yyn0	25	ONAN	Normal	150	20,8-10,4	--	O/O	O/A	--
GST002/019	Italy	116131	TR	3P	50	2	Yyn0	25	ONAN	Normal	132	15,6	--	O/S	O/A	--
GST002/020	Italy	116132	TR	3P	50	2	Yyn0	25	ONAN	Normal	132	20,8	--	O/S	O/A	--
GST002/021	Italy	116133	TR	3P	50	2	Yyn0	25	ONAN	Normal	132	20,8-10,4	--	O/S	O/A	--
GST002/022	Italy	116134	TR	3P	50	2	Yyn0	25	ONAN	Normal	150	15,6	--	O/S	O/A	--
GST002/023	Italy	116135	TR	3P	50	2	Yyn0	25	ONAN	Normal	150	20,8	--	O/S	O/A	--
GST002/024	Italy	116136	TR	3P	50	2	Yyn0	25	ONAN	Normal	150	20,8-10,4	--	O/S	O/A	--
GST002/025	Italy	116141	TR	3P	50	2	Yyn0	40	ONAN	Normal	132	15,6	--	O/A	O/A	--
GST002/026	Italy	116142	TR	3P	50	2	Yyn0	40	ONAN	Normal	132	20,8	--	O/A	O/A	--
GST002/027	Italy	116143	TR	3P	50	2	Yyn0	40	ONAN	Normal	132	20,8-10,4	--	O/A	O/A	--





POWER TRANSFORMERS

GST002  
Rev. 01  
15/01/2014

ITALY

GST002 Type Code	Country	Country ID	TR or ATR	Ph (n)	f (Hz)	n. of wind.	Connect. Symbol	Sr (MVA)	Cooling System	Service Condition IEC 60076-1	Rated Voltage (kV)			Bushings Connection Type		
											HV	MV	MV2	HV	MV	MV2
GST002/028	Italy	116144	TR	3P	50	2	Yyn0	40	ONAN	Normal	150	15,6	--	O/A	O/A	--
GST002/029	Italy	116145	TR	3P	50	2	Yyn0	40	ONAN	Normal	150	20,8	--	O/A	O/A	--
GST002/030	Italy	116146	TR	3P	50	2	Yyn0	40	ONAN	Normal	150	20,8-10,4	--	O/A	O/A	--
GST002/031	Italy	116151	TR	3P	50	2	Yyn0	40	ONAN	Normal	132	15,6	--	O/O	O/A	--
GST002/032	Italy	116152	TR	3P	50	2	Yyn0	40	ONAN	Normal	132	20,8	--	O/O	O/A	--
GST002/033	Italy	116153	TR	3P	50	2	Yyn0	40	ONAN	Normal	132	20,8-10,4	--	O/O	O/A	--
GST002/034	Italy	116154	TR	3P	50	2	Yyn0	40	ONAN	Normal	150	15,6	--	O/O	O/A	--
GST002/035	Italy	116155	TR	3P	50	2	Yyn0	40	ONAN	Normal	150	20,8	--	O/O	O/A	--
GST002/036	Italy	116156	TR	3P	50	2	Yyn0	40	ONAN	Normal	150	20,8-10,4	--	O/O	O/A	--
GST002/037	Italy	116161	TR	3P	50	2	Yyn0	40	ONAN	Normal	132	15,6	--	O/S	O/A	--
GST002/038	Italy	116162	TR	3P	50	2	Yyn0	40	ONAN	Normal	132	20,8	--	O/S	O/A	--
GST002/039	Italy	116163	TR	3P	50	2	Yyn0	40	ONAN	Normal	132	20,8-10,4	--	O/S	O/A	--
GST002/040	Italy	116164	TR	3P	50	2	Yyn0	40	ONAN	Normal	150	15,6	--	O/S	O/A	--
GST002/041	Italy	116165	TR	3P	50	2	Yyn0	40	ONAN	Normal	150	20,8	--	O/S	O/A	--
GST002/042	Italy	116166	TR	3P	50	2	Yyn0	40	ONAN	Normal	150	20,8-10,4	--	O/S	O/A	--
GST002/043	Italy	116171	TR	3P	50	2	Yyn0	63	ONAN	Normal	132	15,6	--	O/A	O/A	--
GST002/044	Italy	116172	TR	3P	50	2	Yyn0	63	ONAN	Normal	132	20,8	--	O/A	O/A	--
GST002/045	Italy	116173	TR	3P	50	2	Yyn0	63	ONAN	Normal	150	15,6	--	O/A	O/A	--
GST002/046	Italy	116174	TR	3P	50	2	Yyn0	63	ONAN	Normal	150	20,8	--	O/A	O/A	--
GST002/047	Italy	116181	TR	3P	50	2	Yyn0	63	ONAN	Normal	132	15,6	--	O/O	O/A	--
GST002/048	Italy	116182	TR	3P	50	2	Yyn0	63	ONAN	Normal	132	20,8	--	O/O	O/A	--
GST002/049	Italy	116183	TR	3P	50	2	Yyn0	63	ONAN	Normal	150	15,6	--	O/O	O/A	--
GST002/050	Italy	116184	TR	3P	50	2	Yyn0	63	ONAN	Normal	150	20,8	--	O/O	O/A	--
GST002/051	Italy	116191	TR	3P	50	2	Yyn0	63	ONAN	Normal	132	15,6	--	O/S	O/A	--
GST002/052	Italy	116192	TR	3P	50	2	Yyn0	63	ONAN	Normal	132	20,8	--	O/S	O/A	--
GST002/053	Italy	116193	TR	3P	50	2	Yyn0	63	ONAN	Normal	150	15,6	--	O/S	O/A	--
GST002/054	Italy	116194	TR	3P	50	2	Yyn0	63	ONAN	Normal	150	20,8	--	O/S	O/A	--

 	<b>GLOBAL STANDARD</b>	Page 28 of 182
	<b>POWER TRANSFORMERS</b>	<b>GST002</b> Rev. 01 15/01/2014

### ROMANIA

GST002 Type Code	Country	Country ID	TR or ATR	Ph (n)	f (Hz)	n. of wind.	Connect. Symbol	Sr (MVA)	Cooling System	Service Condition IEC 60076-1	Rated Voltage (kV)			Bushings Connection Type		
											HV	MV	MV2	HV	MV	MV2
GST002/101	Romania	611409	TR	3P	50	2	YnD11	16	ONAN	Special	115	10,4	--	O/A	O/A	--
GST002/102	Romania	611406	TR	3P	50	2	YnD11	16	ONAN	Special	115	20,8	--	O/A	O/A	--
GST002/103	Romania	611407	TR	3P	50	2	YnD11	16	ONAN	Special	115	20,8-10,4	--	O/A	O/A	--
GST002/104	Romania	611410	TR	3P	50	2	YnD11	25	ONAN	Special	115	10,4	--	O/A	O/A	--
GST002/105	Romania	611404	TR	3P	50	2	YnD11	25	ONAN	Special	115	20,8	--	O/A	O/A	--
GST002/106	Romania	611402	TR	3P	50	2	YnD11	25	ONAN	Special	115	20,8-10,4	--	O/A	O/A	--
GST002/107	Romania	611411	TR	3P	50	2	YnD11	40	ONAN	Special	115	10,4	--	O/A	O/A	--
GST002/108	Romania	611405	TR	3P	50	2	YnD11	40	ONAN	Special	115	20,8	--	O/A	O/A	--
GST002/109	Romania	611403	TR	3P	50	2	YnD11	40	ONAN	Special	115	20,8-10,4	--	O/A	O/A	--
GST002/110	Romania	611412	TR	3P	50	2	YnD12	63	ONAN	Special	115	20,8	--	O/A	O/A	--



POWER TRANSFORMERS

GST002  
Rev. 01  
15/01/2014

SPAIN

GST002 Type Code	Country	Country ID	TR or ATR	Ph (n)	f (Hz)	n. of wind.	Connect. Symbol	Sr (MVA)	Cooling System	Service Condition IEC 60076-1	Rated Voltage (kV)			Bushings Connection Type		
											HV	MV	MV2	HV	MV	MV2
GST002/201	Spain (CAT)	6710831	TR	3P	50	3	YNyn6yn6	63/31,5/31,5	ONAN/AF	Normal	230	11,4	11,4	O/A	O/A	O/A
GST002/202	Spain (CAT)	6710832	TR	3P	50	3	YNd11yn6	63/63/31,5	ONAN/AF	Normal	230	26,4	11,4	O/A	O/A	O/A
GST002/203	Spain (CAT)	6710833	TR	3P	50	2	YNd11	50/63	ONAN/AF	Normal	230	26,4	--	O/A	Plug-in	--
GST002/204	Spain (SUR)	6710834	TR	3P	50	2	YNyn0	50/63	ONAN/AF	Special	230	22	--	O/A	Plug-in	--
GST002/205	Spain (SUR)	6710835	TR	3P	50	2	YNyn0	32/40	ONAN/AF	Special	132	22	--	O/A	Plug-in	--
GST002/206	Spain (SUR)	6710836	TR	3P	50	2	YNd11	32/40	ONAN/AF	Special	132	15,6	--	O/A	Plug-in	--
GST002/207	Spain (SUR)	6710837	TR	3P	50	2	YNyn0	20/25	ONAN/AF	Special	132	22	--	O/A	Plug-in	--
GST002/208	Spain (SUR)	6710838	TR	3P	50	2	YNd11	20/25	ONAN/AF	Special	132	15,6	--	O/A	Plug-in	--
GST002/209	Spain (SUR)	6710839	TR	3P	50	2	YNyn0	12,5/16	ONAN/AF	Special	132	22	--	O/A	Plug-in	--
GST002/210	Spain (SUR)	6710840	TR	3P	50	2	YNd11	12,5/16	ONAN/AF	Special	132	15,6	--	O/A	Plug-in	--
GST002/211	Spain (CAT/ARA)	6710841	TR	3P	50	2	YNd11	32/40	ONAN/AF	Normal	132	26,4	--	O/A	Plug-in	--
GST002/212	Spain (CAT/ARA)	6710842	TR	3P	50	2	YNd11	32/40	ONAN/AF	Normal	110	26,4	--	O/A	Plug-in	--
GST002/213	Spain (CAT/ARA)	6710843	TR	3P	50	2	YNd11	20/25	ONAN/AF	Normal	132	26,4	--	O/A	Plug-in	--
GST002/214	Spain (CAT/ARA)	6710844	TR	3P	50	2	YNd11	20/25	ONAN/AF	Normal	110	26,4	--	O/A	Plug-in	--
GST002/215	Spain (CAT/ARA)	6710845	TR	3P	50	2	YNd11	12,5/16	ONAN/AF	Normal	132	26,4	--	O/A	Plug-in	--
GST002/216	Spain (CAT/ARA)	6710846	TR	3P	50	2	YNd11	12,5/16	ONAN/AF	Normal	110	26,4	--	O/A	Plug-in	--
GST002/217	Spain (ARA)	6710847	TR	3P	50	2	YNyn0	32/40	ONAN/AF	Normal	132	15,7	--	O/A	Plug-in	--
GST002/218	Spain (ARA)	6710848	TR	3P	50	2	YNd11	20/25	ONAN/AF	Normal	132	10,25	--	O/A	Plug-in	--
GST002/219	Spain (ARA)	6710849	TR	3P	50	2	YNyn0	20/25	ONAN/AF	Normal	132	15,7	--	O/A	Plug-in	--
GST002/220	Spain (ARA)	6710850	TR	3P	50	2	YNyn0	12,5/16	ONAN/AF	Normal	132	15,7	--	O/A	Plug-in	--
GST002/221	Spain (ARA)	6710851	TR	3P	50	2	YNd11	12,5/16	ONAN/AF	Normal	132	10,25	--	O/A	Plug-in	--
GST002/222	Spain (BAL)	6710852	TR	3P	50	2	YNd11	40	ONAN	Normal	132	16,6	--	O/A	Plug-in	--
GST002/223	Spain (BAL)	6710853	TR	3P	50	2	YNd11	25	ONAN	Normal	132	16,6	--	O/A	Plug-in	--
GST002/224	Spain (BAL)	6710854	TR	3P	50	2	YNd11	16	ONAN	Normal	132	16,6	--	O/A	Plug-in	--
GST002/225	Spain (ARA)	6710855	TR	3P	50	2	YNd11	20/25	ONAN/AF	Normal	132	21	--	O/A	Plug-in	--
GST002/226	Spain (ARA)	6710856	TR	3P	50	2	YNd11	12,5/16	ONAN/AF	Normal	132	21	--	O/A	Plug-in	--
GST002/227	Spain (ARA)	6710857	TR	3P	50	2	YNd11	32/40	ONAN/AF	Normal	132	21	--	O/A	Plug-in	--



POWER TRANSFORMERS

GST002  
Rev. 01  
15/01/2014

SPAIN

GST002 Type Code	Country	Country ID	TR or ATR	Ph (n)	f (Hz)	n. of wind.	Connect. Symbol	Sr (MVA)	Cooling System	Service Condition IEC 60076-1	Rated Voltage (kV)			Bushings Connection Type		
											HV	MV	MV2	HV	MV	MV2
GST002/228	Spain (ARA)	6710858	TR	3P	50	2	YNyn0	20/25	ONAN/AF	Normal	47	15,7	--	Plug-in	Plug-in	--
GST002/229	Spain (ARA)	6710859	TR	3P	50	2	YNd11	20/25	ONAN/AF	Normal	47	10,25	--	Plug-in	Plug-in	--
GST002/230	Spain (ARA)	6710860	TR	3P	50	2	YNyn0	12,5/16	ONAN/AF	Normal	47	15,7	--	Plug-in	Plug-in	--
GST002/231	Spain (ARA)	6710861	TR	3P	50	2	YNd11	12,5/16	ONAN/AF	Normal	47	10,25	--	Plug-in	Plug-in	--
GST002/232	Spain (ARA)	6710862	TR	3P	50	2	YNyn0	32/40	ONAN/AF	Normal	47	15,7	--	Plug-in	Plug-in	--
GST002/233	Spain (ARA)	6710863	TR	3P	50	2	YNd11	20/25	ONAN/AF	Normal	47	21	--	Plug-in	Plug-in	--
GST002/234	Spain (ARA)	6710864	TR	3P	50	2	YNd11	12,5/16	ONAN/AF	Normal	47	21	--	Plug-in	Plug-in	--
GST002/235	Spain (ARA)	6710865	TR	3P	50	2	YNd11	12,5/16	ONAN/AF	Normal	66	13,8	--	O/A	Plug-in	--
GST002/236	Spain (BAL)	6710911	TR	3P	50	2	YNd11	40	ONAN	Special	68,16	16,6	--	O/A	Plug-in	--
GST002/237	Spain (CAN)	6710874	TR	3P	50	2	YNd1	32/40	ONAN/AF	Special	63	22	--	O/A	Plug-in	--
GST002/238	Spain (SUR)	6710866	TR	3P	50	2	YNyn0	12,5/16	ONAN/AF	Special	66	22	--	O/A	Plug-in	--
GST002/239	Spain (SUR)	6710867	TR	3P	50	2	YNyn0	32/40	ONAN/AF	Special	66	22	--	O/A	Plug-in	--
GST002/240	Spain (SUR)	6710868	TR	3P	50	2	YNyn0	20/25	ONAN/AF	Special	66	22	--	O/A	Plug-in	--
GST002/241	Spain (SUR)	6710869	TR	3P	50	2	YNd11	20/25	ONAN/AF	Special	66	15,6	--	O/A	Plug-in	--
GST002/242	Spain (SUR)	6710870	TR	3P	50	2	YNd11	12,5/16	ONAN/AF	Special	66	15,6	--	O/A	Plug-in	--
GST002/243	Spain (CAT)	6705861	TR	3P	50	3	YNyn0d11	315/315/80	OFAF	Normal	400	132-110	26,4	O/A	O/A	O/A
GST002/244	Spain (CAT)	6705862	ATR	3P	50	3	YNy0(d11)	200/200/50	OFAF	Normal	230	132-110	26,4	O/A	O/A	O/A
GST002/245	Spain (SUR-ARA)	6710871	ATR	3P	50	3	YNy0(d11)	160/160/40	ONAN/AF	Special	230	138	9,5	O/A	O/A	O/A
GST002/246	Spain (CAT/ARA/ SUR)	6705835	TR	3P	50	3	YNy0(d11)	125/125/31,5	ONAN/AF	Special	230	68	10,5	O/A	O/A	O/A
GST002/247	Spain (CAN/BAL)	6705833	TR	3P	50	3	YNy0(d11)	125/125/20	ONAN/AF	Special	230	68	6,3	O/A	O/A	O/A
GST002/248	Spain (ARA)	6705834	TR	3P	50	3	YNy0(d11)	100/100/31,5	ONAN/AF	Normal	230	47	9,5	O/A	O/A	O/A
GST002/249	Spain (SUR)	6710872	TR	3P	50	3	YNy0(d11)	80/80/31,5	ONAN/AF	Special	132	70	10,5	O/A	O/A	O/A
GST002/250	Spain (ARA)	6710873	TR	3P	50	3	YNy0(d11)	80/80/25	ONAN/AF	Normal	132	47	9,5	O/A	Plug-in	O/A
GST002/251	Spain (CAT)	6706091	TR	3P	50	3	YNyn6yn6	63/31,5/31,5	ONAN/AF	Normal	230	11,4	11,4	O/A	O/A	O/A
GST002/252	Spain (CAT)	6705832	TR	3P	50	3	YNd11yn6	63/63/31,5	ONAN/AF	Normal	230	26,4	11,4	O/A	O/A	O/A
GST002/253	Spain (CAT)	6706771	TR	3P	50	2	YNd11	63	ONAN/AF	Normal	230	26,4	--	O/A	Plug-in	--
GST002/254	Spain (SUR)	6706494	TR	3P	50	2	YNyn0 (d11)	63	ONAN/AF	Special	230	22	--	O/A	Plug-in	--



POWER TRANSFORMERS

GST002  
Rev. 01  
15/01/2014

SPAIN

GST002 Type Code	Country	Country ID	TR or ATR	Ph (n)	f (Hz)	n. of wind.	Connect. Symbol	Sr (MVA)	Cooling System	Service Condition IEC 60076-1	Rated Voltage (kV)			Bushings Connection Type		
											HV	MV	MV2	HV	MV	MV2
GST002/255	Spain (SUR-ARA)	6706754	ATR	3P	50	3	YNy0(d11)	160/160/40	ONAN/AF	Special	230	138	10,5	O/A	O/A	O/A
GST002/256	Spain (SUR)	6705293	TR	3P	50	2	YNyn0- d11(d11)	40/40/10	ONAN/AF	Special	132	27-15,6	15,6	O/A	Plug-in	O/A
GST002/257	Spain (SUR)	6706721	TR	3P	50	2	YNyn0- d11(d11)	20/20/5	ONAN/AF	Special	132	27-15,6	--	O/A	Plug-in	--
GST002/258	Spain (SUR)	6705300	TR	3P	50	3	YNy0(d11)	80/80/31,5	ONAF	Special	132	70	10,5	O/A	O/A	O/A
GST002/259	Spain (CAT/ARA)	6705294	TR	3P	50	2	YNd11	40	ONAN/AF	Normal	132-110	26,4	--	O/A	Plug-in	--
GST002/260	Spain (ARA)	6705297	TR	3P	50	2	YNyn0- d11	40	ONAN/AF	Normal	132	16,45-9,5	--	O/A	Plug-in	--
GST002/261	Spain (ARA)	6705296	TR	3P	50	2	YNyn0- d11	25	ONAN/AF	Normal	132	16,45-9,5	--	O/A	Plug-in	--
GST002/262	Spain (BAL)	6706092	TR	3P	50	2	YNd11	40	ONAN	Normal	132	16,6	--	O/A	Plug-in	--
GST002/263	Spain (ARA)	6705298	TR	3P	50	2	YNd11	25	ONAN/AF	Normal	132	20	--	O/A	Plug-in	--
GST002/264	Spain (ARA)	6705280	TR	3P	50	2	YNd11	40	ONAN/AF	Normal	132	20	--	O/A	Plug-in	--
GST002/265	Spain (ARA)	6705291	TR	3P	50	3	YNy0(d11)	80/80/25	ONAN/AF	Normal	132	47	9,5	O/A	Plug-in	O/A
GST002/266	Spain (ARA)	6705860	TR	3P	50	2	YNd11	20	ONAN	Normal	66	13,8	--	O/A	Plug-in	--
GST002/267	Spain (BAL)	6705854	TR	3P	50	2	YNd11	40	ONAN	Special	68,16	16,52	--	O/A	Plug-in	--
GST002/268	Spain (CAN)	6705855	TR	3P	50	2	YNd1	40	ONAF	Special	66	22	--	O/A	Plug-in	--
GST002/269	Spain (SUR)	6706021	TR	3P	50	2	YNyn0	40	ONAF	Special	66	22	--	O/A	Plug-in	--
GST002/270	Spain (SUR)	6706495	TR	3P	50	2	YNyn0	20	ONAF	Special	66	22	--	O/A	Plug-in	--



POWER TRANSFORMERS

GST002  
Rev. 01  
15/01/2014

LATAM

GST002 Type Code	Country	Country ID	TR or ATR	Ph (n)	f (Hz)	n. of wind.	Connect. Symbol	Sr (MVA)	Cooling System	Service Condition IEC 60076-1	Rated Voltage (kV)			Bushings Connection Type		
											HV	MV	MV2	HV	MV	MV2
GST002/401	Argentina	ES-0102-0468	TR	3P	50	2	YNyn0	20/40	ONAF	Normal	132	13,86	--	O/A	O/A	--
GST002/402	Argentina	ES-0102-1378	TR	3P	50	2	YNyn0	40/80	ONAF	Normal	132	13,86	--	O/A	O/A	--
GST002/501	Peru	EN-6805129	TR	3P	60	3	YNynd11	180	ONAF	Normal	200	62,46	12	O/A	O/A	O/A
GST002/502	Peru	EN-6800054	TR	1P	60	2	YNyn0	60	ONAF	Normal	200/ $\sqrt{3}$	62,46/1,73	--	O/A	O/A	--
GST002/503	Peru	EN-6790228	TR	3P	60	2	YNd5	30/40	ONAF	Normal	58	10,05	--	O/A	O/A	--
GST002/504	Peru	EN-6790229	TR	3P	60	3	YNynd5	20/25	ONAF	Normal	58	20	10,05	O/A	O/A	O/A
GST002/505	Peru	EN-6790240	TR	3P	60	3	YNynd5	30/40	ONAF	Normal	58	20	10,05	O/A	O/A	O/A
GST002/506	Peru	EN-6805140	TR	3P	60	3	YNynd5	20/25	ONAF	Normal	62,52	20	10,05	O/A	O/A	O/A
GST002/507	Peru	EN-6758180	TR	3P	60	2	YNd5	20/25	ONAF	Normal	58	10,05	--	O/A	O/A	--
GST002/601	Brazil	CE-4544202	TR	3P	60	2	Dyn1	5/6,25/7,5	ONAN/ONAF1/ ONAF2	Normal	69,3	13,8	--	O/A	O/A	--
GST002/602	Brazil	CE-4544204	TR	3P	60	2	Dyn1	10/12,5/15	ONAN/ONAF1/ ONAF2	Normal	69,3	13,8	--	O/A	O/A	--
GST002/603	Brazil	CE-4544186	TR	3P	60	2	Dyn1	20/26,6/33,3	ONAN/ONAF1/ ONAF2	Normal	69,3	13,8	--	O/A	O/A	--
GST002/701	Colombia	CD	TR	3P	60	2	YNyn0	30/35/40	ONAF	Special	115	34,5	--	O/A	O/A	--
GST002/702	Colombia	CD	TR	3P	60	2	YNyn0	30/35/40	ONAF	Special	115	12	--	O/A	O/A	--
GST002/703	Colombia	CD	TR	3P	60	2	YNyn0	34/45/56	ONAF	Special	230	12	--	O/A	O/A	--
GST002/704	Colombia	CD	TR	3P	60	2	YNyn0	30/35/40	ONAF	Special	230	34,5	--	O/A	O/A	--
GST002/705	Colombia	CD	ATR	1P	60	3	Yna0d	90/120/150	ONAF	Special	500// $\sqrt{3}$	120//3	11,4	O/A	O/A	O/A
GST002/706	Colombia	CD	ATR	1P	60	3	Yna0d	60/80/100	ONAF	Special	230// $\sqrt{3}$	120//3	13,8	O/A	O/A	O/A
GST002/707	Colombia	CD	ATR	1P	60	3	Yna0d	34/45/56	ONAF	Special	230//3	115//3	13,8	O/A	O/A	O/A







POWER TRANSFORMERS

GST002  
Rev. 01  
15/01/2014

LATAM



GST002 Type Code	Country	Country ID	TR or ATR	Ph (n)	f (Hz)	n. of wind.	Connect. Symbol	Sr (MVA)	Cooling System	Service Condition IEC 60076-1	Rated Voltage (kV)			Bushings Connection Type		
											HV	MV	MV2	HV	MV	MV2
GST002/801	Chile	CH	TR	3P	50	2	Dyn1	30/40/50	ONAF	Normal	110	12,5	--	O/A	O/A	--
GST002/802	Chile	CH	TR	3P	50	2	Dyn1	30/40/50	ONAF	Normal	110	23,5-12,5		O/A	O/A	--
GST002/803	Chile	CH	TR	3P	50	2	Dyn1	30/40/50	ONAF	Normal	110	23,5	--	O/A	O/A	--
GST002/804	Chile	CH	TR	3P	50	2	Dyn1	50	ONAN	Normal	110	12,5	--	O/A	O/A	--
GST002/805	Chile	CH	TR	3P	50	2	Dyn1	50	ONAN	Normal	110	23,5-12,5		O/A	O/A	--
GST002/806	Chile	CH	TR	3P	50	2	Dyn1	50	ONAN	Normal	110	23,5	--	O/A	O/A	--
GST002/807	Chile	CH	TR	3P	50	2	Dyn1	50	ONAN	Normal	220	23,5	--	O/A	O/A	--
GST002/808	Chile	CH	TR	3P	50	2	Dyn1	30/40/50	ONAF	Normal	220	23,5	--	O/A	O/A	--
GST002/809	Chile	CH	ATR	1P	50	3	Yna0d1	100/133/ Tertiary 30-40	ONAF	Normal	220/√3	110/√3	34,5	O/A	O/A	O/A
GST002/810	Chile	CH	ATR	1P	50	3	Yna0d1	100/133/ Tertiary 30-40	ONAF	Normal	220/√3	110/√3	13,2	O/A	O/A	O/A
GST002/901	Brazil	AM-6772434	TR	3P	60	2	Dyn1	20/26,6/33,3	ONAF	Normal	138	13,8-1,95	--	O/A	O/A	--
GST002/902	Brazil	AM-6790494	TR	3P	60	2	Dyn1	10/12,5/15	ONAF	Normal	138	13,8-1,95	--	O/A	O/A	--
GST002/903	Brazil	AM-6803003	TR	3P	60	2	Dyn1	25/33,3/41,6	ONAF	Normal	138	34,5	--	O/A	O/A	--
GST002/904	Brazil	AM-6773189	TR	3P	60	2	Dyn1	15/20	ONAF	Normal	138	34,5	--	O/A	O/A	--
GST002/905	Brazil	AM-6772448	TR	3P	60	2	Dyn1	15/20/25	ONAF	Normal	69	13,8-1,95	--	O/A	O/A	--
GST002/906	Brazil	AM-6772536	TR	3P	60	2	Dyn1	10/12,5	ONAF	Normal	69	13,8-1,95	--	O/A	O/A	--
GST002/907	Brazil	AM-6772464	TR	3P	60	2	Dyn1	10/12,5/15	ONAF	Normal	69	34,5	--	O/A	O/A	--
GST002/908	Brazil	AM-6772466	TR	3P	60	2	Dyn1	5/6,25/7,5	ONAF	Normal	34,5	13,8-1,95	--	O/A	O/A	--
GST002/909	Brazil	AM-6797994	ATR	3P	60	2	Ynad1	66/83/ Tertiary 15-20	ONAF	Normal	138	69	13,8-1,95	O/A	O/A	O/A

 	GLOBAL STANDARD	Page 34 of 182
	POWER TRANSFORMERS	<b>GST002</b> Rev. 01 15/01/2014

## ANNEX B – DATA SHEET FORM

(example of template)

Country	
Country Code	
TR or ATR	
N° of phases	
f (Hz)	
N. of windings	
Connection Symbol	
Rated Power $S_r$ (MVA) - for different cooling system and more MV	
Cooling System	
Installation	
Service conditions 60076-1	
Ref. Temp. 60076-2; Table 1,2 (K)	
Rated HV $U_r$ (kV)	
HV insulation levels ( $U_m$ -BIL-IND-AC) (kV)	
HV neutral (inside/outside)	
HV neutral (Insul. Levels) (kV)	
HV Volt. Reg. Type (OLTC-DETC-NO)	
HV Volt. Reg. (n. of steps, value %)	
MV Rated Voltage $U_r$ (kV)	
MV insulation ( $U_m$ -LI-AC)	
MV Neutral (inside-outside)	
MV Neutral (insul levels)	
MV Volt. Reg Type (DETC-intank bars-NO)	
MV Volt reg (n°step, value%)	
MV2 Rated Voltage $U_r$ (kV)	
MV2 insulation ( $U_m$ -LI-AC)	
MV2 Neutral (inside - outside)	
MV2 Neutral (insul levels)	
MV2 Volt. Reg Type (DETC – in tank bars - NO)	
MV2 Volt reg (n. of steps, value%)	
Tertiary for compensation (description)	
$Z_{sc}$ HV-MV (% rif. $S_r$ )	
$Z_{sc}$ HV-MV2 (%, rif. $S_r$ )	
$Z_{sc}$ MV-MV2 (%, rif $S_r$ )	
Load Loss HV-MV (kW)	
No Load Loss HV-MV (kW)	
Load Loss HV-MV2 (kW)	
No Load Loss HV-MV2(kW)	
Sound Level (to indicate if given in sound power or pressure)	
HV bushing type	
MV bushing type	

 	GLOBAL STANDARD	Page 35 of 182
	POWER TRANSFORMERS	<b>GST002</b> Rev. 01 15/01/2014

MV2 bushing type	
Main Accessories	
Seismic requirement	
Dimensions	
Painting type	
Colour	
HV surge arrester support structure	

	GLOBAL STANDARD	Page 36 of 182
	POWER TRANSFORMERS	<b>GST002</b> Rev. 01 15/01/2014

## ANNEX C - TECHNICAL FORM

This form is used for evaluating the offer in the tender process and also for the technical data validation during the homologation, certification and approval procedure

Flag here the use of this form:       Offer in tender       Tech data validation

### IMPORTANT



This document has to be used for checking the compliance of the transformer during the tender process. Deviations are in principle not acceptable.

Possible deviations have to be clearly reported in the following form for specific deviations.



The acceptance of this document for the next tender stage does not mean the acceptance of any deviation to the technical specification if such deviations are not clearly reported in the form for specific deviations.

### RATINGS Part 1 of 5

RATINGS	Data Declared (if relevant, otherwise indicate "--")	Notes (add remarks, if necessary)
GS TYPE CODE	to indicate	
Country	to indicate	
Country Code	to indicate	
Transformer (TR) or auto-transformer (ATR)	to indicate	
N° of phases	to indicate	
Rated frequency fr (Hz)	to indicate	
Number of windings	to indicate	
Connection Symbol	to indicate	
Rated Power S <sub>r</sub> (MVA) - for each cooling system and more MV	to indicate	
Cooling System	to indicate	
Installation	indoor/outdoor	
Service conditions 60076-1	normal/special	
Ref. Temp. 60076-2; Table 1,2 (K)	oil/winding/hot-spot	
Rated HV U <sub>r</sub> (kV)	to indicate	
HV insul. levels - U <sub>m</sub> / SI / LI / LIC / AC (kV)	to indicate	
HV neutral (inside/outside)	to indicate	
HV neutral (Insulation levels) (kV)	to indicate	
HV Volt. Reg. Type (OLTC-DETC-NO)	to indicate	
HV Volt. Reg. (n. of steps, value %)	to indicate	
MV Rated Voltage U <sub>r</sub> (kV)	to indicate	
MV insulation levels (U <sub>m</sub> -LI-AC)	to indicate	
MV Neutral (inside-outside)	to indicate	
MV Neutral insulation levels	to indicate	
MV Volt. Reg. Type (DETC-intank bars-NO)	to indicate	
MV Voltage regulation (n°step, value%)	to indicate	



 	GLOBAL STANDARD	Page 37 of 182
	POWER TRANSFORMERS	<b>GST002</b> Rev. 01 15/01/2014

MV2 Rated Voltage Ur (kV)	to indicate	
MV2 insulation (Um-LI-AC)	to indicate	
MV2 Neutral (inside-outside)	to indicate	
MV2 Neutral (insulation levels)	to indicate	
MV2 Volt. reg type (DETC-intank bars-NO)	to indicate	
MV2 Volt reg (n. of steps, value%)	to indicate	
Tertiary for compensation (description)	to indicate	
Z <sub>sc</sub> HV-MV (% rif. S <sub>r</sub> )	to indicate	
Z <sub>sc</sub> HV-MV2 (%, rif. S <sub>r</sub> )	to indicate	
Z <sub>sc</sub> MV-MV2 (%, rif. S <sub>r</sub> )	to indicate	
Load Loss HV-MV (kW)	to indicate	
No Load Loss HV-MV (kW)	to indicate	
Load Loss HV-MV2 (kW)	to indicate	
No Load Loss HV-MV2 (kW)	to indicate	
Sound level (dB) (to specify if values ref. to power or pressure as requested)	to indicate	
Overall dimensions (cm)	to indicate	
Dimensional drawings to be attached	Indicate the ref. Number	
Transport drawings to be attached	Indicate the ref. Number	
Total Weights (Kg)	to indicate	
<b>Other parameters to be specified</b>		
to indicate	to indicate	

 	GLOBAL STANDARD	Page 38 of 182
	POWER TRANSFORMERS	<b>GST002</b> Rev. 01 15/01/2014

## MAIN COMPONENTS - Part 2 of 5

MAIN COMPONENTS	Data Declared (if relevant, otherwise indicate "--")	Notes (add remarks, if necessary)
<b>HV BUSHINGS</b>	<b>Phase - Neutral</b>	
Supplier	to indicate	
Type	to indicate	
$U_r$ (kV)	to indicate	
$I_r$ (A)	to indicate	
Creepage distance (mm)	to indicate	
hollow insulator type	polymeric, ceramic	
Tg $\delta$	to indicate	
Capacitive plug	yes/no	
<b>MV BUSHINGS</b>	<b>Phase - Neutral</b>	
Supplier	to indicate	
Type	to indicate	
$U_r$ (kV)	to indicate	
$I_r$ (A)	to indicate	
Creepage distance (mm)	to indicate	
hollow insulator Type	polymeric, ceramic	
Tg $\delta$	to indicate	
<b>TAP CHANGER</b>		
ON LOAD / DE ENERGIZED	to indicate	
Supplier	to indicate	
Model and type	to indicate	
Number of steps	to indicate	
Rated step voltage (V)	to indicate	
Rated operating current (A)	to indicate	
Commutation resistance (W)	to indicate	
Rated maximum current - $I_{um}$ (A)	to indicate	
Highest voltage for equipment - $U_m$ (kV)	to indicate	
<b>VOLTAGE LEVEL CHANGE</b>		
DOUBLE VOLTAGE	yes/no	
Y-D	yes/no	

 	<b>GLOBAL STANDARD</b>	Page 39 of 182
	<b>POWER TRANSFORMERS</b>	<b>GST002</b> Rev. 01 15/01/2014

### MAIN ACCESSORIES - Part 3 of 5



<b>MAIN ACCESSORIES</b>	<b>Data Declared</b> (if relevant, otherwise indicate "--")	<b>Notes</b> (add remarks, if necessary)
<b>RADIATORS</b>		
Supplier	to indicate	
Type	to indicate	
Numbers of radiators	to indicate	
Total dispersive surface (m <sup>2</sup> all radiators)	to indicate	
Radiators thickness (mm)	to indicate	
Painting Cycle	to indicate	
Standard reference	to indicate	
<b>BUTTERFLY VALVES</b>		
Supplier	to indicate	
Type	to indicate	
Standard reference		
<b>FANS</b>		
Supplier	to indicate	
Type	to indicate	
Number	to indicate	
Standard reference	to indicate	
<b>OIL</b>		
Supplier	to indicate	
Type	to indicate	
Standard reference	to indicate	
Inhibitors or antioxidant additives	yes/no	
Same transformer oil used for OLTC	yes/no	
Buchholz	to indicate (Supplier/type)	
Oil Level Indicator	to indicate (Supplier/type/number)	
Silica gel or Dehydrating breather	to indicate (Supplier/type/number)	
Overpressure valve	to indicate (Supplier/type/number)	

	<b>GLOBAL STANDARD</b>	Page 40 of 182
	<b>POWER TRANSFORMERS</b>	<b>GST002</b> Rev. 01 15/01/2014



## DESIGN DATA - Part 4 of 5

<b>DESIGN DATA</b>	<b>Data Declared</b> (if relevant, otherwise indicate "--")	<b>Notes</b> (add remarks, if necessary)
<b>CORE</b>		
Thin core sheets type (e.g. 30M0H)	to indicate	
Induction (T) at rated voltage	to indicate	
Core Supplier	to indicate	
Core joint type (e.g. Step-Lap/6 layers/2 sheets per layer)	to indicate	
Oil channels (number and dimensions, if any)	to indicate	
Minimum insulation thickness for both faces	to indicate	
Maximum permissible rough edge of sheet	to indicate	
Core weight	to indicate	
Magnetic losses of core sheets - Epstein Test (W/kg)	to indicate	
Type of insulation of the core sheets	to indicate	
<b>FRAME</b>		
Type (brief descriptions of the topology)	to indicate	
Material of the frame	to indicate	
Contact typology (e.g. turn opened/closed)	to indicate	
Frame vs. core insulating material	to indicate	
Number of press-limb elements per phase	to indicate	
Windings tightening torque type (e.g. rigid/elastic)	to indicate	
Weight	to indicate	
Final Windings tightening torque (kN)	to indicate	
<b>WINDINGS</b>	<b>Primary - Secondary</b>	
Windings type (e.g. interleaved, helical etc)	to indicate	
Type of conductors (e.g. strand, CTC etc)	to indicate	
Weight of the copper (kg)	to indicate	
Current density at $S_r$ and $U_r$ ( $A/mm^2$ )	to indicate	
Single conductor	to indicate	
thickness (mm)	to indicate	
height (mm)	to indicate	
insulation (mm)	to indicate	
Hardening degree $\sigma$ 0,2 ( $N/mm^2$ )	to indicate	
Axial cooling channels thickness (mm)	to indicate	
Radial cooling channels thickness (mm)	to indicate	
Radial dimension of the winding (mm)	to indicate	
Axial dimension of the winding (mm)	to indicate	
Conductors Supplier	to indicate	





 	<b>GLOBAL STANDARD</b>	Page 41 of 182
	<b>POWER TRANSFORMERS</b>	<b>GST002</b> Rev. 01 15/01/2014

<b>Other windings</b>	<b>2<sup>nd</sup> Secondary - Tertiary</b>	
Windings type (e.g. interleaved, helical etc)	to indicate	
Type of conductors (e.g. strand, CTC etc)	to indicate	
Weight of the copper (kg)	to indicate	
Current density at S <sub>r</sub> and Un (A/mm <sup>2</sup> )	to indicate	
Single conductor	to indicate	
Thickness (mm)	to indicate	
Height (mm)	to indicate	
Insulation (mm)	to indicate	
Hardening degree $\sigma$ 0,2 (N/mm <sup>2</sup> )	to indicate	
Axial cooling channels thickness (mm)	to indicate	
Radial cooling channels thickness (mm)	to indicate	
Radial dimension of the winding (mm)	to indicate	
Axial dimension of the winding (mm)	to indicate	
Conductors Supplier	to indicate	
<b>MAGNETIC SHIELDS (if any)</b>		
Material type	to indicate	
Blocks thickness	to indicate	
Number per phase	to indicate	
Possible solution to prevent the tank heating due to zero-sequence current (description)	to indicate	
<b>INSULATING STRUCTURES/MATERIALS</b>		
Insulating paper type	to indicate	
Insulating paper weight (kg)	to indicate	
Insulating paper Supplier	to indicate	
Type of insulating of mounted winding (es. cylinders stanches)	to indicate	
Supplier of insulating of mounted windings	to indicate	
Type of extremities supports (insulating rings)	to indicate	
Ends of windings supports Suppliers	to indicate	
Type of supports for the connections	to indicate	
Supplier of he supports for the connections	to indicate	
<b>TANK</b>		
Type of iron sheet used	to indicate	
Tank weight (kg)	to indicate	
Tank Supplier	to indicate	
<b>ACTIVE PART TREATMENT</b>		
Type (product code)	to indicate	
Scheduled duration	to indicate	
Final check - extracted water quantity (l)	to indicate	

 	GLOBAL STANDARD	Page 42 of 182
	POWER TRANSFORMERS	<b>GST002</b> Rev. 01 15/01/2014

<b>PAINTING CYCLE</b>		
Layers (e.g. bottom + intermediate + final)	to indicate	
Thickness (single layers and total)	to indicate	
Supplier	to indicate	
Type (product code)	to indicate	
<b>WEIGHTS (kg)</b>		
Copper	to indicate	
Core (magnetic steel)	to indicate	
Other Iron parts (frame, tank etc)	to indicate	
Paper insulating material	to indicate	
Oil (as in operation)	to indicate	
Active part	to indicate	
Total	to indicate	
Total in transport configuration	to indicate	
<b>Other relevant data</b>		
to indicate	to indicate	

 	GLOBAL STANDARD	Page 43 of 182
	POWER TRANSFORMERS	<b>GST002</b> Rev. 01 15/01/2014

**FORM FOR SPECIFIC DEVIATIONS – Part 5 of 5**

Each specific deviation shall be reported and explained here below  
 (to be indicated with a progressive number)

- **NO DEVIATIONS** (to flag in case of no deviations from the technical specification - Global Standard)

**DEVIATION 1**

---



---



---

**DEVIATION 2**

---



---



---

**DEVIATION ...**

With reference to all the 5 parts of this form, add here:

Date \_\_\_\_\_

Sign \_\_\_\_\_

	GLOBAL STANDARD	Page 44 of 182
	POWER TRANSFORMERS	<b>GST002</b> Rev. 01 15/01/2014

## ANNEX D - LOSSES PRESCRIPTION RELATED TO THE EU REGULATION

For the European countries, the performance efficiency of the transformers shall comply with the related European Commission Regulation on Implementing Directive 2009/125/C regarding small, medium and large power transformers (presently in progress - it will be in force from July 2015).

The related prescriptions are based on the document in progress and the method and the values to be respected in the European countries are reported here below

### DEFINITIONS

#### loading factor (k)

the ratio of actual input current over the rated current of transformer. Normally  $0 \leq k \leq 1$

#### transmitted apparent power (kS<sub>r</sub>)

the product of the loading factor and the rated power

#### Efficiency Index (EI)

the ratio of the transmitted apparent power of a transformer minus electrical losses to the transmitted apparent power of the transformer

#### Peak Efficiency Index (PEI)

the highest value of efficiency index that can be achieved at the optimum value of loading factor

#### loading factor of Peak Efficiency Index (k<sub>PEI</sub>)

the loading factor at which Peak Efficiency Index occurs

### EFFICIENCY INDEX – GENERAL FORMULA

The Efficiency Index is calculated in accordance with equation 1:

$$EI = \frac{kS_r - (P_0 + P_{c0}) - (k^2P_k + P_{ck}(k))}{kS_r} \quad (\text{pu})$$

Equation 1

Where:

$P_0$  is the no load loss measured at rated voltage and rated frequency, on the rated tap.

$P_{c0}$  is the electrical power required by the cooling system for no load operation derived from the type test measurements of the power taken by the fan and liquid pump motors.

$P_k$  is the measured load loss at rated current and rated frequency on the rated tap corrected to reference temperature according to EN 60076-1.

$P_{ck}(k)$  is the additional electrical power required (in addition to  $P_{c0}$ ) by the cooling system for operation at k time the rated load derived from the type test measurements of the power taken by the fan and liquid pump motors.

$S_r$  is the rated power of the transformer or autotransformer on which  $P_k$  is based

k is the loading factor

The derivation of  $P_{c0}$  from the type test measurements of the power consumption of the full cooling system for fans and pumps which are either on or off is done by multiplying the proportion of fans and pumps expected to be in service for no load operation by the total power consumption of the fans and the pumps respectively. If fans and pumps have variable speed drives, an additional type test measurement may be required to determine  $P_{c0}$ . Similar provisions are applied for the derivation of  $P_{ck}(k)$ . No routine measurements of cooling power consumption are required.

For PEI calculation, the following shall be considered.

	GLOBAL STANDARD	Page 45 of 182
	POWER TRANSFORMERS	<b>GST002</b> Rev. 01 15/01/2014

- a) The reference temperature for liquid immersed transformers with rated average winding temperature rise less than or equal to 65 K for OF or ON, or 70 K for OD is 75°C.
- b) For liquid immersed transformers with other rated average winding temperature rise, the reference temperature is equal to the rated average winding temperature rise + 20 °C, or rated winding temperature rise + yearly external cooling medium average temperature, whichever is higher.

### PEAK EFFICIENCY INDEX (PEI)

The Peak Efficiency Index is obtained when no-load loss equals load loss (see Annex A) and is given by replacing  $k=k_{PEI}$  in equation 1 by equation 2 below:

$$k_{PEI} = \sqrt{\frac{P_0 + P_{c0}}{P_k}} \quad (\text{pu})$$

The formula to be used for Peak Efficiency Index calculation is therefore defined by equation 3:

$$PEI = 1 - \frac{2(P_0 + P_{c0})}{S_r \sqrt{\frac{P_0 + P_{c0}}{P_k}}} \quad (\text{pu})$$

The Peak Efficiency Index includes the losses associated with the cooling system that is in service continuously. This assumes that at the loading for peak loss performance index only this cooling will be in service and the cooling required to achieve rated power is switched off.

### MINIMUM PEAK EFFICIENCY VALUES

The Minimum PEI values to be respected for liquid immersed transformers are given below.

Sr (MVA)	PEI (%)
≤ 4	99,465
5	99,483
6,3	99,510
8	99,535
10	99,560
12,5	99,588
16	99,615
20	99,639
25	99,657
31,5	99,671
40	99,684
50	99,696
63	99,709
80	99,723
≥ 100	99,737

	GLOBAL STANDARD	Page 46 of 182
	POWER TRANSFORMERS	<b>GST002</b> Rev. 01 15/01/2014

For rated powers different from the ones reported in the table, the corresponding PEI value can be obtained by linear interpolation from the two adjacent values.

Three phase or single phase transformers shall be evaluated against the rated power of the individual transformer.



### **RATING PLATE DATA**

In addition to EN 60076-1 requirements, the following values shall be shown on the rating plate:

- PEI based on measurements;
- $k_{PEI}$ , the loading factor at which PEI occurs;
- $P_0$ , the no load loss measured at rated voltage and rated frequency, on the rated tap;
- $P_{c0}$ , the electrical power required by the cooling system for no load operation derived from the type test measurements of the power taken by the fan and liquid pump motors;
- $P_k$ , the measured loss at rated current and rated frequency on the rated tap corrected to reference temperature according to EN 60076-1.



### **TOLERANCES**

No tolerances are applicable to the PEI value as it is a minimum value calculated from actual measurements.

 	GLOBAL STANDARD	Page 47 of 182
	<b>POWER TRANSFORMERS</b> LOCAL SECTION LATAM	<b>GST002</b> Rev. 01 15/01/2014

## INDEX – LOCAL SECTION LATAM

<b>1</b>	<b>SCOPE</b> .....	<b>49</b>
<b>2</b>	<b>LIST OF COMPONENTS</b> .....	<b>49</b>
<b>3</b>	<b>REFERENCE LAWS AND STANDARDS</b> .....	<b>49</b>
<b>3.1</b>	<b>LAWS</b> .....	<b>49</b>
<b>3.2</b>	<b>INTERNATIONAL STANDARDS</b> .....	<b>49</b>
<b>3.3</b>	<b>LOCAL STANDARDS</b> .....	<b>49</b>
<b>3.4</b>	<b>OTHER RELEVANT DOCUMENTS</b> .....	<b>49</b>
<b>3.5</b>	<b>REPLACED STANDARDS</b> .....	<b>49</b>
<b>4</b>	<b>SERVICE CONDITIONS</b> .....	<b>50</b>
<b>5</b>	<b>RATINGS</b> .....	<b>50</b>
<b>5.1</b>	<b>TYPES OF TRANSFORMERS</b> .....	<b>50</b>
<b>5.2</b>	<b>NUMBER OF WINDINGS</b> .....	<b>50</b>
<b>5.3</b>	<b>NUMBER OF PHASES</b> .....	<b>50</b>
<b>5.4</b>	<b>COOLING SYSTEM</b> .....	<b>50</b>
<b>5.5</b>	<b>RATED POWER</b> .....	<b>50</b>
<b>5.6</b>	<b>RATED VOLTAGE</b> .....	<b>50</b>
<b>5.7</b>	<b>RATED FREQUENCY</b> .....	<b>50</b>
<b>5.8</b>	<b>VOLTAGE REGULATION</b> .....	<b>50</b>
<b>5.9</b>	<b>WINDINGS CONNECTIONS</b> .....	<b>50</b>
<b>5.10</b>	<b>INSTALLATION</b> .....	<b>50</b>
<b>5.11</b>	<b>HV AND MV NEUTRAL</b> .....	<b>50</b>
<b>5.12</b>	<b>OVER-LOAD CAPABILITY</b> .....	<b>50</b>
<b>5.13</b>	<b>BUSHINGS</b> .....	<b>50</b>
<b>5.14</b>	<b>INSULATION LEVELS</b> .....	<b>51</b>
<b>5.15</b>	<b>LOSSES AND SHORT CIRCUIT IMPEDANCES</b> .....	<b>51</b>
<b>5.16</b>	<b>OVER-EXCITATION CONDITIONS</b> .....	<b>51</b>
<b>5.17</b>	<b>NO-LOAD CURRENT</b> .....	<b>51</b>
<b>5.18</b>	<b>OVER-TEMPERATURE OF THE CORE</b> .....	<b>51</b>
<b>5.19</b>	<b>CAPABILITY TO WITHSTAND SHORT-CIRCUIT</b> .....	<b>51</b>
<b>5.20</b>	<b>SOUND POWER LEVELS</b> .....	<b>51</b>
<b>5.21</b>	<b>OVERALL DIMENSIONS</b> .....	<b>51</b>
<b>5.22</b>	<b>RATING PLATES</b> .....	<b>51</b>
<b>5.23</b>	<b>TOLERANCES</b> .....	<b>51</b>
<b>6</b>	<b>DESIGN REQUIREMENTS</b> .....	<b>52</b>
<b>6.1</b>	<b>CORE AND FRAME</b> .....	<b>52</b>
<b>6.2</b>	<b>WINDINGS</b> .....	<b>52</b>
<b>6.3</b>	<b>HV AND MV NEUTRAL</b> .....	<b>52</b>
<b>6.4</b>	<b>TANK</b> .....	<b>52</b>
<b>6.5</b>	<b>INSULATING LIQUID AND MATERIAL</b> .....	<b>53</b>
<b>6.6</b>	<b>MV WIDINGS CONNECTIONS CHANGE</b> .....	<b>53</b>
<b>6.7</b>	<b>COOLING SYSTEM</b> .....	<b>53</b>
<b>6.8</b>	<b>ACCESSORIES AND AUXILIARIES</b> .....	<b>54</b>
6.8.1	Valves.....	54
6.8.2	Current transformers (CT's).....	55



 	GLOBAL STANDARD	Page 48 of 182
	<b>POWER TRANSFORMERS</b> LOCAL SECTION LATAM	<b>GST002</b> Rev. 01 15/01/2014

6.8.3	Anchoring .....	56
6.8.4	Oil preservation system.....	56
6.8.5	No- Load Tap Changer (DETC).....	56
6.8.6	Protections .....	57
6.8.7	Instruments.....	57
6.8.8	surge arresters support .....	58
<b>6.9</b>	<b>MARSHALLING BOX.....</b>	<b>58</b>
<b>6.10</b>	<b>PROTECTIVE PAINTING.....</b>	<b>60</b>
<b>7</b>	<b>MAIN COMPONENTS .....</b>	<b>61</b>
<b>8.</b>	<b>TESTS.....</b>	<b>64</b>
<b>8.1</b>	<b>LIST AND CLASSIFICATION OF TESTS .....</b>	<b>64</b>
8.1.1	Routine tests .....	64
8.1.2	Additional routine tests for transformers with $U_m \geq 72,5$ KV .....	64
8.1.3	Type tests.....	64
8.1.4	Special tests .....	64
8.1.5	General statements for the tests .....	64
8.1.5.1	Short circuit test criteria.....	64
<b>9</b>	<b>SUPPLY REQUIREMENTS.....</b>	<b>65</b>
<b>9.1</b>	<b>TRANSPORT.....</b>	<b>65</b>
<b>9.2</b>	<b>COMMISSIONING.....</b>	<b>65</b>
<b>9.3</b>	<b>DOCUMENTATION.....</b>	<b>65</b>
<b>9.4</b>	<b>GUARANTY.....</b>	<b>65</b>
9.4.1	DEFECTIVENESS .....	66
9.4.2	PROTECTIVE COATING .....	66
9.4.3	TRANSFORMERS IN OPERATION .....	66
<b>10</b>	<b>EXCEPTIONS .....</b>	<b>66</b>
<b>11</b>	<b>FIGURES AND TABLES .....</b>	<b>66</b>
<b>11.1</b>	<b>OVERALL DIMENSIONS.....</b>	<b>67</b>
<b>11.2</b>	<b>BASE ANCHORING.....</b>	<b>68</b>
<b>11.3</b>	<b>CURRENT TRANSFORMERS IN BUSHINGS.....</b>	<b>70</b>
<b>11.4</b>	<b>PRINCIPAL ACCESSORIES LOCATION .....</b>	<b>72</b>
<b>11.5</b>	<b>BUSHINGS.....</b>	<b>73</b>

## ANNEXES

<b>B)</b>	<b>DATA SHEETS OF TRANSFORMER REQUIREMENTS.....</b>	<b>75</b>
-----------	---	-----------



 	<b>GLOBAL STANDARD</b>	Page 49 of 182
	<b>POWER TRANSFORMERS</b> LOCAL SECTION LATAM	<b>GST002</b> Rev. 01 15/01/2014

## 1 SCOPE

The scope of this document is to provide technical requirements for the supply of the power transformers to be used in the distribution networks of Latam.

The present document completes the Global Standard GST002.

## 2 LIST OF COMPONENTS

See Common List.

## 3 REFERENCE LAWS AND STANDARDS

### 3.1 LAWS

Brasil

- NR-10 - segurança em instalações e serviços em eletricidade

### 3.2 INTERNATIONAL STANDARDS

- IEC – 61869-1 General requirements for instrument transformers
- IEC – 61869-2 Additional requirements for current transformers
- IEC – 60450 Measurement of the average viscometric degree of polymerization of new and aged cellulosic electrically insulating materials
- IEC 60068-3-3 Environmental testing Parte 3: Guidance - Seismic test methods for equipments.



### 3.3 LOCAL STANDARDS

- Chilectra.
  - ETGI-1020 - ESPECIFICACIONES TÉCNICAS GENERALES - REQUISITOS DE DISEÑO SÍSMICO PARA EQUIPO ELECTRICO.
- Edelnor
  - E – SE – 010: “Acción sísmica en equipos eléctricos y mecánicos”

### 3.4 OTHER RELEVANT DOCUMENTS

### 3.5 REPLACED STANDARDS

E – SE – 001

 	<b>GLOBAL STANDARD</b>	Page 50 of 182
	<b>POWER TRANSFORMERS</b> LOCAL SECTION LATAM	<b>GST002</b> Rev. 01 15/01/2014

## 4 SERVICE CONDITIONS

### Specific service conditions

- a) Altitude.  
Colombia (Codensa). The reference altitude is 2.600 m.
- b) Seismic qualification level
  - Chilectra : ETGI-1020
  - Codensa
    - Seismic horizontal acceleration :0,3 g.
    - Seismic vertical acceleration:0,25 g
  - Edelnor : AG5- IEC 60068-3-3 or E-SE-010

## 5 RATINGS

### 5.1 TYPES OF TRANSFORMERS

See Data sheet

### 5.2 NUMBER OF WINDINGS

See Datsheet

### 5.3 NUMBER OF PHASES

See Data Sheet

### 5.4 COOLING SYSTEM

See Data Sheet

### 5.5 RATED POWER

See Data Sheet

### 5.6 RATED VOLTAGE

See Data Sheet

### 5.7 RATED FREQUENCY

See Data Sheet

### 5.8 VOLTAGE REGULATION

See Data Sheet

### 5.9 WINDINGS CONNECTIONS

See Data Sheet

### 5.10 INSTALLATION

See Data Sheet



### 5.11 HV AND MV NEUTRAL

The MV neutral connection shall be adapt for the connection of the neutral point with resistance or earthing reactor or direct grounded.

### 5.12 OVER-LOAD CAPABILITY

### 5.13 BUSHINGS

Copyright 2013. All rights reserved.

 	<b>GLOBAL STANDARD</b>	Page 51 of 182
	<b>POWER TRANSFORMERS</b> LOCAL SECTION LATAM	<b>GST002</b> Rev. 01 15/01/2014

The type of bushings are chosen accordingly to the transformer rated power, the rated voltage, the overload capability and the interfaces with terminals to overhead conductors in the substation.

The type and quantity of bushings to be used for the HV and MV terminals (three or four, one of which for the neutral ) will be indicated in Data sheet

The Bushing shall be adequate for pollution level of each company.

In the case porcelain bushing shall be brown

The bushings must be sized so as to allow the installation of current transformers (CT's) in each of them. The Supplier shall provide to distribution company the design drawing bushings to check the space for the CT's.

#### **5.14 INSULATION LEVELS**

See Data Sheet

The minimum distances between energized parts and earth, as well as the separations between phases must be determined by the insulations levels (see recommendations IEC 60071). These minimum distances in the air must be provided for the Supplier.

#### **5.15 LOSSES AND SHORT CIRCUIT IMPEDANCES**

The prescribes values for the losses and the short circuit impedances are given in the data sheet.

The impedance values of the transformer shall refer to the temperature of 75 C (IEC) and to the base power indicated respectively. The loss values shall refer to the same temperature as the impedance values (75°C)

#### **5.16 OVER-EXCITATION CONDITIONS**

#### **5.17 NO-LOAD CURRENT**

#### **5.18 OVER-TEMPERATURE OF THE CORE**

#### **5.19 CAPABILITY TO WITHSTAND SHORT-CIRCUIT**

#### **5.20 SOUND POWER LEVELS**

See Data sheet

#### **5.21 OVERALL DIMENSIONS**

The dimensions and the position of the main accessories, are shown in the figures listed and reported in 11.1 and 11.4 of this document.

#### **5.22 RATING PLATES**

The nameplate language shall be in Spanish for Codensa, Chilectra, Edelnor and Edesur and Portuguese for Ampla and Coelce. The name plate shall be submitted to the Distribution Company approval .

The accesories included in the transformer: Insulators (Bushings), OLTC, current transformers (including the destined to measuring temperature and voltage regulation), must have their nameplates in compliance with the corresponding standards, located in places that are easy to read by an operator.

#### **5.23 TOLERANCES**

	<b>GLOBAL STANDARD</b>	Page 52 of 182
	<b>POWER TRANSFORMERS</b> LOCAL SECTION LATAM	<b>GST002</b> Rev. 01 15/01/2014

## 6 DESIGN REQUIREMENTS

The transformers must be designed so as to be suitable to operate in parallel with other transformers of similar characteristics.

In the case of transformers with a delta tertiary compensator, the use of special reactors to limit the short circuit current is not acceptable.

The Supplier must inform about the inclusion of non-linear resistors or other accessory included in its design, which influence certain behaviors of the transformer, so this information must be made known to the Distribution Company.

All materials, components, and equipment incorporated into the transformers must be new and of the best quality, to ensure that the complete equipment complies with the continuous operation requirements during its entire useful life. The company could reject the elements or components that not comply with the requirements of this specification.

The Distribution Company reserves the right to realize programmed and unscheduled inspections, during the manufacturing process to verify the quality and characteristics of the materials, the manufacturing methods and request the quality certificates of the magnetic steel, the conductors, papers, oils, etc.

The transformer must resist the thermal and mechanical effects of the symmetric short circuit current.

Likewise, it must be capable of resisting all the impacts during its transport and assembly.

The fully assembled transformer must comply with the requirements specified for seismic action for the companies required.

### 6.1 CORE AND FRAME

### 6.2 WINDINGS

### 6.3 HV AND MV NEUTRAL

### 6.4 TANK

The cover shall not be welded to the main tank. In the design of the cover, the Supplier shall take special care in preventing the accumulation of rainwater.

The transformer shall include adequate hatches, for possible internal inspections (Manhole and Handhole accesses), with the minimum dimensions indicated. These hatches should be located in places easily accessible (not behind the radiator).

#### Minimum dimensions for Manholes and Handholes.

		<b>Handholes</b>	<b>Manholes</b>
<b>Round</b>	<b>Diameter</b>	229	381
<b>Rectangular</b>	<b>Length</b>	368	406
	<b>Width</b>	114	254

The transformer must be designed so that the core-coil assembly cannot move inside the tank.

	<b>GLOBAL STANDARD</b>	Page 53 of 182
	<b>POWER TRANSFORMERS</b> LOCAL SECTION LATAM	<b>GST002</b> Rev. 01 15/01/2014

All procedures related to the welding, including the repairs of the latter, shall follow the instructions indicated in the Standard ASME “Boiler and Pressure Vessel Code”, section IX, or equivalent. The final finishing of the welding will be a smooth surface with a good appearance.

All gaskets must be new, made of synthetic material, compatible with the use of mineral oils, resistant to the effects of moisture and solar rays. The Supplier must supply a complete set of all of the gaskets necessary for the assembly of the transformer. The Distribution Company reserves the right to verify the quality of the gaskets used.

The tanks must include the elements necessary for lifting, carrying, turning, assembly and application of hydraulic jacks.

Clamps should be provided for grounding the tank, welded to it and located at the level of the base on two opposite sides of the tank. These clamps must be suitable for a copper cable with a 70 – 240 mm<sup>2</sup> diameter or a 3 x 40 mm<sup>2</sup> copper bar.

A safety device shall be included on the tank cover, which function is to support two columns to which a lifeline is attached, to be used by personnel in maintenance tasks.

In the case of Edesur, for power transformers with nominal capacity greater or equal to 150 MVA, when expressly requested by the Distribution Company, a “bell-type” tank must be provided.

#### **6.5 INSULATING LIQUID AND MATERIAL**

The oil shall be not contain inhibitors or additives (Class U) according to IEC 60296. The Supplier shall indicate the features oil, its typical composition in percentage indicating the amount of aromatic and naphthenic or isoparaffins components.

The supplier shall include a curve transformer oil level (scale 0 to 10) vs temperature(°C). This curve must be recorder in stainless metal and beside to transformer nameplate.

For Brazil, it is possible to offer local dielectric oil (Class I). However, previously shall be approved by the distribution company.

#### **6.6 MV WIDINGS CONNECTIONS CHANGE**

The transformer must include a panel (in-tank bar connection), or switch equipment off-load (DETC) that allows making or modifying internal connections in the transformer. See Data sheet

In the case of in-tank-bars, all connections must be realized with a minimum decrease in the oil level.

The mechanical joints must ensure perfect and permanent electrical connections that do not loosen with the vibrations. Special tools should not be necessary to make joints.



#### **6.7 COOLING SYSTEM**

The cooling equipment of each transformer shall consist mainly in a group of radiators, and one of two groups of fans normally controlled by a temperature monitor. The number of groups of fans shall depend on the cooling stages specified in Data sheet.

For Brazil (Ampla and Coelce) and Edelnor (Perú) the radiators and fans shall consider a hot dip galvanized as cover layer painting or another scheme previous approved by the distribution company.

##### Radiators:

The radiators must form a structural assembly with the transformer tank, so they must bear the adequate no-load conditions. Pipes should not be used as structural elements for fastening. The

 	GLOBAL STANDARD	Page 54 of 182
	POWER TRANSFORMERS LOCAL SECTION LATAM	GST002 Rev. 01 15/01/2014

location of the radiators must be in accordance with that requested by each company. The radiators must be dismantlable.

The radiators must be sized so that, upon dismantling one of them, the capacity of the cooling system does not affect the transformer's capacity.

The radiators should have bolted flanges at all joints, with throttle valves at the joints with the tank, air purging, drain plugs, and lifting lugs.

Fans:

The fans shall conform one or two independent groups, symmetrical and uniformly distributed, depending on the specific cooling stages.

The fans must have blades made of a single metal piece (not blades bolted). At least must have 3 blades to ensure stability. The fans should have an arrow indicating the direction of the spin and identification of the group to which they belong.

The fan motors shall be three-phase AC power, with the frequency and magnitude indicated:

Rated supply voltage (Vac) Phase-Phase/ Phase-neutral	Coelce (60Hz) – Chilectra and Edesur (50Hz)	380/220
	Edelnor (60Hz)	220
	Ampla (60Hz)	220/127
	Codensa (60 Hz)	208/120

The output cables from each fan motor should be channeled through flexible metal ducts and have watertight plugs, so that they can be removed without cutting off the power, and without compromising personnel safety.

## 6.8 ACCESSORIES AND AUXILIARIES



### 6.8.1 VALVES

The piping system for the cooling oil must have ball type valves, in such a way that it be possible to dismantle any element without it being necessary to empty or lower the level of the transformer's oil.

a. **Valves for the main tank.** Each transformer must be supplied with the following valves :

- Drain valve that allows full drainage. (minimum 2"Ø)
- Filtering valve, near the bottom (minimum 2"Ø).
- Sampling valve for the oil at the bottom (maximum ½"Ø).
- Filtering valve near the top of the tank, on the same side as the storage tank, and on the opposite side as the lower filtering valve. (minimum 2"Ø).
- Sampling valve near the top end of the main tank. (maximum ½"Ø).

For filling the transformer, the Supplier shall put, welded inside the tank, a deflector element that prevents the oil from hitting the windings. The design must keep in mind that it is necessary to prevent the accumulation of gases.

 	GLOBAL STANDARD	Page 55 of 182
	POWER TRANSFORMERS LOCAL SECTION LATAM	GST002 Rev. 01 15/01/2014

b. **Valves for the oil conservator.** Each transformer must be supplied with the following valves:

- Drain valves that allow full drainage. (minimum 1½"Ø).
- Valve at the top for oil fill in (minimum 1½"Ø).
- Sampling valve on the bottom. (maximum ½"Ø).
- Shut-off valves on both sides of the Buchholz relay.
- Vacuum valve, located on the upper part of the oil conservator. (2"Ø minimum).
- Pressure equalization valves between the oil conservator and the on-load tap changer, and for the oil conservator system that the Supplier offers.
- Automatic check valve which will be installed in the Buchholz relay piping connecting the main expansion tank (conservator) and the tank. This valve shall be automatically closed and will block the flow of oil when an important loss occurs in the vat. The operating position shall be clearly identified. In case the check valve is not suitable for realizing treatments or filling with oil through it, a special circuit for said purposes should be provided. A plan with details and constructive profiles of said valve must be provided for its approval, where the check mechanism, the constitutive elements, and the materials employed can be seen.

c. **Valves for the radiators.** Each transformer shall be provided with shut-off valves at the inlet and outlet of each radiator in such a way that repairs or changes can be made without affecting the operation of the transformer.

d. **Conditions required for the valves.** The following conditions must be met by the supplied valves:



- All the drain, filtering, and sampling valves must be able to resist, without leaking, the operating pressures with hot oil and the overpressure tests with air and oil.
- All the filtering valves must be suitable to allow coupling with a flange to the oil treatment equipment.
- Shut off valves must have a device that indicates the closed and open positions and allows their blocking in both positions. Each position must be clearly Marked.
- All valves must be connected by means of flanges, joined with bolts and gaskets that allow installing and removing them individually.
- The radiator valves must be the butterfly type with a metal-metal seal. They must not have "O – rings" for closing.
- Oil-proof blind flanges, or their equivalent must be supplied separately, for use at each joint, when the radiator panels are removed.
- The Supplier shall provide a drawing with location and characteristics of the valves offered.
- For Edesur (Argentina). The upper valves must have intakes at the floor level . The valves will be meeting in a "valves box" located on the side of the oil conservator.

#### 6.8.2 CURRENT TRANSFORMERS (CT's)

When applicable, the CT's bushing type must be included, which must comply with the requirements IEC.

The quantity, location, and type of each current transformer included for metering and protection are indicated in 11.3.

The Supplier shall supply the suitable current transformers to be used with the temperature measurement system and the voltage regulator to control the OLTC. The characteristics of these CT's

 	<b>GLOBAL STANDARD</b>	Page 56 of 182
	<b>POWER TRANSFORMERS</b> LOCAL SECTION LATAM	<b>GST002</b> Rev. 01 15/01/2014

must be informed by the Supplier to the Distribution Company, for its knowledge. The secondary rated current shall be 5 [A] or 1 [A] to confirm.

All secondary CT's terminals must lead to outlet boxes located near the Bushings. These outlet boxes must be hermetic, with protection index IP 54, and be accessible from outside. From these boxes, the Supplier shall wire the CT's secondaries to the transformer's control cabinet.

All the cables ends will have safety terminals. The brand and model of the terminal blocks will be shall be of a well known quality and are subject to the Distribution Company approval.

The polarity of CT's must be subtractive. They must have a minimum thermal factor of 1.2.

The Supplier must provide protocols for the type and routine tests applied to CT's included in the transformer. They must also include the CT's excitation curves.

### **6.8.3 ANCHORING**

For anchoring the transformer to its base, one of the two following alternatives must be considered, as indicated in the point 11. 2:

- a) Skid-type base for direct attachment to the foundation. Chilectra
- b) System with wheels and interlock-brake adequate (seismic forces). Ampla, Coelce, Codensa, Edenor and Edesur.

### **6.8.4 OIL PRESERVATION SYSTEM**

The insulating oil preservation system must be by means of a storage tank. It must include a dehydrating respirator.

A membrane or bag system should be provided to prevent contact of the oil with environmental oxygen.

The storage tank must have an inspection hatch of at least 400 mm diameter, that allows verifying the operation of the level indicator system.

The transformer's storage tank system must have a protection with a double-float Buchholz relay, with two independent contacts for operation. This relay must be earthquake-proof; its installation must be accessible for adjustment and testing tasks; it must be protected so as to prevent its operation due to blows from tools or other external objects. It should be equipped with piping that allows taking gas samples from the relay to an operator standing on the base of the transformer. The relay must be installed with valves on both sides.

The storage tank must be removable and its location must not block the maintenance of other nearby accessories (for example, the OLTC).

For Brazil, oil preservation system must have an membrane/bag rupture relay.

### **6.8.5 No- LOAD TAP CHANGER (DETC).**

In some cases the power transformer must be provided with a No-Load Tap Changer. This changer must also be installed in the transformer's high voltage winding. The information design shall be sent to distribution company to approval.



	GLOBAL STANDARD	Page 57 of 182
	POWER TRANSFORMERS LOCAL SECTION LATAM	GST002 Rev. 01 15/01/2014

As part of the transformer, it must support all the electric and mechanical requirements applied to the latter. The DETC information design shall be sent to distribution company to approval.

It must be provided with an external mechanism for manual operation, to operate at a floor level, which must be simultaneous in the three phases, in the case of three-phase transformers.

It must be installed so that its inspection and maintenance may be realized through an adequately-sized hatch, without being necessary to intervene in the transformer's core or coils.

It must be provided with a visible position indicator that permits its safe inspection and operation for personnel.

It must have an interlocking and safety system that prevents the operation of the switch by external personnel.

The Supplier must include a warning sign that its operation must be without voltage.

#### 6.8.6 PROTECTIONS

The transformer must include at least the following protections:

- An anti-seismic Buchholz relay for the transformer's tank oil preservation system. This relay shall be the double-float type, with three independent contacts, one for alarm due to incipient failure and two operation contacts for frank failure. Mercury contacts shall not be accepted.
- An internal overpressure valve of the transformer and a system for an adequate oil expulsion
- A protection relay for the OLTC.
- A pressure relief valve for the OLTC's tank.

These three last protection elements must have three independent contacts, one for alarm and two for operation.

#### 6.8.7 INSTRUMENTS

The transformer must at least include the following instruments:

a) **Oil level indicators for the transformer and the OLTC**, magnetic type, with two independent NO/NC contacts, or with variable resistance. They shall be adjusted in the factory to operate with a minimum level, which must be expressly indicated by the Supplier. The scale of the level indicators must be graduated from "0" to "10" in a range of 240°, indicating minimum, maximum, and normal levels. The indicators must be installed in their respective storage tanks.

These level indicators must be installed at an inclination angle of 45° to facilitate their reading by an operator standing at the foot of the base.

#### b) **Temperature monitor.**

This instrument, with technology based on microprocessors, must register the instantaneous and maximum oil temperatures and incorporate a simulation circuit to indicate the instantaneous and maximum temperatures of the hottest spot in the transformer's winding (Thermal image).

It must have outlets for remote measurement of oil and windings temperatures. The transformer must include all temperature sensors.

The thermometers placed in the tank must have mechanical protection.

	GLOBAL STANDARD	Page 58 of 182
	POWER TRANSFORMERS LOCAL SECTION LATAM	GST002 Rev. 01 15/01/2014

Optionally, the use of optic sensors will be permitted for the direct measurement of the temperature, as an alternative to the traditional thermal image.

The temperature monitoring system shall be a equipment homologated by the distribution companies (Qualitrol, Tree Tech, SEL, Messko-MR ,etc).

A system should be provided that allows conveniently adjusting the elevation of the hottest spot of the winding above the upper oil, obtained from the heating tests of the transformer.

A display should be included with local information on the oil and windings and ambient temperatures.

It should have the capacity to store data, that allows recovering and reading in the visor the maximum values of oil and windings temperatures.

It should have a class of accuracy of 2%, and an adjustable time constant of between 1 and 10 minutes for the windings temperature.

The algorithm to calculate the hottest spot of the winding must be in accordance with the recommendations of the Standard IEC 60076-7.

The location of the monitor must be suitable so that an operator standing in front of the Control Cabinet can read it without difficulty through a window in the cabinet door.

If requested, it should be supplied with a variable resistance output to power the temperature monitor.

The Supplier must include in the process of the monitor, the software, communications cables, and other accessories.

**c) Parallelism monitoring device.**

This instrument, with microprocessor technology, must collect the respective information for the Companies, this equipment shall be quoted as optional.

**6.8.8 SURGE ARRESTERS SUPPORT**

If surge arresters (not include in supply) are installed above the transformer, the Supplier must supply removable supports, attached to the transformer tank, so that, when installed, they form a rigid assembly with the tank. These supports must be independent from the radiators.

The Distribution Company will indicate in the data sheet if require the surge arresters support.

The surge arresters shall be supplied by the Distribution Company, who shall inform their brand, type, and characteristics to the transformer Supplier.

This information must be used to realize the seismic analysis of the transformer, when applicable.

When applicable, the height of the supports must be adjusted so as the top end of each surge arresters is next to the associated bushing's terminal, thereby complying with the appropriate electric and safety distances



**6.9 MARSHALLING BOX**

In the Control Cabinet, the Supplier shall install the necessary equipment and devices for the feeding and control of the different elements indicated for each company.

The Control Cabinet must be suitable for outdoor use, with a degree of protection IP 54.

It shall be installed at an appropriate height above the base level for a standing operator.

Copyright 2013. All rights reserved.

 	GLOBAL STANDARD	Page 59 of 182
	POWER TRANSFORMERS LOCAL SECTION LATAM	GST002 Rev. 01 15/01/2014

The control circuits and auxiliary equipment must be suitable to be fed from sources of direct or alternating current (DC or AC) provided by the Distribution Company.

Rated supply voltage for control $U_a$ (Vdc)	Ampla, Coelce, Chilectra, Codensa, Edelnor	125
	Edesur	110
Rated supply voltage (Vac) Phase-Phase/ Phase-neutral	Coelce (60Hz) – Chilectra and Edesur (50Hz)	380/220
	Edelnor (60Hz)	220
	Ampla (60Hz)	220/127
	Codensa (60 Hz)	208/120

Both the control circuits, and the power and heating circuits must be protected by thermomagnetic circuit breakers, which, in turn, must have auxiliary alarm contacts.

All the various devices must be wired to terminal strips. When applicable, the Supplier shall realize the wiring in accordance with that indicated in drawings prepared by the Distribution Company.

Once adjudicated the transformer, the distribution company will send to the supplier the drawings and functional requirements of the control circuits. These requirements must be fully compliant in the design of the control circuits

The Control Cabinet must include a lid on the lower part, with bolts, gaskets, and packing nuts, for the inlet and outlet of control and power cables. The cable inlets and outlets may not be on the sides or top of the Control Cabinet.

All the devices must have easy access for their inspection and maintenance.

It must include a lock and a door stop in the open position.

The Control Box inside shall include an electric socket output (Vac).



It must have a shielded heater, controlled by thermostat, to prevent interior moisture condensation. It must also include ventilation louvers with a filter.

It must have interior lighting powered by a door switch.

A device must be provided that allows energizing the heater through the packing, during the equipment's storage period.

The Control Cabinet shall be painted at the same transformer color.

The control drawings will be delivered to the supplier adjudicated. The design of the control circuits shall comply to the information indicated in the control drawings.

 	GLOBAL STANDARD	Page 60 of 182
	POWER TRANSFORMERS LOCAL SECTION LATAM	GST002 Rev. 01 15/01/2014

All devices installed in the Control Cabinet must be conveniently identified by acrylic plates printed indelibly in accordance with the wiring plans. The Control Cabinet itself must also have an identification plate in Spanish or Portuguese, as applicable.

The Control Cabinet shall be installed with dampers or shock absorbers to prevent the transfer of the transformer's vibration to the control elements.

**Control Cabinet's wiring and terminal block**

The insulation of the control cable must be of nominal voltage 0.6/1 kV, as per IEC 60502.

The control cable used for the wiring of the Control Cabinet must have a 90°C class operating temperature. Also, the cable flexibility shall be class 5 as per IEC 60228.

If possible, the different circuits should be differentiated by colors.

The wiring cables of the Control Cabinet must be provided with conveniently identified clampable terminals. The terminals must be the pointed type, with insulating collar.

All the conductors must reach terminal strips or blocks and have indelible markings that indicate: Place of origin / destination. Only one conductor per terminal strip will be accepted.

The terminal blocks shall be the stackable type, suitable for their identification with correlative numbers.

The terminal blocks for current circuits must be sectionable and include bridges that allow short-circuiting them. They must also include type eye terminal.

The Supplier must provide at least 20% of extra terminal blocks, of each type, for the Distribution Company's use.

The channeling inside the cabinets must be implemented preferably using plastic conduit pipes. The conductors shall be grouped and attached with non-metallic fasteners, suitable for protecting its insulation and to support the weight of the cables.



All the external wiring to the control cabinet must be protected against mechanical damage by means of rigid or flexible metal pipes (not accept amendments on the wires). The Cable junction boxes easily accessible

**6.10 PROTECTIVE PAINTING**

Painting cycles for pollution level "High, Very high or Extra Very high", can be proposed by the transformer supplier and approved by Distribution Company.

The paint color is indicated in the Data sheet.

For Brazil, shall be required painting for "extra very heavy" pollution and the cover layer thickness shall be  $\geq 100$  [ $\mu\text{m}$ ] and then the total thickness  $\geq 240$  [ $\mu\text{m}$ ]

 	<b>GLOBAL STANDARD</b>	Page 61 of 182
	<b>POWER TRANSFORMERS</b> LOCAL SECTION LATAM	<b>GST002</b> Rev. 01 15/01/2014

## 7 MAIN COMPONENTS

### 7.1 BUSHINGS GENERAL REQUIREMENTS

The Bushings to allow connecting to aerial conductors. The Bushings must comply with IEC – 60137.

The design of the Bushings must ensure that they can be assembled from outside of the transformer, without raising the tank cover.

The Bushings must be of adequate size so as to allow installing the current transformers in each one of them. The Supplier must present to the Distribution Company the design, to verify the space destined to the current transformers

The external terminals must be made of silver coated copper.

#### 7.1.1 HV BUSHINGS

##### 7.1.1.1 RATINGS

According to the transformer ratings. Data sheets

##### 7.1.1.2 DESIGN REQUIREMENTS

Must be the capacitor type, hermetically sealed, and will have their own independent oil.

The connection from base to the terminal of the Bushings must be continuous. Joints will not be accepted.

They must have an oil level indicator. A person standing at floor level must be able to see the level of oil in the insulator easily.

The Bushings must be provided with a capacitor tap suitable for measurement purposes.

The bases of the bushings must have a plate identifying, indicating each one of the phases.

- Edesur and Edelnor: HV side: 1U-1V-1W-1N
- Ampla –Coelce: : HV side: H1-H2-H3
- Chilectra and Codensa: HV side: H1-H2-H3-N

##### 7.1.1.3 OVERALL DIMENSIONS

The overall dimensions of the bushings shall be in compliance with the relevant standard, if any.

##### 7.1.1.4 TESTS

For the definitions, the prescriptions and the tests procedure IEC 60137 applies, unless otherwise specified.

#### 7.1.2 MV BUSHINGS

##### 7.1.2.1 RATINGS

According to the transformer ratings.

##### 7.1.2.2 DESIGN REQUIREMENTS

Copyright 2013. All rights reserved.

	<b>GLOBAL STANDARD</b>	Page 62 of 182
	<b>POWER TRANSFORMERS</b> LOCAL SECTION LATAM	<b>GST002</b> Rev. 01 15/01/2014

The Medium Voltage Bushings must be the solid type of one single piece of porcelain preferably brown in color or of polymeric material in a grey color.

The bases of the bushings must have a plate identifying, indicating each one of the phases.

- Edesur and Edelnor: MV side:1u-1v-1w-1n
- Ampla –Coelce- Chilectra and Codensa MV side: X1-X2-X3-X0

In case of Edesur, the transformer 80 MVA shall be required two(2) bushings per phase, to conform two(2) outputs MV three-phase (See 11. 5). The bushings will be adequate for power of 40MVA.

### 7.1.2.3 OVERALL DIMENSIONS

The overall dimensions of the bushings shall be in compliance with the relevant standard, if any.

### 7.1.2.4 TESTS

The tests, with regard to the definition, the prescriptions and the test procedure, shall be in compliance with IEC 60137, unless otherwise specified.

## 7.2 ON LOAD TAP CHANGER (OLTC)

The scope of the present chapter is to define the technical-functional parameters, the design requirements and the tests definitions of the on-load tap changers to be used for the voltage regulation.

### 7.2.1 RATINGS

Unless otherwise specified, IEC 60214-1 applies.

The on-load tap changer shall be vacuum type.

The on-load tap changers,with the change-over selector either fine-coarse type or reversing type.

### 7.2.2 DESIGN REQUIREMENTS

The OLTC (on-load tap changer) shall be vacuumm technoly



The OLTC (on-load tap changer) and its accessories must be the brand: Maschinenfabrik Reinhausen (MR) or ABB.

The automatic control equipment must be in accordance with the brand chosen for the OLTC. Other brands of automatic control equipment may possibly be accepted, but are subject to the Distribution Company's approval.

The OLTC and its automatic control equipment, must comply with the Standard IEC 60214-1: "On-load tap changers".

The OLTC's motorized mechanism shall be fed with alternating current (AC) from the Control Cabinet, and must have independent thermo-magnetic protection with auxiliary alarm contact.

Likewise, when requested, the Supplier must provide a device for parallel operation.

 	<b>GLOBAL STANDARD</b>	Page 63 of 182
	<b>POWER TRANSFORMERS</b> LOCAL SECTION LATAM	<b>GST002</b> Rev. 01 15/01/2014

The OLTC must have a lever to operate it manually. When this lever is placed in its operating position there must be a contact that blocks its electrical operation (automatic and manual).

The OLTC must have a local mechanical position indicator which must be visible from the place of operation.

The OLTC must have a mechanical operations counter with at least six(06) digits.

The OLTC must have electric contacts with limit switch and suitable stops that prevent and block the operation beyond its extreme positions.

The OLTC's Control Cabinet must comply with the same construction requirements as the transformer's Control Cabinet.

The OLTC must be easy to maintain. It is not acceptable that other accessories have to be disassembled (for example, the oil storage tank), to be able to realize maintenance to the OLTC selectors.

The Supplier of the transformer must obtain, from the Supplier of the OLTC, the guarantee of good operation of the OLTC for a period equal to or longer than the transformer's guarantee and the detailed maintenance guidelines recommended for the equipment.

The Supplier must provide to the Distribution Company the study realized to adapt the design of the transformer, to the Type of OLTC chosen. In particular it must make known the position of the OLTC in the windings, its location in the center or at the end of the coils, and the use of polarization resistors or any other element of protection against surges, such as voltage arresters.

The Distribution Company may require a a current-compensated voltage regulator relay, for the automatic control of the OLTC. For remote indication of tap positions, the following must be supplied

- One binary-coded decimal (BCD) signal deviced.
- One potentiometric signal deviced.
- One 4 – 20 mA or +/- 10 mA signal deviced

#### **7.2.2.1 PAINTING**



**SEE 6.12**

#### **7.2.2.2 MAINTENANCE**

#### **7.2.2.3 FUNCTIONAL REQUIREMENTS**

#### **7.2.3 TESTS**

According to IEC 60214-1.

 	GLOBAL STANDARD	Page 64 of 182
	POWER TRANSFORMERS LOCAL SECTION LATAM	GST002 Rev. 01 15/01/2014

## 8. TESTS

### Final reception acceptance tests.

The final reception tests at factory of each transformer shall consist in all routine tests

All the tests mentioned are mandatory, unless indicated otherwise and must be included in the price of the transformer.

Further, the Supplier shall quote the following type and special tests. These tests could be made, on each delivery to one unit of same type transformer (not prototype).

- Temperature-rise type test (IEC 60076-2).
- Measurement of zero-sequence impedance(s) on three-phase transformers.
- Measurement of degree of paper polymerization (IEC 60450)

Eventually, Distribution Company could to quote another special or type test.

The Distribution Company may request the verification of the instruments and other equipment that is used in the reception tests, in the presence of its agents. The Supplier must have the certificates of calibration of all the measurement instruments and present them to the inspector when requested.

The sequence of acceptance testing shall be approved previously by the distribution company. For this purpose, the tests schedule shall be sent by the supplier to the distribution company at least two month prior to the tests at the factory by approval

### 8.1 LIST AND CLASSIFICATION OF TESTS

#### 8.1.1 ROUTINE TESTS

#### 8.1.2 ADDITIONAL ROUTINE TESTS FOR TRANSFORMERS WITH $U_m \geq 72,5$ KV

#### 8.1.3 TYPE TESTS

#### 8.1.4 SPECIAL TESTS



#### 8.1.5 GENERAL STATEMENTS FOR THE TESTS

##### 8.1.5.1 SHORT CIRCUIT TEST CRITERIA

In Latam, also is possible to demonstrate the ability to short circuit according Annex A IEC 60076-5 (Theoretical evaluation).

Anyway if expressly required by distribution company may be requested, the performing or repetition of the short circuit test according to the contract conditions.



 	<b>GLOBAL STANDARD</b>	Page 65 of 182
	<b>POWER TRANSFORMERS</b> LOCAL SECTION LATAM	<b>GST002</b> Rev. 01 15/01/2014

## 9 SUPPLY REQUIREMENTS

### 9.1 TRANSPORT

Each transformer and its accessories shall be packed in proper conditions for overland and sea transport, specially preparing the packaging to prevent damage from shock, corrosion, moisture absorption, and theft.

The HV Bushings, radiators, and other dismountable elements must be packed separately from the main body of the transformer, and the contents of each package and its weight must be indicated in detail.

The packing of the delicate accessories must be specially prepared for transport and rough handling and must have clear indications in regard to the fragility of its content.

The marshalling box and other control box, will be mounted in the transformer

Once the transformer is disassembled, each one of the accessories must be identified with the transformer's series N°, for the purpose of facilitating the subsequent assembly work.

Each one of the packages must include facilities for lifting it by straps.

All of the packages must have the necessary identification details and clear and indelible markings for its transport and handling.

Each transformer must be dispatched for transport in vertical position, full of nitrogen gas at a pressure indicated by the Supplier at 25° C or with oil. The alternative (gas or oil) will be agree between Distribution Company and Supplier. The Supplier must install in the transformers an automatic device that allows controlling and maintaining the gas pressure constant during transport.

It must also install an interconnection between the transformer tank and the OLTC tank, to keep the internal pressures equalized during transport.

All elements that may allow gas to escape must be blocked to prevent removals or deliberate openings. The packaging of the tank must have clearly indicated access to control the gas pressure at the port of arrival.

If in the arrival port or on the installation site, it is detected that the gas pressure is insufficient and moisture has entered the equipment, the Supplier must pay the costs involved in the drying process to which it must be submitted.

The transformer must be transported with a three-way impact recorder attached to the tank and adequately protected, which will subsequently be returned to the Supplier.

### 9.2 COMMISSIONING

The site tests on each transformer should be carried out, independently of the tests done in the factory, with the objective of demonstrating the compliance with the specifications once the transformer is fully assembled and prior to its energizing.



The Supplier should consider installation supervision of each supplied transformer.

### 9.3 DOCUMENTATION

The final information "as-built" in digital and paper files. Databook must be inside cabinet block in 03 copies

### 9.4 GUARANTY

Copyright 2013. All rights reserved.

 	<b>GLOBAL STANDARD</b>	Page 66 of 182
	<b>POWER TRANSFORMERS</b> LOCAL SECTION LATAM	<b>GST002</b> Rev. 01 15/01/2014

**9.4.1 DEFECTIVENESS**

**9.4.2 PROTECTIVE COATING**

**9.4.3 TRANSFORMERS IN OPERATION**

**10 EXCEPTIONS**

**11 FIGURES AND TABLES**



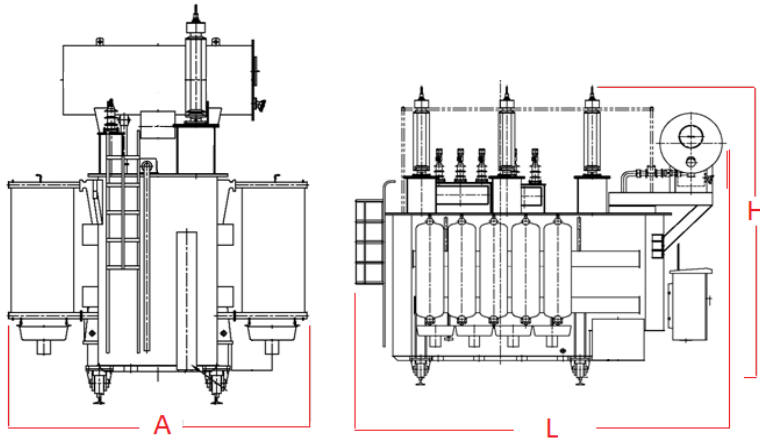

11.1 OVERALL DIMENSIONS



(\*) Only reference figure

Company	HV- Power	Transformer Type : GST002 /...	L [mm]	A [mm]	H[mm]
Chilectra	110kV - 50 MVA	801-802-803-804-805-806-807	< 7100	<5200	<6000
	220kV- 133MVA	809-810	< 8000	<7000	<7000
	220kV- 50 MVA	807-808	< 7500	<5600	<7000
Coelce	7,5 – 15 -33,3 MVA	601-602-603	< 5500	<4800	<4900
Ampla	33,5 MVA	901	< 6250	< 4550	< 5445
	15 MVA	902	< 5700	< 3650	< 5250
	25 MVA	905	< 5350	< 3700	< 4730
	12,5 MVA	906	< 4130	< 3620	< 4310
	41,6 MVA	903	< 5950	< 4410	< 5810
	20 MVA	904	< 5650	< 4500	< 5350
	15 MVA	907	< 4380	< 3340	< 4300
	83 MVA	909	< 7085	<4850	<5960
Codensa	7,5 MVA	908	< 3350	< 2600	< 3390
	40 MVA	701-702	< 6395	< 3894	< 6105
	56 MVA	703	<10614	< 6732	< 10614
	40 MVA	704	< 10514	< 6682	< 9983
	500 kV 150 MVA	705	< 7460	< 7800	< 10975
	230 kV 100 MVA	706	< 7483	< 6157	< 8492
Edelnor	230 kV 56 MVA	707	< 6896	< 5666	< 8112
	200kV - 180 MVA	501	< 7700	< 6700	< 7000
	200/√3kV- 60 MVA	502	< 5490	< 4300	< 7400
	58kV - 40 MVA	503-507	< 4600	< 4000	< 4500
	25 MVA	504-505-506	< 4900	< 4000	< 4500

 	GLOBAL STANDARD	Page 68 of 182
	POWER TRANSFORMERS LOCAL SECTION LATAM	GST002 Rev. 01 15/01/2014

Edesur	40 MVA	401	< 7000	< 4500	< 6300
	80 MVA	402	< 9000	< 4500	< 6500

## 11.2 BASE ANCHORING

- a) Edelnor: Wheel with brake  
Distance between wheels: 1505 mm  
Track Gauge = 1435 mm.

- b) Codensa: Wheel with brake

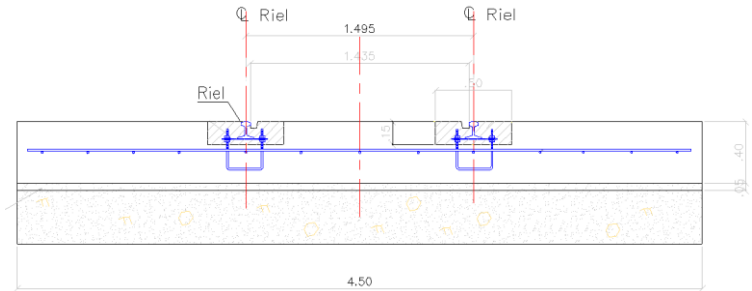
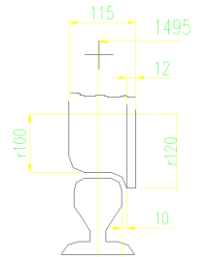

- c) Chilectra: Skid-type

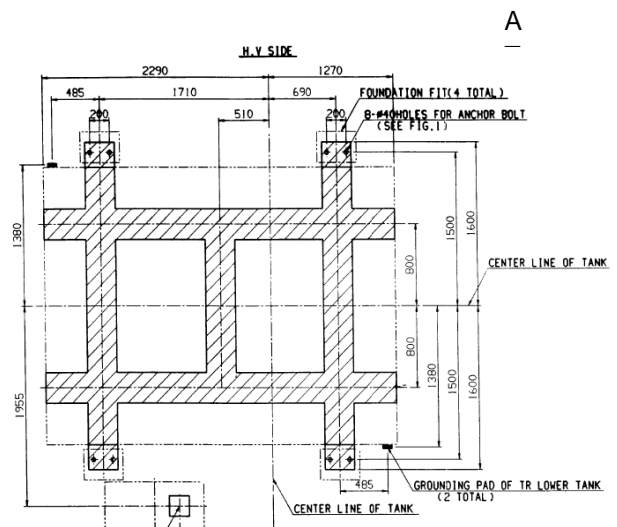
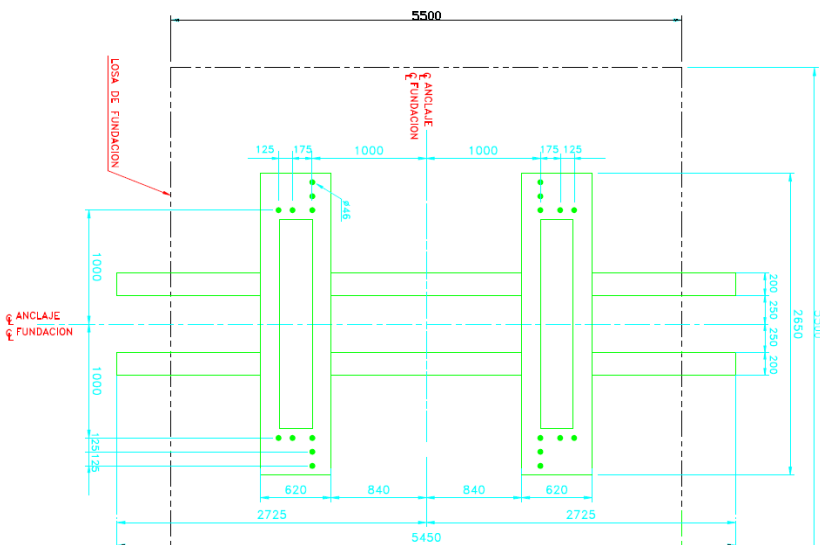

Transformer Three-Phase – 50 MVA

AutoTransformer One-Phase 133MVA

	GLOBAL STANDARD	Page 69 of 182
	POWER TRANSFORMERS LOCAL SECTION LATAM	GST002 Rev. 01 15/01/2014

d) Edesur : Wheel with brake

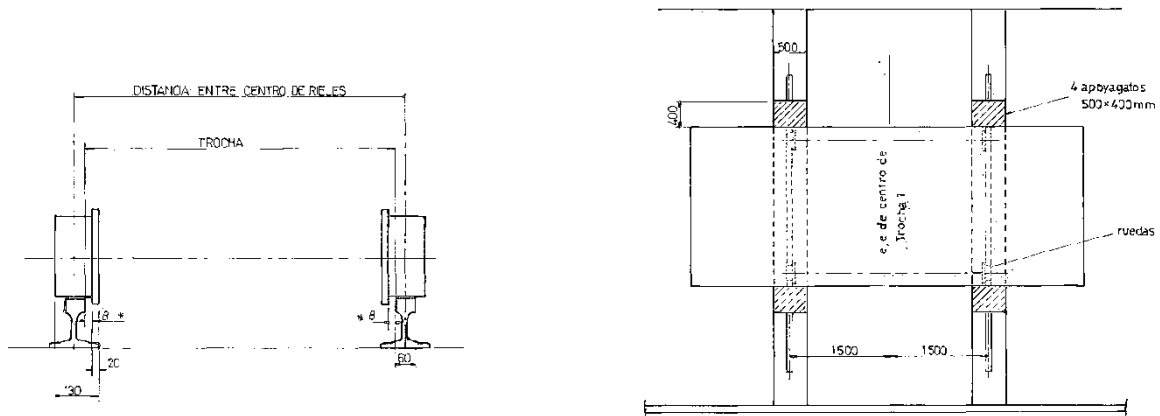

Distance between wheels: 3.000 mm in parallel axis  
1.736 mm on the same axis

Track Gauge: 2.490 mm in parallel axis  
1.676 mm on the same axis



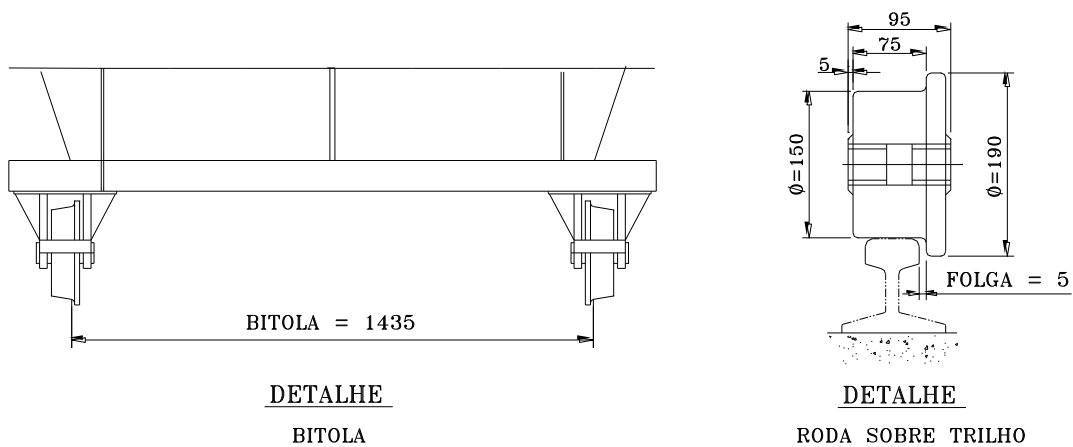

e) Ampla & Coelce: Wheel with brake



 	<b>GLOBAL STANDARD</b>	Page 70 of 182
	<b>POWER TRANSFORMERS</b> <b>LOCAL SECTION</b> <b>LATAM</b>	<b>GST002</b> Rev. 01 15/01/2014

### 11.3 CURRENT TRANSFORMERS IN BUSHINGS.

Company	GST Type	Relation	Quantity	Location	Class	Application	
Ampla	901-2-3-4-8-9	1600/800/400 - 5	3	HV	50VA, 10P20	Protective	
	905-6-7	1400/700/350-5					
	901	2400/1200/600-5	3	MV			
	902-6-8-9	1400/700/350-5					
	903-4-7	1600/800/400-5					
	905	1800/900/450-5					
	909	1600/800/400-5	3	MV2			
	901	2400/1200/600-5	1	Neutral			
	902-6-8	1400/700/350-5					
	903-4-7-9	1600/800/400-5					
905	1800/900/450-5						
909	1600/800/400-5	1	Neutral 2				
Chilectra	801-2-4-5	600/400/200 - 5	3	HV	30VA - 5P20	Protective	
		3000/2000/1000 - 5	3	MV	45VA - 0,2FS5	Metering	
		1200/1000/800 - 5	1	Neutral	30VA - 5P20	Protective	
	803-6	600/400/200 - 5	3	HV	30VA - 5P20	Protective	
		1600/1400/1200 - 5	3	MV	45VA - 0,2FS5	Metering	
		1200/1000/800 - 5	1	Neutral	30VA - 5P20	Protective	
	807-808	300/200/100 - 5	3	HV	30VA - 5P20	Protective	
		1600/1400/1200 - 5	3	MV	45VA - 0,2FS5	Metering	
		1200/1000/800 - 5	1	Neutral	30VA - 5P20	Protective	
	809	1600/1200/1000 - 1		2	HV	30 VA 5P20	Protective
				2	HV	45VA - 0,2FS5	Metering
		3000/2500/2000/1500- 1		2	MV	30 VA 5P20	Protective
				1	MV	45VA - 0,2FS5	Metering
	810	1600/1200/1000 - 1		2	HV	30 VA 5P20	Protective
				2	HV	45VA - 0,2FS5	Metering
3000/2500/2000/1500- 1			2	MV	30 VA 5P20	Protective	
			1	MV	45VA - 0,2FS5	Metering	
Coelce	601	800/600/400/200-5	3	HV	100VA, 10P20	Protective	
			3	MV			
			1	MV-Neutral			
	602	1200/800/600/400-5	3	HV			
			3	MV			
			1	MV-Neutral			
	603	2000/1600/1200/800-5	3	HV			
			3	MV			
		1	MV-Neutral				
Edesur	401	200-1	9	HV	20VA 5P40	Protective	
			3		10 VA, 0,5 FS 5	Metering	
	402	400-1	9	HV	20VA 5P40	Protective	
			3		10 VA, 0,5 FS 5	Metering	
Codensa	705	600/1	1	HV	5 VA - 5P20	Protective	
		600/1	1	HV	10 VA - 0,2S	Metering	
		2500/1	1	MV	5 VA - 5P20	Protective	
		600/1	2	MV2	5 VA - 5P30	Protective	
		600/1	1	Neutral	5 VA - 5P30	Protective	
	706	1000/1	1	HV	20 VA - 5P20	Protective	
		1000/1	1	HV	10 VA - 0,2S	Metering	
		In= 1920 RCT= 1600/1	2	MV	20 VA - 5P20	Protective	
		1200/1	2	MV2	20 VA - 5P20	Protective	
		1000/1	1	Neutral	20 VA - 5P20	Protective	

 	GLOBAL STANDARD	Page 71 of 182
	POWER TRANSFORMERS LOCAL SECTION LATAM	GST002 Rev. 01 15/01/2014

	707	800/1	2	HV	20 VA - 5P20	Protective
		800/1	1	HV	10 VA - 0,2S	Metering
		1200/1	2	MV	20 VA - 5P20	Protective
		1200/1	2	MV2	20 VA - 5P20	Protective
		800/1	1	Neutral	20 VA - 5P20	Protective
Edelnor		Not applie	-			

#### 11.4 PRINCIPAL ACCESSORIES LOCATION

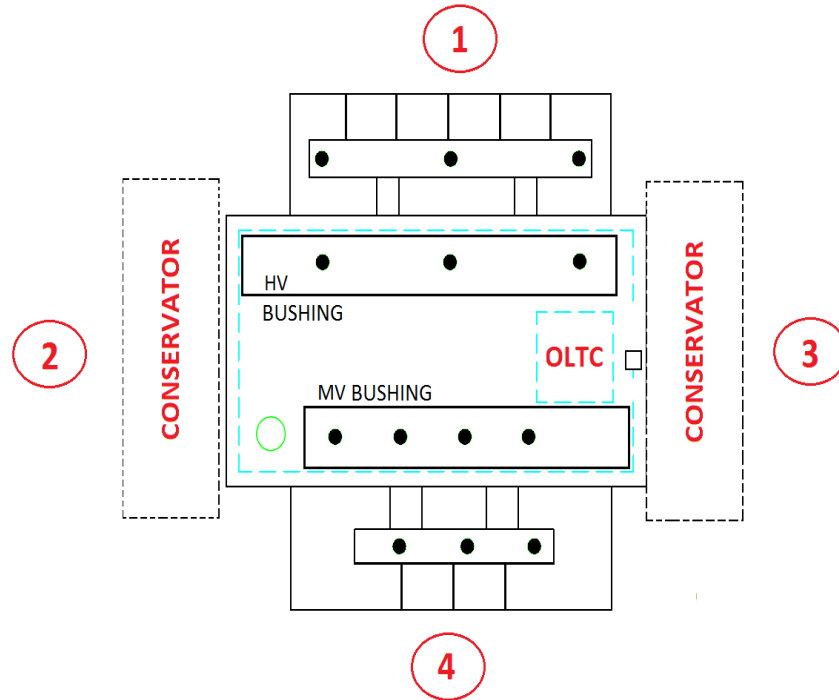

The next **Table** show the principal accessories mandatory location according to the zone or side indicated in the figure previous

	Ampla	Coelce	Codensa	Chilectra	Edelnor	Edesur
Oil Conservator	-	-	Side 2	Side 3	-	Side 2
OLTC	-				-	Side 2
OLTC cabinet	-	-	Side 2	-	-	-
Radiators	-	-	-	Just Side 1	-	-
Control Boxes	-	-	Side 2	Side 4	-	-



	GLOBAL STANDARD	Page 73 of 182
	POWER TRANSFORMERS LOCAL SECTION LATAM	GST002 Rev. 01 15/01/2014

## 11.5 BUSHINGS

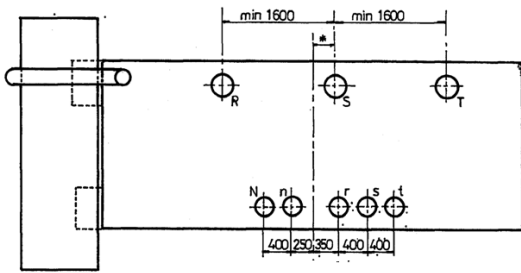

a) Edesur. Bushings HV/MV - Double output MV

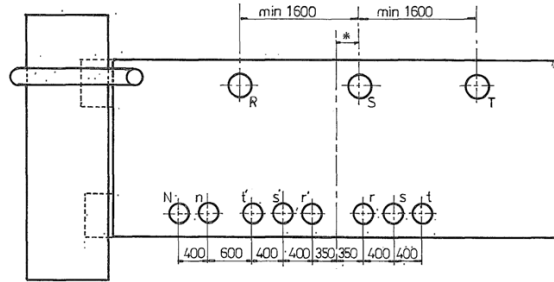

Transformador de 40 MVA





Transformador de 80 MVA

 	GLOBAL STANDARD	Page 74 of 182
	POWER TRANSFORMERS LOCAL SECTION LATAM	GST002 Rev. 01 15/01/2014

**ANNEX B - DATA SHEET FORM**

See file attached



 	GLOBAL STANDARD	Page 75 of 182
	<b>POWER TRANSFORMERS</b> LOCAL SECTION ENDESA DISTRIBUCIÓN ELÉCTRICA (SPAIN)	<b>GST002</b> Rev. 01 15/01/2014

## INDEX – LOCAL SECTION SPAIN

<b>1</b>	<b>SCOPE</b> .....	<b>77</b>
<b>2</b>	<b>LIST OF COMPONENTS</b> .....	<b>77</b>
<b>3</b>	<b>REFERENCE LAWS AND STANDARDS</b> .....	<b>77</b>
<b>3.1</b>	<b>LAWS</b> .....	<b>77</b>
<b>3.2</b>	<b>INTERNATIONAL STANDARDS</b> .....	<b>77</b>
<b>3.3</b>	<b>LOCAL STANDARDS</b> .....	<b>77</b>
<b>3.4</b>	<b>OTHER RELEVANT DOCUMENTS</b> .....	<b>77</b>
<b>3.5</b>	<b>REPLACED STANDARDS</b> .....	<b>78</b>
<b>4</b>	<b>SERVICE CONDITIONS</b> .....	<b>78</b>
<b>5</b>	<b>RATINGS</b> .....	<b>78</b>
<b>5.1</b>	<b>TYPES OF TRANSFORMERS</b> .....	<b>78</b>
<b>5.2</b>	<b>NUMBER OF WINDINGS</b> .....	<b>78</b>
<b>5.3</b>	<b>NUMBER OF PHASES</b> .....	<b>79</b>
<b>5.4</b>	<b>COOLING SYSTEM</b> .....	<b>79</b>
<b>5.5</b>	<b>RATED POWER</b> .....	<b>79</b>
<b>5.6</b>	<b>RATED VOLTAGES</b> .....	<b>79</b>
<b>5.7</b>	<b>RATED FREQUENCY</b> .....	<b>79</b>
<b>5.8</b>	<b>VOLTAGE REGULATION</b> .....	<b>79</b>
5.8.1	HV regulation.....	79
5.8.2	MV regulation.....	79
<b>5.9</b>	<b>WINDINGS CONNECTIONS</b> .....	<b>79</b>
<b>5.10</b>	<b>INSTALLATION</b> .....	<b>79</b>
<b>5.11</b>	<b>HV AND MV NEUTRAL</b> .....	<b>79</b>
<b>5.12</b>	<b>OVER-LOAD CAPABILITY</b> .....	<b>79</b>
<b>5.13</b>	<b>BUSHINGS</b> .....	<b>79</b>
<b>5.14</b>	<b>INSULATION LEVELS</b> .....	<b>79</b>
<b>5.15</b>	<b>LOSSES AND SHORT CIRCUIT IMPEDANCES</b> .....	<b>80</b>
5.15.1	Losses penalties.....	80
5.15.2	Prescribed values of the load losses for the coarse/fine-type HV regulation.....	80
5.15.3	Prescribed value of the load losses for the reversing-type HV regulation.....	80
<b>5.16</b>	<b>OVER-EXCITATION CONDITIONS</b> .....	<b>80</b>
<b>5.17</b>	<b>NO-LOAD CURRENT</b> .....	<b>80</b>
<b>5.18</b>	<b>OVER-TEMPERATURE OF THE CORE</b> .....	<b>80</b>
<b>5.19</b>	<b>CAPABILITY TO WITHSTAND SHORT-CIRCUIT</b> .....	<b>80</b>
<b>5.20</b>	<b>SOUND PRESURE LEVELS</b> .....	<b>80</b>
<b>5.21</b>	<b>OVERALL DIMENSIONS</b> .....	<b>81</b>
<b>5.22</b>	<b>RATING PLATES</b> .....	<b>81</b>
5.22.1	Transformer name plate.....	81
5.22.2	Transformer accessories plates.....	83
<b>5.23</b>	<b>TOLERANCES</b> .....	<b>85</b>
<b>6</b>	<b>DESIGN REQUIREMENTS</b> .....	<b>85</b>
<b>6.1</b>	<b>CORE AND FRAME</b> .....	<b>85</b>
<b>6.2</b>	<b>WINDINGS</b> .....	<b>85</b>
<b>6.3</b>	<b>HV AND MV NEUTRAL</b> .....	<b>87</b>
<b>6.4</b>	<b>TANK</b> .....	<b>87</b>

 	GLOBAL STANDARD	Page 76 of 182
	<b>POWER TRANSFORMERS</b> LOCAL SECTION ENDESA DISTRIBUCIÓN ELÉCTRICA (SPAIN)	<b>GST002</b> Rev. 01 15/01/2014

6.4.1	Frame.....	87
6.4.2	Inspection covers.....	88
6.4.3	Expansion vessels.....	89
<b>6.5</b>	<b>INSULATING LIQUID AND MATERIAL .....</b>	<b>89</b>
<b>6.6</b>	<b>MV WIDINGS CONNECTIONS CHANGE.....</b>	<b>89</b>
<b>6.7</b>	<b>COOLING SYSTEM.....</b>	<b>89</b>
6.7.1	Radiators .....	89
6.7.2	Fans.....	90
<b>6.8</b>	<b>ACCESSORIES AND AUXILIARIES.....</b>	<b>91</b>
<b>6.9</b>	<b>MARSHALING BOX.....</b>	<b>92</b>
6.9.1	Tap-changer control cabinet.....	93
6.9.2	Terminal end and ventilation control cabinet.....	93
<b>6.10</b>	<b>PROTECTIVE PAINTING .....</b>	<b>94</b>
<b>7</b>	<b>MAIN COMPONENTS .....</b>	<b>94</b>
<b>7.1</b>	<b>BUSHINGS GENERAL REQUIREMENTS .....</b>	<b>94</b>
7.1.1	HV bushings .....	94
7.1.2	MV bushings .....	95
<b>7.2</b>	<b>ON LOAD TAP CHANGER .....</b>	<b>96</b>
7.2.1	Rated characteristics .....	96
7.2.2	Design requirements.....	96
7.2.3	Tests .....	96
<b>7.3</b>	<b>OWN PROTECTIONS.....</b>	<b>96</b>
7.3.1	Transformer gas protection.....	96
7.3.2	On-load tap-changer gas protection .....	96
7.3.3	Temperature protection .....	96
7.3.4	Tank overpressure protection .....	97
<b>8</b>	<b>TESTS.....</b>	<b>97</b>
<b>9</b>	<b>SUPPLY REQUIREMENTS .....</b>	<b>97</b>
<b>9.1</b>	<b>TRANSPORT .....</b>	<b>97</b>
<b>9.2</b>	<b>COMMISSIONING.....</b>	<b>97</b>
<b>9.3</b>	<b>DOCUMENTATION.....</b>	<b>97</b>
<b>9.4</b>	<b>GUARANTY .....</b>	<b>98</b>
<b>10</b>	<b>EXCEPTIONS .....</b>	<b>98</b>
<b>11</b>	<b>FIGURES.....</b>	<b>98</b>
<b>11.1</b>	<b>OVERALL DIMENSIONS AND ACCESSORIES.....</b>	<b>99</b>
<b>11.2</b>	<b>SCHEME CENTRALIZATION CABINET.....</b>	<b>102</b>
<b>11.3</b>	<b>OLTC SCHEME.....</b>	<b>104</b>
<b>ANNEX B – SPANISH DATA SHEETS OF TRANSFORMER REQUIREMENTS .....</b>		<b>105</b>

 	<b>GLOBAL STANDARD</b>	Page 77 of 182
	<b>POWER TRANSFORMERS</b> LOCAL SECTION ENDESA DISTRIBUCIÓN ELÉCTRICA (SPAIN)	<b>GST002</b> Rev. 01 15/01/2014

## 1 SCOPE

The scope of this document is to provide technical requirements for the supply of the power transformers to be used in the distribution networks of Endesa Distribución Eléctrica (EE).

## 2 LIST OF COMPONENTS

See Common List.

## 3 REFERENCE LAWS AND STANDARDS

Here below is reported the list of reference laws and standards mentioned in this document.

### 3.1 LAWS

REAL DECRETO 614/2001, de 8 de junio, sobre disposiciones mínimas para la protección de la salud y seguridad de los trabajadores frente al riesgo eléctrico.

Reglamento Sobre Condiciones Técnicas y Garantías De Seguridad en Centrales Eléctricas, Subestaciones y Centros De Transformación.

Council Directive 67/548/EEC on the approximation of the laws, regulations and administrative provisions relating to the classification, packaging and labelling of dangerous substances.

Council Directive 1999/13/EC, of 11 March 1999, on the limitation of emissions of volatile organic compounds due to the use of organic solvents in certain activities and installations.

### 3.2 INTERNATIONAL STANDARDS

EN 50180:2010. Bushings above 1 kV up to 52 kV and from 250 A to 3,15 kA for liquid filled transformers

EN 50216-6:2002. Power transformer and reactor fittings -- Part 6: Cooling equipment - Removable radiators for oil-immersed transformers.

### 3.3 LOCAL STANDARDS

UNE 21428-1:2011. Transformadores trifásicos de distribución sumergidos en aceite, 50 Hz, de 50 kVA a 2 500 kVA con tensión más elevada para el material hasta 36 kV. Parte 1: Requisitos generales. Complemento nacional

UNE 48103:2002. Pinturas y barnices. Colores normalizados.

### 3.4 OTHER RELEVANT DOCUMENTS



NNC00700 Multicore control cables

NMC00100 Cabinet, table and panel wiring.

SFC00300 Transformer protection functional criteria.

SME00900 Procedure for acceptance and start-up tests for power transformers.

SME01100 Procedure for transport, landing, assembly and start-up for three-phase power transformers

 	<b>GLOBAL STANDARD</b>	Page 78 of 182
	<b>POWER TRANSFORMERS</b> LOCAL SECTION ENDESA DISTRIBUCIÓN ELÉCTRICA (SPAIN)	<b>GST002</b> Rev. 01 15/01/2014

### 3.5 REPLACED STANDARDS

SNE022, SNE044 y SNE045.

## 4 SERVICE CONDITIONS

It must be taken into account the following:

During continuous service at the rated frequency and rated power, at any of the taps, for operation with ONAN cooling or ONAF cooling, the allowed heating will be the following

For 40°C ambient temperature:

- Average winding heating 65K
- Upper oil heating: 60K
- Maximum heating of hottest winding point: 78K

In areas with special temperatures (50°C):

- Average winding heating 55K
- Upper oil heating: 50K
- Maximum heating of hottest winding point: 68K

The resulting maximum temperature being (on both cases):

- For the windings 105°C
- For upper oil 100°C
- For the hottest winding point 118°C

For this calculation, that established in IEC 60076-2 will be applicable, and considering the H=1.3 factor to determine the copper-oil gradient for the upper part of the winding based on the average gradient. The Manufacturer must take the measures necessary so that oil heating for the upper layer measured during tests corresponds to the maximum temperature oil existing in the transformer.

## 5 RATINGS

The main common transformers for Endesa Distribución are standardized with common rating as indicate in the following.

### 5.1 TYPES OF TRANSFORMERS

See Common List .

### 5.2 NUMBER OF WINDINGS

See Common List .

 	<b>GLOBAL STANDARD</b>	Page 79 of 182
	<b>POWER TRANSFORMERS</b> LOCAL SECTION ENDESA DISTRIBUCIÓN ELECTRICA (SPAIN)	<b>GST002</b> Rev. 01 15/01/2014

### 5.3 NUMBER OF PHASES

See Common List .

### 5.4 COOLING SYSTEM

See Common List .

### 5.5 RATED POWER

See Common List .

### 5.6 RATED VOLTAGES

See Common List .

### 5.7 RATED FREQUENCY

50 Hz.

### 5.8 VOLTAGE REGULATION

#### 5.8.1 HV regulation

See Common List .

#### 5.8.2 MV regulation

Voltage change and/or voltage regulation and its related changing systems are indicated in Common List and Data Sheets, if required.

Y-D or secondary regulation should be done by bridges under cover. It must be done without opening the transformer.

### 5.9 WINDINGS CONNECTIONS

See Common List .

### 5.10 INSTALLATION

See Common List .

### 5.11 HV AND MV NEUTRAL

See Common List .

### 5.12 OVER-LOAD CAPABILITY



### 5.13 BUSHINGS

The type of bushings is chosen accordingly to the transformer rated power, the rated voltage and the interfaces with the other elements in the substation.

See Common List .

### 5.14 INSULATION LEVELS

Copyright 2013. All rights reserved.

 	GLOBAL STANDARD	Page 80 of 182
	<b>POWER TRANSFORMERS</b> LOCAL SECTION ENDESA DISTRIBUCIÓN ELÉCTRICA (SPAIN)	<b>GST002</b> Rev. 01 15/01/2014

See Common List .

### 5.15 LOSSES AND SHORT CIRCUIT IMPEDANCES

The value indicated for short-circuit voltage, referring to the rated transformer power and in the central position of the on-load tap changer, will be the one indicated in the Common List.

Variation of this short-circuit voltage for any of the other taps should be the minimum possible.

Losses exceeding the prescribed values and/or declared by the Manufacturer will be penalized.

Concerning the penalties for exceeding the required losses, there is a special “free area” where the penalties are not applied, in particular:

- + 0% over the no-load losses specified by the Manufacturer
- + 0% over the load losses specified by the Manufacturer

#### 5.15.1 Losses penalties

#### 5.15.2 Prescribed values of the load losses for the coarse/fine-type HV regulation

In case of coarse-fine type on-load tap changer, the load losses are referred to the condition with the tap changer positioned on the central tap, in such a way that the “rough” regulation is connected while the “fine” regulation is disconnected.

When tap-changer is positioned on the central tap, with the “rough” regulation disconnected while the “fine” regulation is connected, the prescribed value is higher than 5%.

#### 5.15.3 Prescribed value of the load losses for the reversing-type HV regulation

In case of inversion-type on-load tap changer, the load losses are determined with the following equation:

$$P_c = \frac{2 \cdot P_1 + P_2 + P_3}{4}$$

where:

- P1 = load losses measured with the on-load tap changer positioned on the central tap
- P2 = load losses measured with the on-load tap changer positioned on the bottom tap
- P3 = load losses measured with the on-load tap changer positioned on the top tap

### 5.16 OVER-EXCITATION CONDITIONS

### 5.17 NO-LOAD CURRENT



See Data Sheets.

### 5.18 OVER-TEMPERATURE OF THE CORE

### 5.19 CAPABILITY TO WITHSTAND SHORT-CIRCUIT

### 5.20 SOUND PRESURE LEVELS



 	<b>GLOBAL STANDARD</b>	Page 81 of 182
	<b>POWER TRANSFORMERS</b> LOCAL SECTION ENDESA DISTRIBUCIÓN ELECTRICA (SPAIN)	<b>GST002</b> Rev. 01 15/01/2014

<b>Noise Level</b>			
<b>dB(A)</b>			
<b>Rated Power (MVA)</b>	<b>High Voltage</b>		
	<b>Rated Voltage level (kV)</b>		
	<b>≤72,5</b>	<b>110 y 132</b>	<b>≥ 220</b>
<b>16</b>	71	70,5	
<b>25</b>	73	73	76
<b>31,5</b>	74	75	
<b>40</b>	75	77	79
<b>≥ 63</b>		79	81

Table 3

Values considering ONAF (or OFAF) cooling and Sound Pressure.

In case of legal restrictions reduced noise levels are specified in Data Sheets.

## 5.21 OVERALL DIMENSIONS

The dimensions and the position of the main accessories are shown in the Figures enlisted below and reported on chapter 11.1 of this document.

## 5.22 RATING PLATES

All name plates will be made of stainless steel, with a minimum 0.8 mm thickness, indications being engraved or in relief, with a depth no less than 0.2 mm.

All name plates will be in Spanish language.



### 5.22.1 Transformer name plate

The transformers referenced in this standard will bear a name plate, whereon the indications will be easily read by an individual standing at the level of the transformer's running surface.

The values will make reference to the definitive rated power resulting from the extrapolation indicated in section 5.5.

The plate will contain the items indicated as follows:



- Manufacturer Name.
- Three phase/single phase oil-immersed power transformer.
- Transformer type.
- Manufacture number.
- Construction standards: IEC 60076 / GST002
- Manufacture year.
- Insulation level of winding with standard nomenclature.

 	GLOBAL STANDARD	Page 82 of 182
	<b>POWER TRANSFORMERS</b> LOCAL SECTION ENDESA DISTRIBUCIÓN ELÉCTRICA (SPAIN)	<b>GST002</b> Rev. 01 15/01/2014

- Rated power in MVA with ONAF cooling if applicable.
- Rated power in MVA with ONAN cooling.
- Cooling system.
- Rated frequency.
- Rated voltages of HV windings.
- Rated voltages of MV windings.
- Lightning-Impulse Withstand Test Voltages and Power Frequency Withstand Voltage for each winding.
- Average temperature increase in the copper.
- Temperature increase of the hottest winding point.
- Temperature increase in upper oil.
- Short-circuit voltages in central and end positions.
- Vector groups.
- Noise level: sound pressure, in dB (A).
- Oil manufacturer and type.
- Circuits diagrams, with complete drawing of connections in a column allowing for easy interpretation of tap-changer operation, and indication of tap position and of the tap-changer selector wherein the different voltages are obtained.
- Ratio and characteristics of toroidal current transformers installed in the HV terminals for metering and protection.
- Weight to be de-tanked.
- Weight of tank with accessories.
- Oil weight.
- Total transformer weight, full of oil, ready to enter into service.
- Indivisible weight of transformer ready for transportation.

On the plate, there will be a table with columns wherein the following interrelated information will be included:

- Vector diagram of HV winding.
- Tap position (with all tap positions).
- Selector tap position in all tap positions indicated by the tap.
- Pre-selector tap position in all tap positions indicated.
- HV winding voltages in all tap positions, at the rated power.
- Rated currents in all tap positions, at the rated power.
- MV rated voltage.

 	GLOBAL STANDARD	Page 83 of 182
	<b>POWER TRANSFORMERS</b> LOCAL SECTION ENDESA DISTRIBUCIÓN ELÉCTRICA (SPAIN)	<b>GST002</b> Rev. 01 15/01/2014

- MV rated current.
- Vector diagram of MV winding.
- MV terminal marks. Bridges to be made to achieve the vector group and the indication of terminals to which exterior connections should be connected.
- Reference Standard ENEL-ENDESA GST002

Other indications which will be included in Spanish and capital letters:

"TODAS LAS TENSIONES SE ENTIENDEN EN VACIO"

"ESTE TRANSFORMADOR PUEDE SER SOBREEXCITADO EN UN 10%"

"TRANSFORMADOR PREVISTO PARA SOPORTAR EL VACIO ABSOLUTO"

It means:

"ALL VOLTAGES UNDERSTOOD AS NO-LOAD"

"THIS TRANSFORMER MAY BE OVEREXCITED BY 10%"

"TRANSFORMER PREPARED TO WITHSTAND ABSOLUTE VACUUM"

Data included on that plate will be definitively known after the tests.

Since some data included on that plate will be definitively known after the tests, and only for design purposes, manufacturer will provide a provisional drawing of the plate with all the initially supposed data to Endesa Distribución.

### 5.22.2 Transformer accessories plates



To identify transformer fittings, the following name plates will be available:

- On the outside of the tap-changer control cabinet: plate with operator, motor and tap-changer characteristics (current, voltage, value of each transition resistor and their number in parallel).
- Next to the fan set: Easily read plate with characters of approximately 40 mm in height, with the same identification as the corresponding magnetothermals "S2, S3, S4...".
- On the fan set: Name plate including manufacturer, type, voltages, current consumptions, air volume flow and sound level (sound pressure).
- On Buchholz relay: Plate with its characteristics, diameter, oil speed which generates the trigger contact closing, contact data, brand, type and manufacture number.
- The plates mentioned in section 9.7 of this Standard will be placed on the radiator lenti valves.
- A plate will be placed on each one of the fittings (valves, thermometers, etc...) with a text explaining the function it performs or what purpose it has been installed for.
- A plate will be placed close to the thermometer where the adjustment values for ventilation start-up and stop will be indicated, and those corresponding to the alarm and trigger.

These values will be in Spanish:

"Temperatura para arranque y paro de la ventilación 65°C y 55°C (temperatura en descenso)"

"Temperatura para alarma 85°C, Temperatura para disparo 95°C."

 	<b>GLOBAL STANDARD</b>	Page 84 of 182
	<b>POWER TRANSFORMERS</b> LOCAL SECTION <b>ENDESA DISTRIBUCIÓN ELECTRICA (SPAIN)</b>	<b>GST002</b> Rev. 01 15/01/2014

This text means:

Start-up and stop ventilation temperature 65 °C and 55 °C (descent temperature).

Temperature for alarm 85°C, Temperature for trigger 95 °C.

- h)** Close to the inspection cover for core earthing: Plate with a text explaining function.
- i)** Next to the gas collector: Plate, DIN A5 size with diagram of conducts and spigots, identifying each one of the spigots, with a legend with the following indications in Spanish:



<b>OPERACIONES A REALIZAR</b>	<b>ABRIR ESPITAS</b>	<b>ESPITAS CERRADAS</b>
a) Purgado del recipiente	-	-
b) Funcionamiento normal	-	-
c) Recogida de gases	-	-
d) Extracción de la muestra	-	-
e) Las operaciones c) y d) deberán repetirse tantas veces como sea necesario en el caso de que existan gases		
f) Las operaciones de comprobación se efectuarán periódicamente, con una frecuencia no inferior a tres meses, o siempre que se produzca algún tipo de defecto que provoque el disparo del transformador		
NOTA: En funcionamiento normal este equipo deberá estar completamente lleno de aceite.		

It means:

<b>OPERATIONS TO PERFORM</b>	<b>OPEN SPIGOTS</b>	<b>SPIGOTS CLOSED</b>
a) Container purge	-	-
b) Normal operation	-	-
c) Gas collection	-	-
d) Sample extraction	-	-
e) Operations c) and d) should be repeated as many times as necessary if gases exist		
f) Verification operations will be performed periodically, with a frequency no less than 3 months, or whenever some type of defect is produced provoking a transformer trigger		

NOTE: Under normal operation, this equipment should be completely full of oil.

- j)** Next to the silica gel drier: Plate containing an indication similar to the following:
- "Peso aproximado de la carga de silicagel:.....kg."
- "Sustituir el silicagel cuando cambie a ....."
- (It means "Approximate weight of silica gel load:...kg." and "Replace silica gel when it changes to...")
- k)** Two plates with the following indications will be placed adjoining the sides of the expansion vessel, and in such a way that they are legible from the floor, in spanish:
- "Aceite depósito expansión principal."
- "Aceite deposito conmutador."
- (It means Main expansion vessel oil and Tap- changer vessel oil).

 	GLOBAL STANDARD	Page 85 of 182
	<b>POWER TRANSFORMERS</b> LOCAL SECTION ENDESA DISTRIBUCIÓN ELÉCTRICA (SPAIN)	<b>GST002</b> Rev. 01 15/01/2014

- I) On each one of the inspection covers, a plate will be placed indicating what function it has been installed for.

### 5.23 TOLERANCES

See chapter 5.15 of this document.

## 6 DESIGN REQUIREMENTS

The transformer elements will be placed in accordance with chapter 11 of this document.

The transformer design will allow, subject to oil draining and lifting the necessary covers, the inspection and verification of tightening elements. Therefore, Manufacturer has to present detailed documentation on the interior arrangement and organization of the transformer, especially in reference to winding mounting.

Different elements will be interchangeable, in units of identical power constructed by the same Manufacturer. This condition is also applicable to replacement parts.

### 6.1 CORE AND FRAME

The core and yoke tightening elements should be made of steel, and from 145 kV on they should have rounded edges.

The tightening bolts should be made of steel and hold the yokes, not allowing them to pierce the core, regardless of their insulation.

The magnetic circuit should be insulated from its tightening parts by fiberglass insulating material or something similar. Bolts will be insulated with this same material.

For 60 MVA transformers and 145 kV insulation level or lower, cardboard and wood insulations are admitted.

In order to reduce losses, junctions between sheets will be step-lap at 45°, minimizing gaps (<2mm)

#### Core earthing.

The unit formed by the active part of the transformer (core and windings) should rest on the tank, completely insulated from it on its bottom part.



The core will be earthed with a box, provided with an external inspection cover and bushings on the transformer cover, where the core and tightening flanges will be independently connected with copper flat-bar, to one single copper block soldered to the tank cover. They will be screwed in such a way that their manipulation through an inspection cover is possible, to allow their disconnection and the verification of insulation of the core from the mass and tightening flanges.

These connections will have a width greater than 50 mm<sup>2</sup>, and the screws will have an M12 thread or greater.

The location of the inspection cover in relation to the fastening screws will be such that they will be visible so that their safe and correct manipulation is ensured.

### 6.2 WINDINGS

In order to construct the windings with determined characteristics that Endesa Distribución considers very important for machine quality and security, the following will be taken into account.



 	<b>GLOBAL STANDARD</b>	Page 86 of 182
	<b>POWER TRANSFORMERS</b> LOCAL SECTION <b>ENDESA DISTRIBUCIÓN ELECTRICA (SPAIN)</b>	<b>GST002</b> Rev. 01 15/01/2014

The Manufacturer will present a detailed photographic report to show that each and every one of the construction details enumerated in this section has been taken into account.

- Windings will be cylindrical, made of electrolyte copper.
- For rated winding voltages equal or greater than 66 kV, disc windings will be compulsorily used.

<b>Voltages</b>	<b>Minimum radial width (mm)</b>
66 kV and less (in layered windings)	10
110 KV	25
132 KV	38
220 KV	50

- Medium voltage windings will be made with transposed copper insulated with epoxy resin.
- For regulation windings and tertiary, and 52 kV network voltages, helical windings may be used, with or without spacers based on the voltage and cooling.
- Spacers
  - In LV windings without paper insulation, the minimum spacer width will be 2 mm.
  - In windings with paper insulation and voltages equal to or less than 145 kV, minimum spacer width will be 3 mm.
  - In 245 kV windings, minimum spacer width will be 4 mm.
- Strips: guiding strips inside and outside the winding will be used to ensure spacer alignment.
- Minimum insulating paper widths: For mechanical reasons, the minimum number of paper layers should be 3, and the side minimum width should be 0.2 mm for normal conductors and 0.3 mm for CTC. Based on these values, the electric gradient calculated in the service voltage and impulse will determine the necessary width.
- All support blocks and separation cartons used in constructing the windings will be fixed in such a way that their position is maintained, even under hypothetical loosening.
- Separation cardboards between windings will be sufficiently long so that they protrude over themselves, firmly and equally holding all spirals.
- The minimum quantity of disks to reinforce for each head will be 5% of the total winding.
- The settling system for windings over insulating blocks and its support over flanges will be performed in such a way that stress is uniformly distributed throughout the entire development of its heads, even inside the core window. The blocks will be fixed with fastening elements to avoid their loosening.
- Tap connections and winding outlets will be fixed and immobilized to the spirals or disks that they belong to with tethers.

 	<b>GLOBAL STANDARD</b>	Page 87 of 182
	<b>POWER TRANSFORMERS</b> LOCAL SECTION <b>ENDESA DISTRIBUCIÓN ELÉCTRICA (SPAIN)</b>	<b>GST002</b> Rev. 01 15/01/2014

- Supports and insulating supports over which the windings are settled will be wide and robust enough to ensure that deformations will not exist over time.
- And all transpositions and connections between disks, both interior and exterior, will be performed by reinforcing insulation with cardboard of an appropriate width.
- Insulation phase-to-earth clearances may not be reduced with cardboard screens located between the tank and the windings to improve electric phase-to-earth clearances although they are admitted as an added security measure. In exceptional cases, such as in areas with little space to pass cables and elevated insulation levels (voltage  $\geq 220\text{kV}$ ), the cables may be screened with cardboard barriers, ensuring that they are fixed to avoid slipping
- Glues used must be compatible with the hot oil, of polyester or casein type.
- The tether for fixing the cable masses may be done with cotton tape.
- Support material for internal cable connection:
  - For 52kV voltage or lower: The use of stratified wood support structures is admitted.
  - For voltages from 66 kV to 145 kV, both included, the use of stratified wood support structures is admitted whenever there is a 20 mm Presspan (cardboard) width between the conductor insulation and the wood.
  - For voltages higher than 145 kV, only Presspan support structures are admitted, which may also be used in the other voltage ranges.

### 6.3 HV AND MV NEUTRAL

The section of the neutral conductor shall be the same of the phase conductors.

### 6.4 TANK

It must be taken into account the following:

The tank shall be provided with the following parts, located as shown in the figures of the overall dimensions at chapter 11:

- supporting plates on the base for the lay down of the transformer, provided with holed bolts to allow, eventually, the installation of wheels;
- shelf plates on the base for the lifting of the transformer through jacks.



#### 6.4.1 Frame

The transformer, with all of its fittings, expansion vessels included, must constitute a complete and independent unit, mounted on a frame provided with wheels, which can move on rails in two perpendicular directions.

The wheels will be cast steel, with one flange, and can be positioned in two directions at  $90^\circ$ .

To facilitate exchangeability between transformers from different Territory, the frame should allow placing wheels on both directions, transversal and longitudinal, with different distances between rails.

In table 4, the separation distances are indicated for each transformer type between interior head sides for rails, both in a transversal and longitudinal direction.

 	<b>GLOBAL STANDARD</b>	Page 88 of 182
	<b>POWER TRANSFORMERS</b> LOCAL SECTION ENDESA DISTRIBUCIÓN ELÉCTRICA (SPAIN)	<b>GST002</b> Rev. 01 15/01/2014

Transformer	Territory	Track Width (mm)	
		Longitudinal	Transversal
220/MV	CATALONIA	1674	1674, 2435, 3350
132/MV	CANARY	-	-
	CATALONIA	1674	1674, 2435, 3350
	SOUTH ZONE	1674	3106
	BALEARIC	1674	2800
	ARAGON	1435	1435, 2435
110/MV	CANARY	-	-
	CATALONIA	1674	1674, 2435, 3350
	SOUTH ZONE	-	-
	BALEARIC	-	-
	ARAGON	1435	1435, 2435
66/MV	CANARY	1435	1435
	CATALONIA	1674	1674
	SOUTH ZONE	1674	1674
	BALEARIC	1674	1674
	ARAGON	1435	1435

Table 4

A locking device will be placed on two wheels.

The frame will have four support plates for hoisting with jacks, making it possible to change wheel direction. The relative location of these supports will be indicated by the Manufacturer. The wheels will have a fastening system preventing them from falling to the ground when the transformer is raised.

In order to allow the installation of a protection relay for the tank, the transformer must be isolated from the rails by placing insulating plates, between the tank and the wheels. These insulating plates will be fiberglass, 10mm wide at minimum and will protrude 50 mm from the support surface. Their visible part will be painted yellow. The width of the insulating tube of the fastening bolt for the plates will be a minimum of 10 mm.

The test voltage for this insulation will be 10 kV, 50 Hz, during 1 minute. These insulating plates should form part of the supply.

In order to ease gas evacuation from the transformer tank, it should be installed so the cover is inclined between 0.25% and 0.5% in a longitudinal direction, ascending toward the Buchholz relay.



#### 6.4.2 Inspection covers

Transformers with power less than 40 MVA will not have inspection covers.

Transformers with power equal to or greater than 40 MVA will have a practicable vertical window in the tank, with a useful size greater than 50x120 cm, for the possible inspection of the on-load tap-changer selector. To ease this inspection, there will be no screen in this area preventing a direct view of the selector.

For the inspection of connections and tightening systems for transformers whose tank allows so, there will be practicable windows on the upper part of the sides of greater size. These windows will have a useful size of



 	<b>GLOBAL STANDARD</b>	Page 89 of 182
	<b>POWER TRANSFORMERS</b> LOCAL SECTION <b>ENDESA DISTRIBUCIÓN ELÉCTRICA (SPAIN)</b>	<b>GST002</b> Rev. 01 15/01/2014

a minimum of 45 cm. Minimum separation between the surface of the covers and the radiators will be greater than 45 cm.

In order to avoid water filtering through the cover' seal, the lower part of the covers will not be at the same level as the tank cover. They should be located on ridges at least 20 mm high.

The inspection covers will always be fixed with galvanized screws. Fastening with soldered rods and nuts will not be accepted.

### 6.4.3 Expansion vessels

The main expansion vessel and tap-changer vessel will be independent, although the latter may be adjoined to the main one. As such, there will be two silica gel desiccators, two filler plugs and two tubes with their corresponding spherical valve for DN25-type draining, which will be located at man-height. The side walls of the vessel will be removable for easy inspection and cleaning.

There will be oil shut-off ball valve on the tubes connecting each vessel with the tank, to avoid oil draining when the inside of the tank must be manipulated.

In the expansion vessels, there will be: magnetic-type oil level indicator with minimum and maximum level contacts, filler plug, air entry tube through a desiccator and draining tube with a valve, located at man-height. At each side of the conservator, under the magnetic level, there will be horizontal soldered rails to facilitate hooking on a ladder, in such a way that the verification of each magnetic level is possible from it.

## 6.5 INSULATING LIQUID AND MATERIAL

The material's specifications of insulating liquid and material shall be the homologated by Endesa Distribución Eléctrica.

## 6.6 MV WIDINGS CONNECTIONS CHANGE

See chapter 5.8.2 of this document.

## 6.7 COOLING SYSTEM

Radiators should:

- withstand vacuum conditions;
- be painted with the same protective cover of the tank.



It must be ensured the metallic continuity between radiators and the tank.

### 6.7.1 Radiators

Radiators, unless otherwise specified, shall be compliant with the design and tests requirements reported on EN 50216-6:2002.

When the totality of radiators for oil cooling are six or less, they may be installed in one single group, on the HV side. If the number is greater, they will be assembled distributed on the two largest sides of the tank, being able to easily separate them from it.

Suitable non-soldered valves will be provided for the tank in order to be able to remove the radiators without draining the oil from the transformer. The actuating lever for these valves will allow, due to their longitudinal position in relation to the collector, or transversal to it, the logical identification of open or closed.

 	GLOBAL STANDARD	Page 90 of 182
	<b>POWER TRANSFORMERS</b> LOCAL SECTION ENDESA DISTRIBUCIÓN ELÉCTRICA (SPAIN)	<b>GST002</b> Rev. 01 15/01/2014

These valves will bear a clear indication of the “OPEN” and “CLOSED” position. In case that this is not possible due to their construction form, it will be accepted to supply this indication located on plates in a visible place on the upper and lower part of each radiator battery.

Each radiator will have the eyebolts necessary for hoisting them, and will have a drain plug on its lower part, and another air purging one on its upper part.

There will be thermowell sheathes at the inlet and outlet collectors for the two radiators located on the same side of the tank, to measure the temperature during the temperature rise test.

The radiators should withstand the same stresses indicated for the tank.

The metal sheet used will be of the highest quality, and its width, especially in the areas of bends, curves and dints, will be equal or greater than 1 mm.

The exterior surface treatment of the radiators will be in accordance with Commission Directive 1999/13/EC for volatile organic components. Upon studying the cooling surface, it will be taken into account that the transformer will be in masonry cells (normally formed by two side walls) to limit the effects of a possible fire.

The radiators will have the elements necessary to allow, if requested, the installation of an anti-bird protector.

### 6.7.2 Fans

The number of fans and the total volume cooling flow will be defined by the Manufacturer, but in any case, it will never be less than two.

The fan motors will be three-phase, and they should take power indistinctly from 230 or 400 V, 50 Hz, and should be able to correctly operate between voltage limits  $\pm 15\%$  and between frequency limits of 49 and 51 Hz.

The rated voltage value will depend on the place of installation. The definitive supply voltage will be defined when the order is awarded.

The cooling equipment control circuit will be provided to operate in automatic and manual mode, which may be selected with a control (IC) switch located in the transformer cabinet

This selector will have the following positions:

- “Automático”
- “Manual-local”

In manual-local mode, it may be controlled from the transformer cabinet with the selector.

Fan start-up and stop should be controlled by the transformer temperature, with an outdoor thermometer, whose bulb will be situated at the hottest oil point. When the oil reaches a temperature of 65°C, the motor fans will start up automatically and will continue to operate until the oil temperature has lowered to 55°C, at which time they will stop.

The motor fan electrical circuits should be protected with motor protector relays, provided with thermal and electromagnetic protections with signalling contacts, without the fuses overlapping. These elements will be adjusted to a value 1.3 times the real current of the motors.

The fan control equipment will operate at 230 V, 50 Hz, connecting phase-to-phase or between phase and neutral, depending on the power supply voltage of the motor fans, 230V or 400 V.

 	GLOBAL STANDARD	Page 91 of 182
	<b>POWER TRANSFORMERS</b> LOCAL SECTION ENDESA DISTRIBUCIÓN ELÉCTRICA (SPAIN)	<b>GST002</b> Rev. 01 15/01/2014

Fan motors will be protected, at minimum, with an IP2 protection level according to standard EN 60529:1991.

Fans will be consolidated on supports fixed directly on the tank, and as such, will be completely independent of the radiators. In installation for either vertical or horizontal blowing, the blades will have a grill preventing involuntary hand contact.

## 6.8 ACCESSORIES AND AUXILIARIES

Each transformer shall be provided with accessories specified in the following section.

- Sliding rolls and lifting jacks shall not be included, unless it was specified in the order.
- The mechanical and electrical accessories shall be compliant with all parts of EN 50216, unless otherwise specified.
- The screws for the couplings among the different components shall be of stainless steel or galvanized.
- The oil de-hydrating devices shall be cobalt free, accordingly to UE 1999/13/EC.
- The cases of all the devices shall have, unless otherwise specified, IP55 protection degree accordingly to EN 60529:1991.
- Three DN25 shut-off ball valves for extracting oil samples from the upper, bottom and middle part of the tank. They will be located on the front of the tank in an accessible position on the same vertical, grouped in such a way that they are easily identified by their relative position.
- The pipes necessary to this end will be inside the tank and will have the least length possible. These valves will be independent from any other. The valves will end in a flange provided with a blind plug.
- Two DN50 shut-off ball or gate valves for oil filtering, with flanges closed by blind hinges. They will be placed on the smallest sides of the tank in diametrically opposite position. One of them will be placed in such a way that almost complete draining is permitted.
- A DN80 shut-off ball valve located on the pipe joining the Buchholz relay and the main expansion vessel.
- A DN25 shut-off gate valve located on the pipe joining the on-load tap-changer protection relay and the tap-changer oil expansion vessel.
- Four thermowell sheathes, located on the hottest oil area, to house: the thermometer sensor, of the Pt100 winding, and the other two, to provide for future needs, will be provided with a joining plug. The sheathes should fulfill that which is established in standard UNE 21428-1:2011 with a female thread of 1" DIN910 and with an interior length, thread included, of 200 mm. These sheathes will be mounted on a fixed cover which will be screwed to the transformer cover.
- Gas collection equipment. Located in an accessible position, next to the terminals cabinet for transformer electric circuits. It will have a metallic body, for a minimum volume of 500 cc and will be provided with four spigots connected in such a way that it is possible to purge it under any circumstances, regardless whether the Buchholz relay contains gases or not that should be analyzed. All covers, flanges and adaptors that can form areas which may house or retain gas should be connected at their highest part with a tubing system which pipes gas toward the

 	GLOBAL STANDARD	Page 92 of 182
	<b>POWER TRANSFORMERS</b> LOCAL SECTION ENDESA DISTRIBUCIÓN ELÉCTRICA (SPAIN)	<b>GST002</b> Rev. 01 15/01/2014

Buchholz relay. This tubing will not have a gradient less than 4%, and in no case will it be connected at the purge screws of the terminals.

- Screws for tank to earth connection. They will conform to Standard IEC 60076. One of them will be located close to the control cabinet.
- DN25, DN50 and DN80 sized valves should be malleable steel (DIN-1681), bronze, or stainless steel.
- Joints. If using O-rings, they should be gap-free, in such a way that under no circumstances are bonded seals accepted
- The conservator, able to compensate the oil volume variation in the range – 25 °C; + 90 °C. The conservator shall contain an appropriate compartment, to be used for the oil of the on-load tap changer; the oils in the two compartments shall be kept separated. Each of the two compartments shall be provided with:
  - 1a) oil level indicator with the levels – 20 °C, + 20 °C, + 85 °C and electric contacts for the minimum level alarm;
  - 1b) device for oil filling.
  - 1c) device for the oil draining.
  - 1d) window for the inspection.
  - 1e) system for the air breathing (for the de-hydrating devices connection).
  - 1f) two de-hydrating air breathers with hygroscopic substances (auto-regenerating), one for each compartment, mounted at head height (only one with vacuum type OLTC).

#### **Accessories:**

Manufacturer should add those elements they consider necessary:



1. Pt100 oil temperature sensor. The Pt100 probe will be coupled to the thermowell sheath with an intermediate hose fitting for adaptation from 3/4" to 1".

#### **6.9 MARSHALING BOX**

The transformer will have two cabinets: one for actuating the tap-changer and another to control fans and terminals ends.

The common conditions to both cabinets will be:

- They will be protected against dust and water spurts with an IP54X protection level, according to standard EN 60529:1991.
- They will have illumination protected by magneto-thermal protection This illumination will connect when doors open.
- They will have heating with thermostat to avoid condensation, operating at 230V, 50 Hz. A single-phase tap will also be placed for 230 V, 10A, with an earth electrode.
- Each cabinet and its door should be earthed through a flexible copper braid with a minimum cross-section of 60 mm<sup>2</sup>.

 	GLOBAL STANDARD	Page 93 of 182
	<b>POWER TRANSFORMERS</b> LOCAL SECTION ENDESA DISTRIBUCIÓN ELÉCTRICA (SPAIN)	<b>GST002</b> Rev. 01 15/01/2014

- The medium plane height of the cabinets over the ground will be 1.60 m.
- The cabinets will be mounted on rubber pieces or silent blocks, not subjected to lateral forces.
- The two cabinets will be protected, inside and out, with a kind of paint identical to the rest of the transformer.
- The interconnection between cabinets and different transformer fittings will be done with independent multicore cables, fulfilling standard NNC007.  
 They will be mounted by grouping them in one single mass through clamping strips of insulating material, fastening them to elements previously fixed or soldered on the transformer, resistant to the elements.  
 It will not be accepted that the cables go through the inside of channels or tubes, and its route over the transformer cover will be the minimum necessary.
- The maximum resistance temperature will not exceed 50°C

#### 6.9.1 Tap-changer control cabinet

The tap-changer control may be actuated by hand and electrically from the this cabinet.

Electric actuation will be with a three-phase motor, power supplied at 230V, 50 Hz, and must operate correctly between  $\pm 15\%$  voltage limits and 46 and 51 Hz frequency limits. This motor may be star-connected to be powered at 400 V.

The electric circuit will be protected with a motor protector with thermal and electro-magnetic thermal protection, provided with signalling contacts, without the fuses overlapping. Motor protector adjustment will be performed at a value 1.3 times the value of the motor's real current.

It will have an electrical locking system for motor operation, in case of succession of phases of voltage of incorrect power supply.

It will have two contact blocks with their terminals connected to the terminal strip; the first for distance indication of the tap-changer position, and the second for possible use of operation in parallel with another transformer.

It will have a counter of the number of operations performed by the changer, both manually and at a distance.

It will have the possibility to stop the local operation, once it has been initiated.



Permanently maintaining an order does not have to be a reason for the mechanism to go forward or backward more than one step.

#### 6.9.2 Terminal end and ventilation control cabinet

All circuits will be gathered in this cabinet: secondary current transformer ones, air-cooling, tap-changer and own protections. Circuit outlet will be through the bottom part of the cabinet with compression glands so that they are protected from the rain.

Cabinet dimensions will be those indicated in chapter 11.

Inside the cabinet, a binary encoding box will be installed to indicate the tap-changer position from a distance. Supply, assembly and connecting are included, as indicated on figures at chapter 11.

 	<b>GLOBAL STANDARD</b>	Page 94 of 182
	<b>POWER TRANSFORMERS</b> LOCAL SECTION ENDESA DISTRIBUCIÓN ELÉCTRICA (SPAIN)	<b>GST002</b> Rev. 01 15/01/2014

## 6.10 PROTECTIVE PAINTING

The finish colour will be grey, designation S 4502-Y, according to Standard UNE 48103:2002, corresponding to colour RAL 7030.

Once the transformer is situated in its installation place, a paint review will be performed, in order to repair possible imperfections produced during transportation and assembly.

For tank interior paint, paints compatible with hot oil will be used, aliphatic polyurethane or similar.

The internal surfaces of the transformer (including the conservator) shall be protected with the painting withstanding the hot oil (maximal temperature 110°C).

## 7 MAIN COMPONENTS



### 7.1 BUSHINGS GENERAL REQUIREMENTS

The symbols for the bushings are the following:

- for HV: 1U, 1V, 1W; and 1N
- for MV: 2U, 2V, 2W and 2N.
- The terminals to install will be those determined in standards IEC 60137:2008 and EN 50180:2010.
- Insulation distances in the air between points under voltage and between them and the earth will be effective; in other words, it will not be admitted that insulation distances be measured between terminal shafts. They must also comply with standard IEC 60076-3. These distances will be affected by the final altitude of the installation, if it exceeds 1000m in the way indicated in the same standard.
- Tangent of the loss angle ( $\text{tg } \delta$ ) will be less than 0.005.
- The oil drain plug for terminals should be sealed and marked with an indication on an indelible metal plate, fixed to the terminal.
- HV bushings corresponding to phases and neutral for  $\geq 123$  kV voltages will be supplied with a capacitive tap provided with its corresponding protective plug. Additionally, the suitable connector will be included in the supply for the test connection to said capacitive tap.
- HV bushings must allow current transformer assembly for machines with  $\geq 40$  MVA power, wherein a thermal image should be installed in the winding with the greatest gradient.
- The terminal and other external connection elements forming part of the HV terminal will be copper, silver or tin-plated.
- Bushings up to 52 kV will be "plug-in terminal" type, PFISTERER or similar, instead of porcelain terminals.

#### 7.1.1 HV bushings

##### 7.1.1.1 Ratings

 	GLOBAL STANDARD	Page 95 of 182
	<b>POWER TRANSFORMERS</b> LOCAL SECTION ENDESA DISTRIBUCIÓN ELÉCTRICA (SPAIN)	<b>GST002</b> Rev. 01 15/01/2014

See Data Sheet

The terminals to install will be those determined in standards IEC 60137:2008 and EN 50180:2010.

HV terminals will have a creepage distance of 25 mm/kV or 31 mm/kV, as indicated on Data Sheets.

#### 7.1.1.2 Design requirements

Insulation distances in the air between points under voltage and between them and the earth will be effective; in other words, it will not be admitted that insulation distances be measured between terminal shafts. They must also comply with standard IEC 60076-3. These distances will be affected by the final altitude of the installation, if it exceeds 1000m in the way indicated in the same standard.

Terminal loss tangent ( $\text{tg } \delta$ ) will be less than 0.005.

The oil drain plug for terminals should be sealed and marked with an indication on an indelible metal plate, fixed to the terminal.

HV terminals corresponding to phases and neutral for  $\geq 123$  kV voltages will be supplied with a capacitive tap provided with its corresponding protective plug. Additionally, the suitable connector will be included in the supply for the test connection to said capacitive tap.

HV penetrating terminals must allow current transformer assembly for machines with  $\geq 40$  MVA power, wherein a thermal image should be installed in the winding with the greatest gradient.

The terminal and other external connection elements forming part of the HV terminal will be copper, silver or tin-plated.

Terminals up to 52 kV will be "plug-in terminal" type, PFISTERER or similar, instead of porcelain terminals.

#### 7.1.1.3 Overall dimensions

#### 7.1.1.4 Tests

### 7.1.2 MV bushings

#### 7.1.2.1 Ratings

The bushings shall be compliant with EN 50180:2010.

#### 7.1.2.2 Design requirements

The bushing shall be manufactured in compliance with EN 50180:2010 and IEC 60137:2008.

The flanges shall be preferably in aluminium, stainless steel, or hot dip galvanized steel in compliance with IEC 60076.

The screws and the other small parts shall be made by stainless material.



The terminal to connect the external MV conductors shall be disassemble from outside.

It is allowed a maximum inclination of  $30^\circ$  with respect to the vertical.

Terminals up to 52 kV will be "plug-in terminal" type, PFISTERER or similar, instead of porcelain terminals; except neutral and compensation tertiary, where porcelain terminals will be installed.

#### 7.1.2.3 Overall dimensions

#### 7.1.2.4 Tests

 	<b>GLOBAL STANDARD</b>	Page 96 of 182
	<b>POWER TRANSFORMERS</b> LOCAL SECTION ENDESA DISTRIBUCIÓN ELECTRICA (SPAIN)	<b>GST002</b> Rev. 01 15/01/2014

## 7.2 ON LOAD TAP CHANGER

### 7.2.1 Rated characteristics

The on load tap changer shall be vacuum type.

See Data Sheets.

### 7.2.2 Design requirements

#### 7.2.2.1 Painting

#### 7.2.2.2 Maintenance

#### 7.2.2.3 Functional requirements

### 7.2.3 Tests

## 7.3 OWN PROTECTIONS

The Transformer will have the following own protections, as indicated in document SFC003 "Functional criteria for HV/MV transformer protections".

### 7.3.1 Transformer gas protection

Buchholz relay. It will have two floats, each one of them provided with magnetic contacts, normally open, which will close upon noting the anomaly.

This relay will communicate with the gas collection equipment with two interior  $\varnothing$  5 mm copper tube conductors, one connected to its upper part for gas collection, and the other on the lower part of the relay, whose mission is to allow filling oil, and consequently, purging the gas collection tank.

The Buchholz relay location will be such that its verification will be possible both from the transformer cover by an individual standing on it and from a ladder which, from the floor, rests on the actual tubing, encased in it or in rails soldered to the tubing.

To facilitate Buchholz relay replacement, there will be spherical valves on both sides allowing its dismounting without removing the oil.

### 7.3.2 On-load tap-changer gas protection

On-load tap-changer protective relay, of rapid oil circulation type.

### 7.3.3 Temperature protection

A thermometer and a thermal image will be installed (if  $P \geq 40$  MVA), with quadrant indicators with anti-vibration support, with four contacts for each one of them, two for oil temperature control on its hottest part, and another two for ventilation start-up and stop, adjustable between 40 and 120 °C.

Temperature	Fan Start-up	Fan Stop	Alarm	Trigger
Oil (thermometer)	65°C	55°C	85°C	95°C
Winding (thermal image)	(-)	(-)	95°C	110°C



 	<b>GLOBAL STANDARD</b>	Page 97 of 182
	<b>POWER TRANSFORMERS</b> LOCAL SECTION ENDESA DISTRIBUCIÓN ELÉCTRICA (SPAIN)	<b>GST002</b> Rev. 01 15/01/2014

Each one of the measurements will be identified with a name plate

Thermometer situation respect to the floor will be 1.6 m.

Transformers without a thermal image ( $P < 40\text{MVA}$ ) will replace it with a thermostat/thermometer.

#### **7.3.4 Tank overpressure protection**

A spring-type security device against overpressures located on the very cover of the tank, constituted by a spring valve of 12.5 cm of minimum useful diameter, provided with a flip-flop alarm and visual indication of its actuation. The flip-flop condition of the micro-contact will be independent of any other external mechanical retention. The box for housing the micro-contact should be protected from rain and have the corresponding aeration orifice to avoid condensation. A cylindrical tube of little height should be placed inside the tank, and as a skirt protection, soldered to the lower part of the transformer cover, to prevent the passage and housing of gases to the valve body.

The number of overpressure devices to install in the transformers will be based on the quantity of oil and manufacturer relief valve specifications.

## **8 TESTS**

## **9 SUPPLY REQUIREMENTS**

### **9.1 TRANSPORT**

The transportation, unloading, assembling and placing in its definitive place, as well as transformer tests before commissioning it will be performed by the Manufacturer, without any help from Endesa Distribución, nor staff nor materials nor equipment.

The transformer and the totality of its accessories, including oil, will be transported with the official permits established by the corresponding authorities, being the sole responsibility of the Manufacturer.

The covers and flanges utilized for transportation must stay in the installation, at the disposal of Endesa Distribución, conveniently fixed with screws underneath the tank.



### **9.2 COMMISSIONING**

In documents SME011 "Procedure for the transportation, unloading, assembly and commissioning of HV/HV/MV three-phase power transformers" and SME009 "Procedure for commissioning Power Transformers", the work and verifications are indicated which, at minimum, the Manufacturer should perform during assembly and commissioning the transformer.

This document, along with the work programme, list of accessories, oil treatment monitoring, test protocols, etc., will form part of the documentation the Manufacturer will deliver to Endesa Distribución once assembly is finished and before starting up the transformer.

Provisional Acceptance will be performed on-site after the transformer is commissioned.

### **9.3 DOCUMENTATION**

 	<p style="text-align: center;">GLOBAL STANDARD</p>	<p style="text-align: right;">Page 98 of 182</p>
	<p style="text-align: center;">POWER TRANSFORMERS LOCAL SECTION ENDESA DISTRIBUCIÓN ELECTRICA (SPAIN)</p>	<p style="text-align: right;">GST002 Rev. 01 15/01/2014</p>

#### 9.4 GUARANTY

#### 10 EXCEPTIONS

In case there was any exception to this specification, manufacturer must indicate them clearly enough at the Data Sheet.

#### 11 FIGURES

11.1 OVERALL DIMENSIONS AND ACCESSORIES

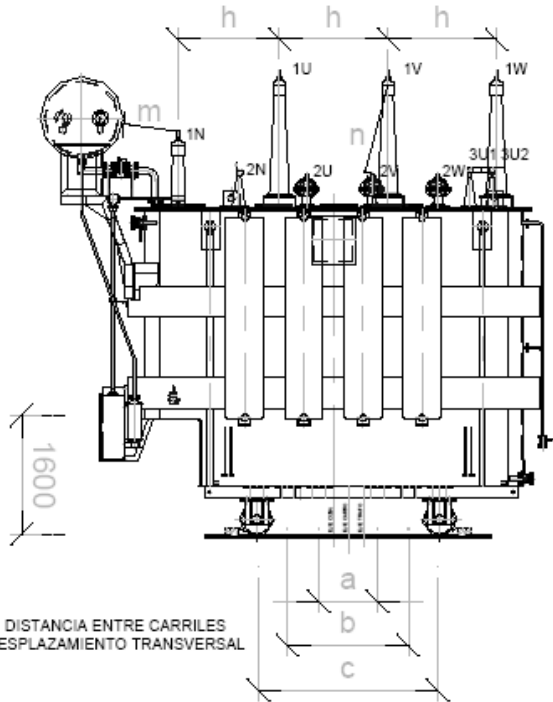

DISTANCIA ENTRE CARRILES  
 DESPLAZAMIENTO TRANSVERSAL

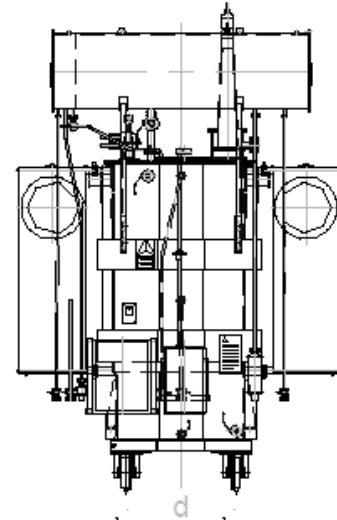

DISTANCIA ENTRE CARRILES  
 DESPLAZAMIENTO LONGITUDINAL

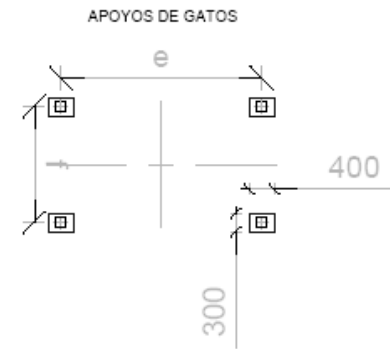
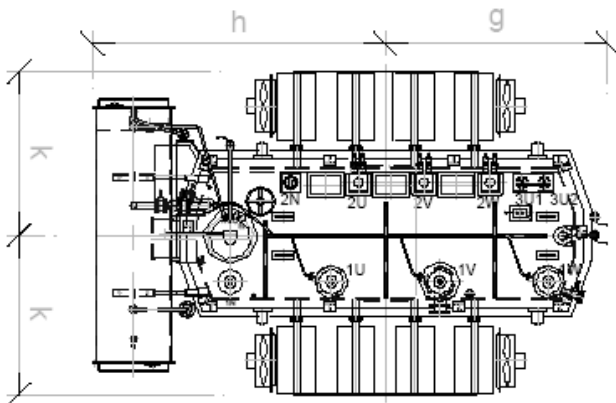

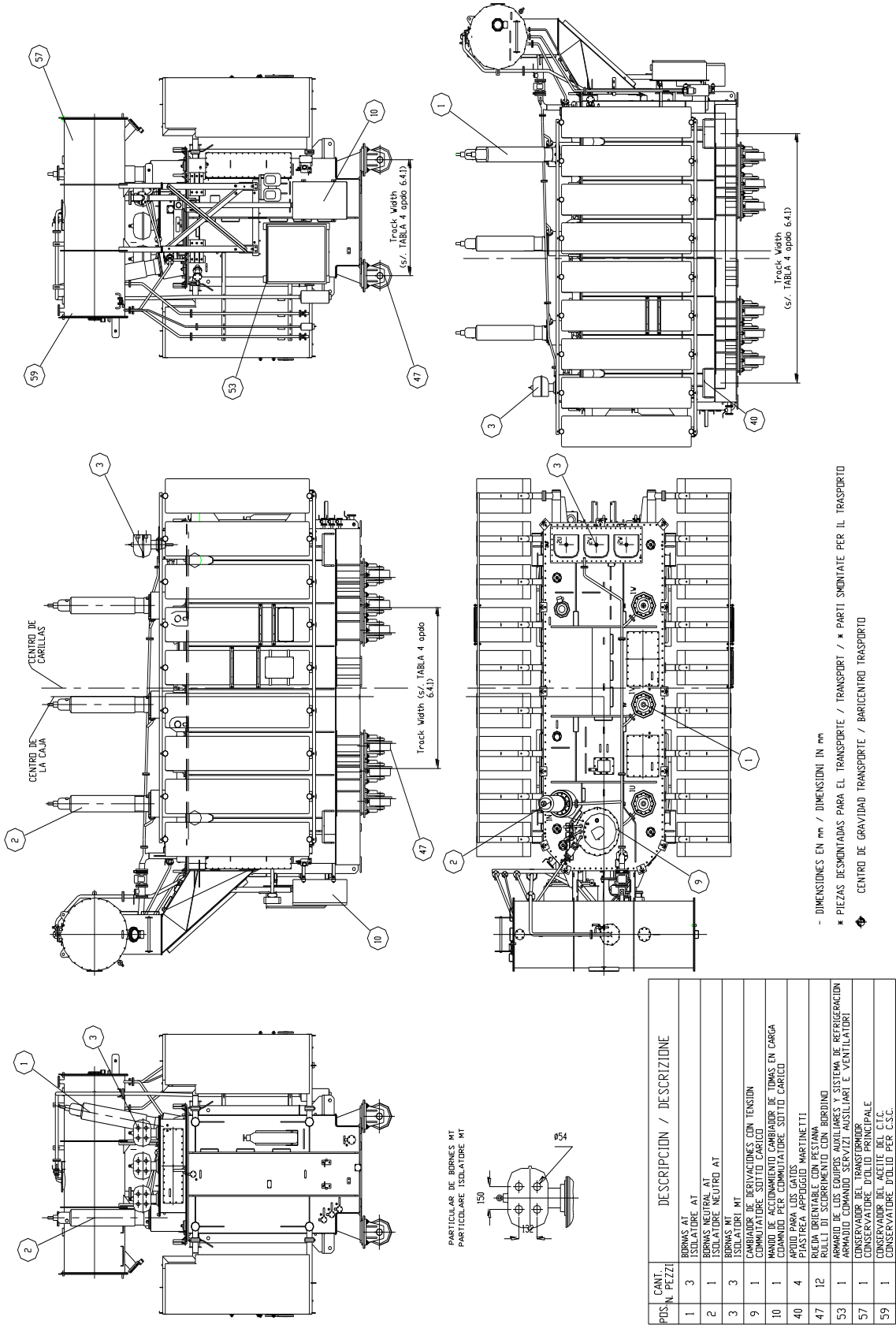

- DIMENSIONES EN mm / DIMENSIONI IN mm  
 \* PIEZAS DESMONTADAS PARA EL TRANSPORTE / TRANSPORT / \* PARTI SMONTATE PER IL TRASPORTO  
 ◆ CENTRO DE GRAVIDAD TRANSPORTE / BARICENTRO TRASPORTO

POS. N. PEZZI	CANT.	DESCRIPCION / DESCRIZIONE
1	3	BORMAS AT / ISOLATDRE AT
2	1	BORMAS NEUTRAL AT / ISOLATDRE NEUTRO AT
3	3	BORMAS NEUTRAL MT / ISOLATDRE MT
9	1	CAMBIAOR DE DERIVACIONES CON TENSION / COMUTATDRE SOTTO CARICO
10	1	MANDO DE ACCIONAMIENTO CAMBIAOR DE TOMAS EN CARGA / COMANDD PER COMUTATDRE SOTTO CARICO
40	4	APDIO PARA LOS GATOS / PASI PER I GATDRI
47	12	RUJLLI DI SGORRIMENTO CON BORDINDO / RULLI DI SGORRIMENTO CON BORDINDO
53	1	ARMADIO DE LOS EQUIPOS AUXILIARES Y SISTEMA DE REFRIGERACION / ARMADID COMANDD SERVIZI AUSILIARI E VENTILATDRI
57	1	CONSERVADORE DEL ACEITE DEL C.T.C. / CONSERVATDRE D'OLIO PRINCIPALE
59	1	CONSERVADORE D'OLIO PER C.S.C.

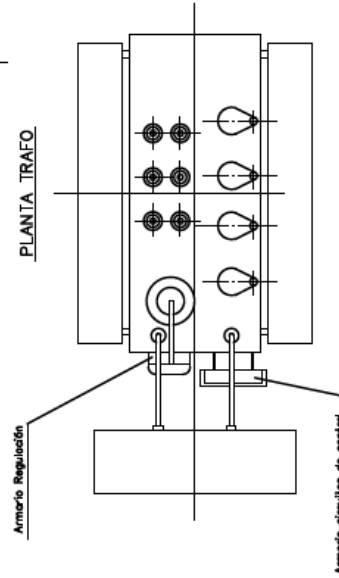
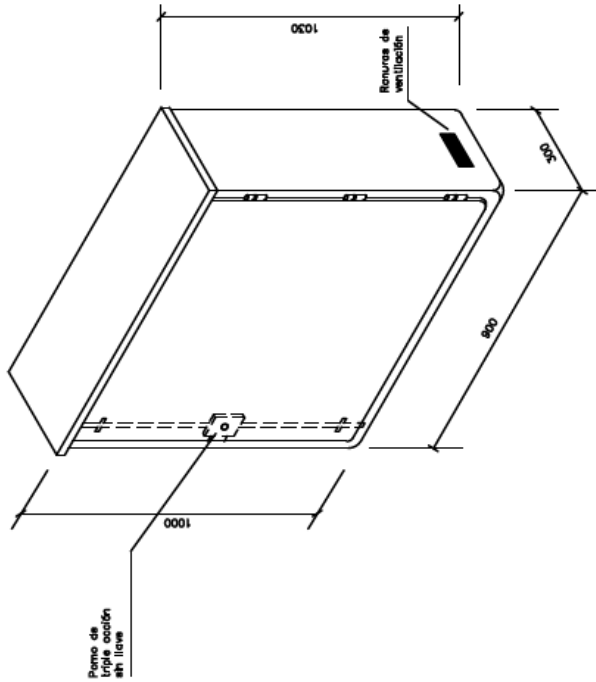

CAJA FINAL DE BORNES TRANSFORMADOR  
 DISPOSICION APARATOS

TR-01.DWG

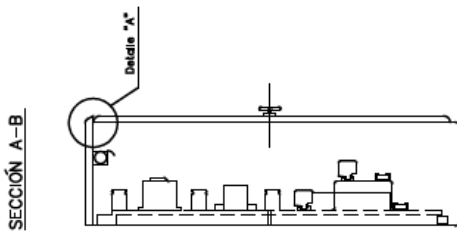

DETALLE "A"  
 Escala 1:1

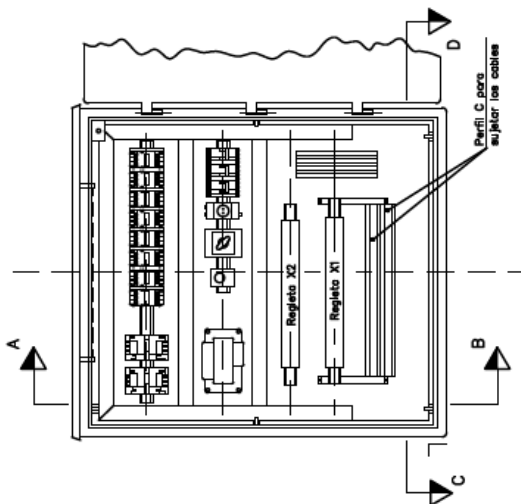
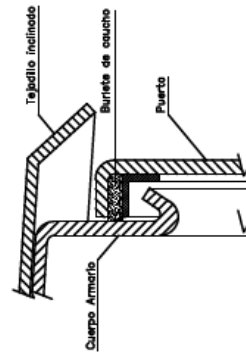

SECCIÓN C-D

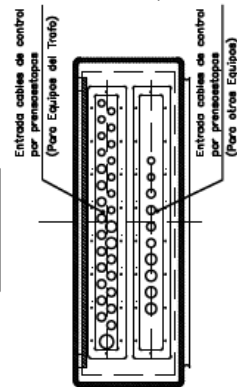

11.2 SCHEME CENTRALIZATION CABINET

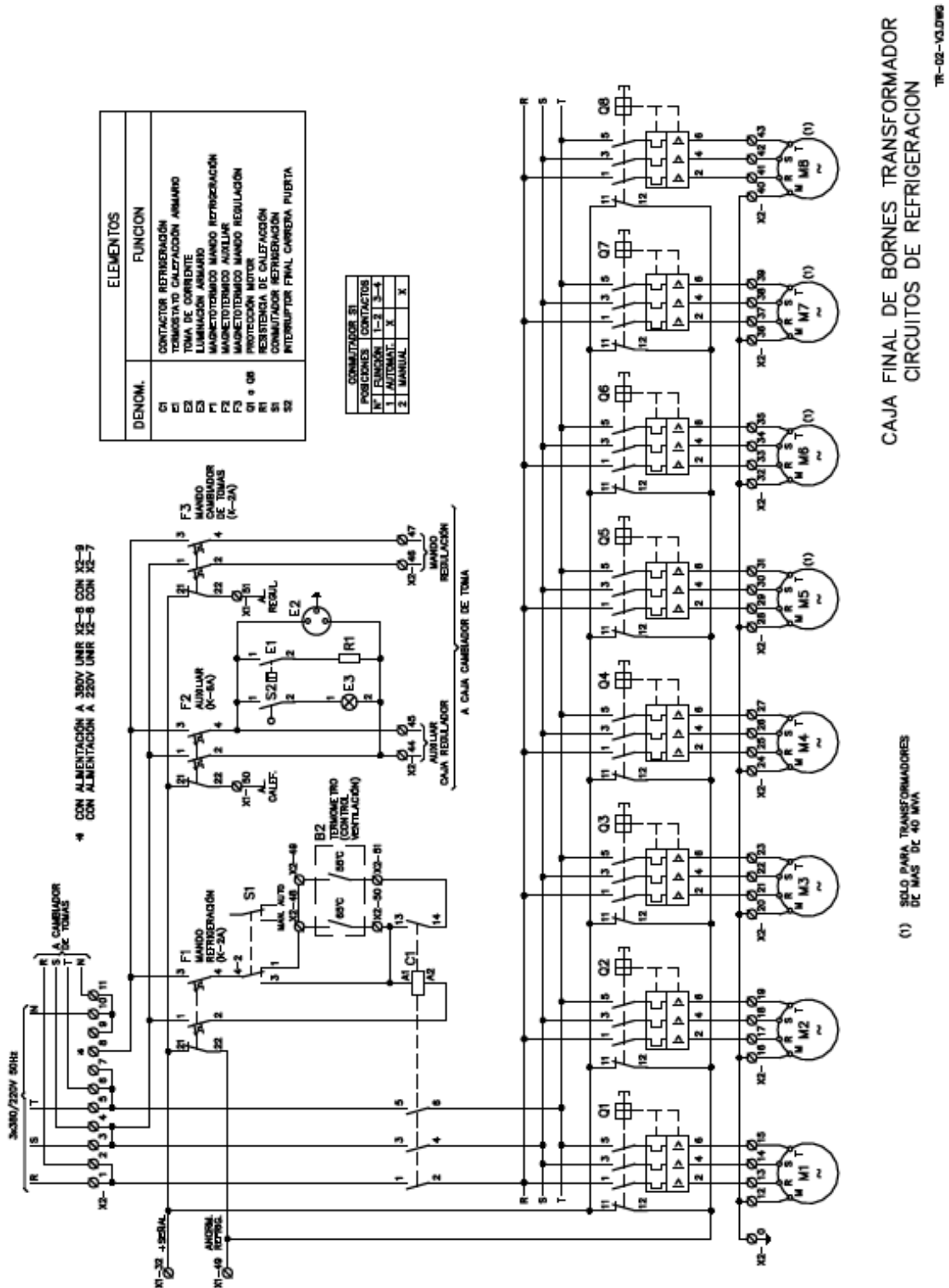



POWER TRANSFORMERS
LOCAL SECTION
ENDESA DISTRIBUCIÓN ELECTRICA (SPAIN)

GST002
Rev. 01
15/01/2014

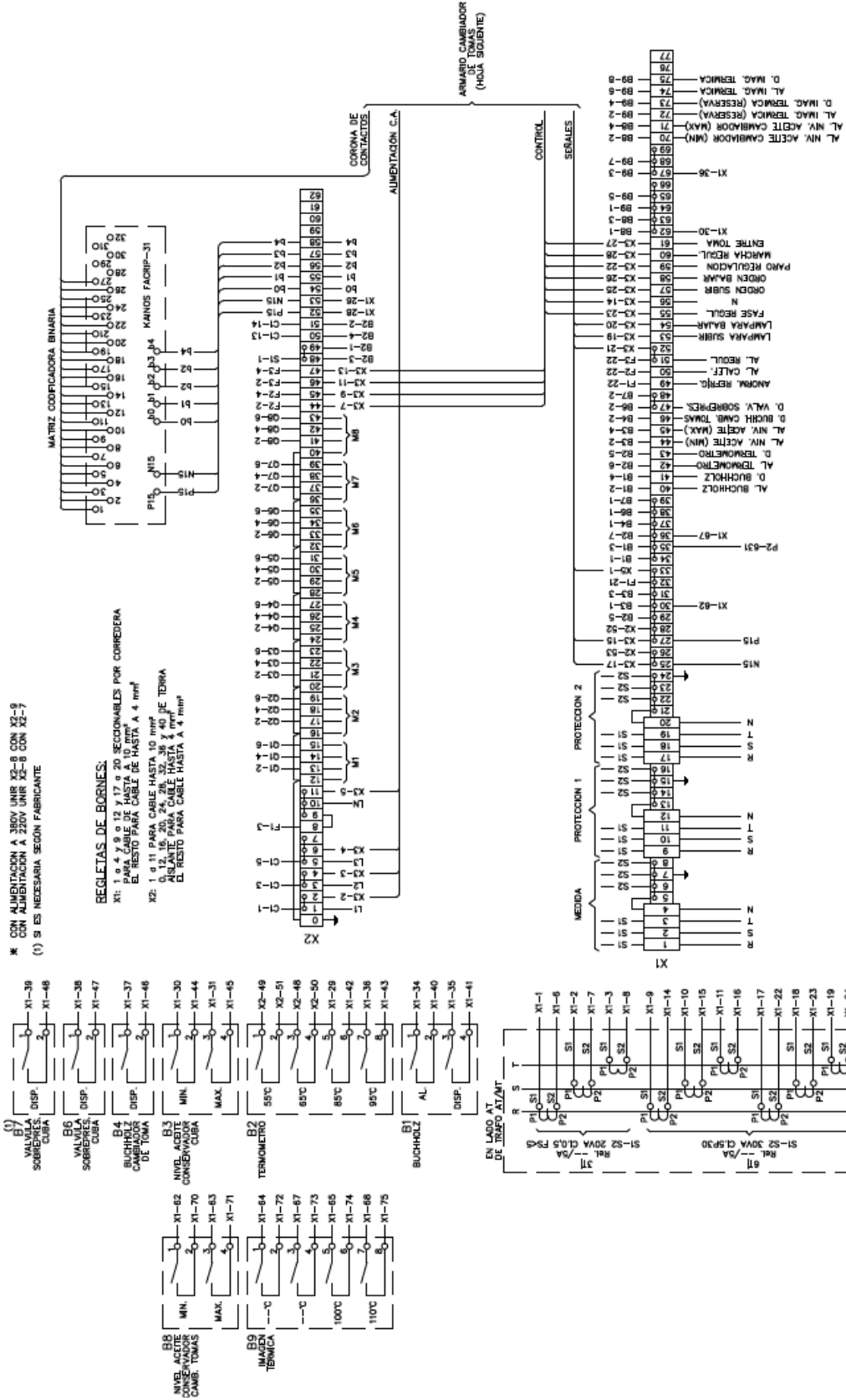

CAJA FINAL DE BORNES TRANSFORMADOR
CIRCUITOS DE REFRIGERACION, PROTECCIÓN
E INDICACIÓN TOMAS CAMBIADOR



TR-03-05-DWG

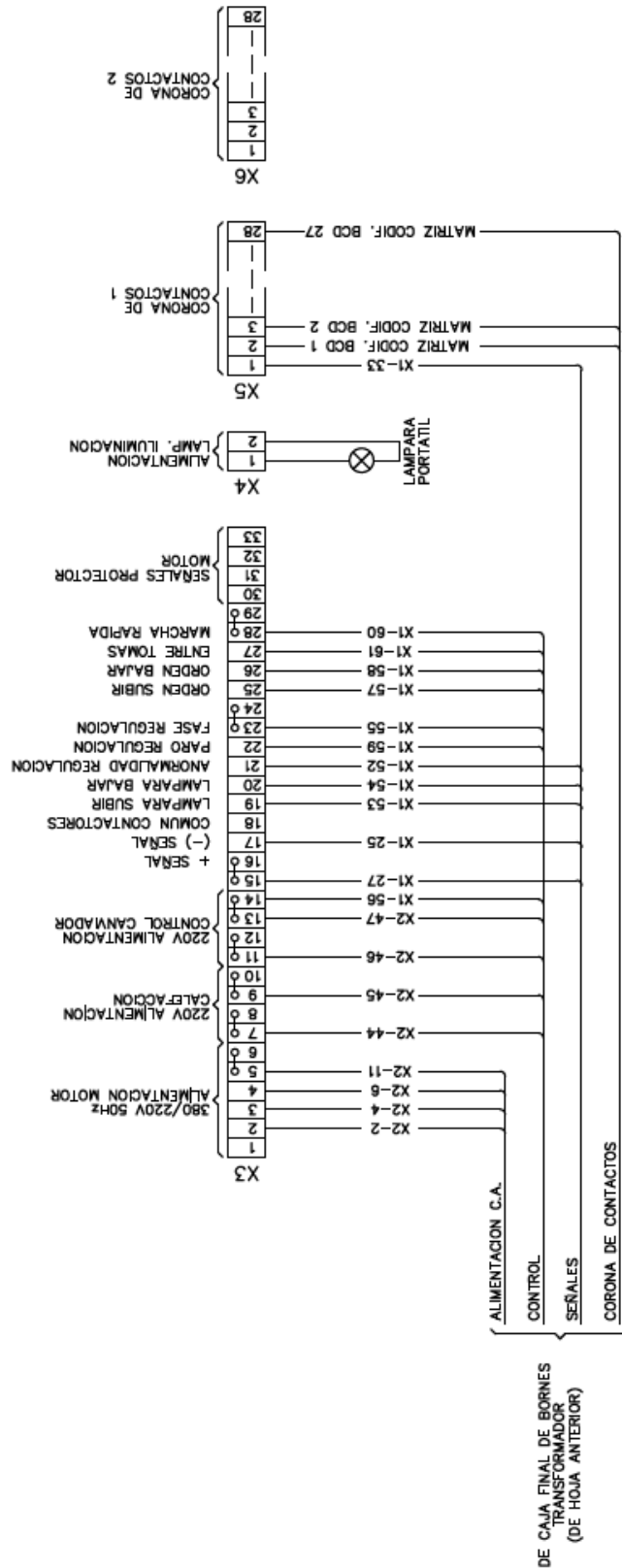

11.3 OLTC SCHEME







 	<b>GLOBAL STANDARD</b>	Page 105 of 182
	<b>POWER TRANSFORMERS</b> LOCAL SECTION ENDESA DISTRIBUCIÓN ELECTRICA (SPAIN)	<b>GST002</b> Rev. 01 15/01/2014



**ANNEX B – SPANISH DATA SHEETS OF TRANSFORMER REQUIREMENTS**

See file attached



 	GLOBAL STANDARD	Page 106 of 182
	<b>POWER TRANSFORMERS</b> LOCAL SECTION ENEL DISTRIBUTIE (ROMANIA)	<b>GST002</b> Rev. 01 15/01/2014

## INDEX – LOCAL SECTION ROMANIA



<b>1</b>	<b>SCOPE</b> .....	<b>109</b>
<b>2</b>	<b>LIST OF COMPONENTS</b> .....	<b>109</b>
<b>3</b>	<b>REFERENCE LAWS AND STANDARDS</b> .....	<b>109</b>
<b>3.1</b>	<b>LAWS</b> .....	<b>109</b>
<b>3.2</b>	<b>INTERNATIONAL STANDARDS</b> .....	<b>109</b>
<b>3.3</b>	<b>LOCAL STANDARDS</b> .....	<b>109</b>
<b>3.4</b>	<b>OTHER RELEVANT DOCUMENTS</b> .....	<b>110</b>
<b>3.5</b>	<b>REPLACED STANDARDS</b> .....	<b>110</b>
<b>4</b>	<b>SERVICE CONDITIONS</b> .....	<b>111</b>
<b>5</b>	<b>RATINGS</b> .....	<b>111</b>
<b>5.1</b>	<b>TYPES OF TRANSFORMERS</b> .....	<b>111</b>
<b>5.2</b>	<b>NUMBER OF WINDINGS</b> .....	<b>111</b>
<b>5.3</b>	<b>NUMBER OF PHASES</b> .....	<b>111</b>
<b>5.4</b>	<b>COOLING SYSTEM</b> .....	<b>111</b>
<b>5.5</b>	<b>RATED POWER</b> .....	<b>111</b>
<b>5.6</b>	<b>RATED VOLTAGES</b> .....	<b>111</b>
<b>5.7</b>	<b>RATED FREQUENCY</b> .....	<b>111</b>
<b>5.8</b>	<b>VOLTAGE REGULATION</b> .....	<b>112</b>
5.8.1	HV Regulation.....	112
5.8.2	MV Regulation .....	112
<b>5.9</b>	<b>WINDINGS CONNECTIONS</b> .....	<b>112</b>
<b>5.10</b>	<b>INSTALLATION</b> .....	<b>112</b>
<b>5.11</b>	<b>HV AND MV NEUTRAL</b> .....	<b>112</b>
<b>5.12</b>	<b>OVER-LOAD CAPABILITY</b> .....	<b>112</b>
<b>5.13</b>	<b>BUSHINGS</b> .....	<b>112</b>
<b>5.14</b>	<b>INSULATION LEVELS</b> .....	<b>113</b>
<b>5.15</b>	<b>LOSSES AND SHORT CIRCUIT IMPEDANCES</b> .....	<b>113</b>
5.15.1	Losses penalties .....	114
5.15.2	Load loss for coarse/fine type HV regulation.....	114
5.15.3	Load loss for reversing type HV regulation.....	114
<b>5.16</b>	<b>OVER-EXCITATION CONDITIONS</b> .....	<b>114</b>
<b>5.17</b>	<b>NO-LOAD CURRENT</b> .....	<b>114</b>
<b>5.18</b>	<b>OVER-TEMPERATURE OF THE CORE</b> .....	<b>114</b>
<b>5.19</b>	<b>CAPABILITY TO WITHSTAND SHORT-CIRCUIT</b> .....	<b>115</b>
<b>5.20</b>	<b>SOUND LEVELS</b> .....	<b>115</b>
<b>5.21</b>	<b>OVERALL DIMENSIONS</b> .....	<b>115</b>
<b>5.22</b>	<b>RATING PLATES</b> .....	<b>115</b>
<b>5.23</b>	<b>TOLERANCES</b> .....	<b>115</b>
<b>6</b>	<b>DESIGN REQUIREMENTS</b> .....	<b>116</b>
<b>6.1</b>	<b>CORE AND FRAME</b> .....	<b>116</b>
<b>6.2</b>	<b>WINDINGS</b> .....	<b>116</b>
<b>6.3</b>	<b>HV AND MV NEUTRAL</b> .....	<b>116</b>
<b>6.4</b>	<b>TANK</b> .....	<b>116</b>
<b>6.5</b>	<b>INSULATING LIQUID AND MATERIAL</b> .....	<b>116</b>

 	GLOBAL STANDARD	Page 107 of 182
	<b>POWER TRANSFORMERS</b> LOCAL SECTION ENEL DISTRIBUTIE (ROMANIA)	<b>GST002</b> Rev. 01 15/01/2014

<b>6.6</b>	<b>MV WIDINGS CONNECTIONS CHANGE .....</b>	<b>116</b>
<b>6.7</b>	<b>COOLING SYSTEM .....</b>	<b>116</b>
<b>6.8</b>	<b>ACCESSORIES AND AUXILIARIES.....</b>	<b>116</b>
<b>6.9</b>	<b>MARSHALLING BOX .....</b>	<b>119</b>
<b>6.10</b>	<b>PROTECTIVE PAINTING .....</b>	<b>120</b>
<b>7</b>	<b>MAIN COMPONENTS .....</b>	<b>120</b>
<b>7.1</b>	<b>BUSHING GENERAL REQUIREMENTS .....</b>	<b>120</b>
7.1.1	HV Bushings .....	120
7.1.1.1	Ratings.....	120
7.1.1.2	Design requirements .....	121
7.1.1.3	Overall dimensions .....	122
7.1.1.4	Tests.....	122
7.1.2	MV Bushings.....	122
7.1.2.1	Ratings.....	122
7.1.2.2	Design requirements .....	122
7.1.2.3	Overall dimensions .....	122
7.1.2.4	Tests.....	123
<b>7.2</b>	<b>ON LOAD TAP CHANGER .....</b>	<b>123</b>
7.2.1	Ratings.....	123
7.2.2	Design requirements.....	123
7.2.2.1	Painting.....	125
7.2.2.2	Maintenance .....	125
7.2.2.3	Functional requirements .....	125
7.2.3	Tests .....	125
<b>8</b>	<b>TESTS.....</b>	<b>125</b>
<b>8.1</b>	<b>LIST AND CLASSIFICATION OF TESTS .....</b>	<b>125</b>
8.1.1	Routine tests .....	125
8.1.2	Routine tests Additional routine tests for transformers with $U_m \geq 72,5$ KV.....	125
8.1.3	Type tests .....	125
8.1.4	Special tests .....	125
8.1.5	General statement for tests .....	126
8.1.5.1	Short circuit test criteria .....	126
<b>8.2</b>	<b>TESTS DESCRIPTION.....</b>	<b>126</b>
8.2.1	Routine tests .....	126
8.2.1.13	Insulating oil tests .....	126
8.2.1.16	Active part inspection .....	127
8.2.2	Additional routine tests for transformers with $U_m \geq 72,5$ kV .....	127
8.2.3	Type tests .....	127
8.2.3.5	Tests on rating plates .....	127
8.2.4	Special tests .....	127
8.2.4.2	Determination of transient voltage transfer characteristics .....	128
<b>9</b>	<b>SUPPLY REQUIREMENTS.....</b>	<b>128</b>
<b>9.1</b>	<b>TRANSPORT.....</b>	<b>128</b>
<b>9.2</b>	<b>COMMISSIONING .....</b>	<b>128</b>
<b>9.3</b>	<b>DOCUMENTATION.....</b>	<b>128</b>
9.3.1	Documentation for the offer .....	128
9.3.2	Documentation for homologation, certification and approval .....	128
9.3.2.1	Not-reserved documentation (Type A) .....	129
9.3.2.2	Reserved documentation (Type B).....	129

 	GLOBAL STANDARD	Page 108 of 182
	<b>POWER TRANSFORMERS</b> LOCAL SECTION ENEL DISTRIBUTIE (ROMANIA)	<b>GST002</b> Rev. 01 15/01/2014

<b>9.4</b>	<b>GUARANTY .....</b>	<b>129</b>
<b>10</b>	<b>EXCEPTIONS.....</b>	<b>129</b>
<b>11</b>	<b>FIGURES .....</b>	<b>129</b>

 	GLOBAL STANDARD	Page 109 of 182
	<b>POWER TRANSFORMERS</b> LOCAL SECTION ENEL DISTRIBUTIE (ROMANIA)	<b>GST002</b> Rev. 01 15/01/2014

## 1 SCOPE

The scope of this Local Section is to integrate the Common Part in order to provide the technical standard requirements for the power transformers of

- Enel Distributie Banat
- Enel Distributie Dobrogea
- Enel Distributie Muntenia

Each transformer is identified by the type code in the Common List with the specific rated power, rated voltages and the type of connections.

## 2 LIST OF COMPONENTS

See Common List.

## 3 REFERENCE LAWS AND STANDARDS

Here below is reported the list of reference laws and standards relevant for this document.

### 3.1 LAWS

**L 319/2006** – Occupational health and safety act, as amended and supplemented.

**Commission Directive 98/98/EC**, of 15 December 1998 adapting to technical progress for the 25th time Council Directive 67/548/EEC on the approximation of the laws, regulations and administrative provisions relating to the classification, packaging and labeling of dangerous substances.

**Directive 2008/98/EC** of the European Parliament and of the Council of 19 November 2008 on waste and repealing certain Directives.

**L 265/2006** - Environmental Protection Act, as amended and supplemented.

### 3.2 INTERNATIONAL STANDARDS

### 3.3 LOCAL STANDARDS

For Romania the following standards and publications are also to be taken as reference. They refer to the European versions (SR EN – CLC).



SR EN 50216(series) Power transformers and reactor fittings (from Part 1 to Part 12)

SR EN 50180 Bushings above 1 kV up to 36 kV and from 250 A to 3,15 kA for liquid filled Transformers

SR EN 50299 Oil-immersed cable connection assemblies for transformers and reactors having highest voltage for equipment  $U_m$  from 72,5 kV to 550 kV

SR EN 60068-3-3 Environmental testing - Parte 3: Guidance - Seismic test methods for equipments

Copyright 2013. All rights reserved.

 	<b>GLOBAL STANDARD</b>	Page 110 of 182
	<b>POWER TRANSFORMERS</b> LOCAL SECTION ENEL DISTRIBUTIE (ROMANIA)	<b>GST002</b> Rev. 01 15/01/2014

SR EN 60947-7-2	Low-voltage switchgear and controlgear - Part 7: Ancillary equipment - Section 2: Protective conductor terminal blocks for copper conductors
SR EN 13674-1	Railway applications - Track - Rail - Part 1: Vignole railway rails 46 kg/m and above
UNI 4667	Monometri, Vacuometri, Manovacuometri – Rubinetto con attacco ½ Gas – PN 16
SR EN ISO 1461	Requirements for checking hot galvanizing by immersion on ferrous components used in lines and electrical installations
CLC/TS 50458	Capacitance graded outdoor bushing 52 kV up to 420 kV for oil immersed transformers

### 3.4 OTHER RELEVANT DOCUMENTS

ENEL DM 1004	Attacchi a codolo per apparecchiature
ENEL DY 991	Rivestimenti protettivi di apparecchiature e macchinario elettrico
ENEL DY 2101	Prescrizioni per l'esecuzione delle prove di tipo sui rivestimenti protettivi di apparecchiature e macchinario elettrico

### 3.5 REPLACED STANDARDS

UR_P003RO_ ed.03	Transformatoare IT/MT putere nominala 16-25-40 MVA. Caracteristici nominale.
UR_P004RO_ ed.03	Transformatoare IT/MT. Indicatii pentru constructie.
UR_P005RO_ ed.03	Transformatoare IT/MT. Indicatii pentru verificare.
UR_P006RO_ ed.03	Transformatoare IT/MT. Specificatii pentru furnizor.
UR_P007RO_ ed.03	Transformatoare IT/MT. Comutatoare de ploturi sub sarcina.
UR_P008RO_ ed.03	Transformatoare IT/MT. Izolatoare de trecere IT.
UR_P009RO_ ed.03	Izolatori de trecere MT pentru transformatoare trifazice.
UR_P0010RO ed.03	Specificatie pentru sistemul de racire cu radiatoare montate independent.

	GLOBAL STANDARD	Page 111 of 182
	<b>POWER TRANSFORMERS</b> LOCAL SECTION ENEL DISTRIBUTIE (ROMANIA)	<b>GST002</b> Rev. 01 15/01/2014

#### **4 SERVICE CONDITIONS**

The seismic qualification level is: AG5 - EN 60068-3-3.

The Manufacturer shall produce a report to demonstrate the Seismic qualification level required.

#### **5 RATINGS**

The main common transformers for Enel-Distributie are standardized with common rating as indicated in the following.

##### **5.1 TYPES OF TRANSFORMERS**

In the Common List each transformer type is identified with some specific rating with the scope to give a first global view of the main ratings.

##### **5.2 NUMBER OF WINDINGS**

Standard value is 2.

##### **5.3 NUMBER OF PHASES**

Standard value is 3.

##### **5.4 COOLING SYSTEM**

Standard system is ONAN.

##### **5.5 RATED POWER**

Standard values are 16 MVA, 25 MVA, 40 MVA and 63 MVA.

See Common List .

##### **5.6 RATED VOLTAGES**

Standard values for HV side are 115 kV.

Standard values for MV side are 20,8 kV, 10,4 and 20,8-10,4 kV.

See Common List .

##### **5.7 RATED FREQUENCY**

Rated value us 50 Hz.

	<b>GLOBAL STANDARD</b>	Page 112 of 182
	<b>POWER TRANSFORMERS</b> LOCAL SECTION ENEL DISTRIBUTIE (ROMANIA)	<b>GST002</b> Rev. 01 15/01/2014

## 5.8 VOLTAGE REGULATION

### 5.8.1 HV Regulation

Standard value is  $\pm 10 \times 1,5 \%$ .

### 5.8.2 MV Regulation

If required, voltage change and/or voltage regulation and related changing systems are indicated in Common List.

## 5.9 WINDINGS CONNECTIONS

Standard connections is YnD11.

## 5.10 INSTALLATION

Outdoor.

## 5.11 HV AND MV NEUTRAL

The HV neutral connection is permanently earthed directly, but without any intentionally added impedance in the connection.

## 5.12 OVER-LOAD CAPABILITY

## 5.13 BUSHINGS



The bushings shall be selected according to the transformer rated power, the rated voltage and the interfaces in the substation related to the transformers code type in accordance with Table 1.

The type of HV and MV bushing interfaces with the network (O/A – O/O – O/S) for each transformers type code are given in the Common List and the main characteristics of the bushing types are in the relevant sub-clauses of 7.1.

The markings for the bushings are the following:

- for HV: 1U, 1V, 1W, 1N.
- for MV: 2U, 2V, 2W.



 	<b>GLOBAL STANDARD</b>	Page 113 of 182
	<b>POWER TRANSFORMERS</b> LOCAL SECTION ENEL DISTRIBUTIE (ROMANIA)	<b>GST002</b> Rev. 01 15/01/2014

**TABLE 1 - MV BUSHINGS TYPE**

Rated Power (MVA)	MV Bushing type			HV Bushing type
	MV Rated Voltage (kV)			Connection type
	10,4	20,8	20,8-10,4	Overhead Line
16	DJ 1106/3	DJ 1106/3	DJ 1106/4	DJ 1104/1
25	DJ 1106/4	DJ 1106/3	DJ 1106/4	
40	DJ 1106/4	DJ 1106/4	DJ 1106/5	
63	DJ 1106/5	DJ 1106/5	--	DJ 1104/2

#### 5.14 INSULATION LEVELS

The prescribed insulation levels are indicated in Table 2.

**TABLE 2 – INSULATION LEVELS**

Rated Voltage Ur (kV)	Highest Voltage for equipment Um (kV)	Tests		
		Lightning impulse LI (kV)	Short duration AC (kV)	Separate source AC ACSD (kV)
115	145	550	230	230
20,8	24	125	50	resulting
10,4	24	75	50	resulting

#### 5.15 LOSSES AND SHORT CIRCUIT IMPEDANCES



The losses value shall be in compliance with the PEI (Peak Efficiency Index) values reported in the Annex D for each corresponding rated power.

The prescribed short circuit impedances are also given in the Table 3.

**TABLE 3 - LOSSES AND SHORT CIRCUIT IMPEDANCES**

Rated Power (MVA)	No-Load Losses (NLL) (%)	Load Losses (LL) (%)	Short circuit impedance with the tap changer positioned on: <sup>(1)</sup>		
			Min. tap (%)	Central tap (%)	Max. tap (%)
16	PEI		12,2	13	14,1
25	PEI		13,7	14,6	15,8
40	PEI		14,6	15,5	16,8
63	PEI		21,2	22,5	24,2

<sup>(1)</sup> The above prescribed values of short circuit impedance are sufficiently high to take into account that the HV regulation could be either of the reversing type or coarse-fine type.

 	GLOBAL STANDARD	Page 114 of 182
	<b>POWER TRANSFORMERS</b> LOCAL SECTION ENEL DISTRIBUTIE (ROMANIA)	<b>GST002</b> Rev. 01 15/01/2014

PEI values at rated voltage position has to be respected without any tolerances and moreover the single loss value shall not be higher than the below indicated values with the tolerances reported in the relevant clause.

- 16 MVA: NLL 12 KW – LL 88 kW
- 25 MVA: NLL 16 KW – LL 122 kW
- 40 MVA: NLL 23 KW – LL 186 kW
- 63 MVA: NLL 32 KW – LL 282 kW

### 5.15.1 Losses penalties

In case losses exceed the maximum values prescribed beyond the tolerances of 5,23, the following penalty rates apply part exceeding the maximum values prescribed.

- A = 3500 €/KW
- B = 1600 €/KW

### 5.15.2 Load loss for coarse/fine type HV regulation

In case of coarse-fine type on-load tap changer, the load losses are referred to the condition with the tap changer positioned on the central tap, in such a way that the “rough” regulation is connected while the “fine” regulation is disconnected.

In the condition of the tap-changer is positioned on the central tap, with the “rough” regulation disconnected while the “fine” regulation connected, the prescribed value is higher by the 5%.

### 5.15.3 Load loss for reversing type HV regulation

In case of inversion-type on-load tap changer, the load losses are determined with the following equation:

$$P_c = \frac{2 \cdot P_1 + P_2 + P_3}{4}$$

Where:

P<sub>1</sub> = load losses measured with the on-load tap changer positioned on the central tap

P<sub>2</sub> = load losses measured with the on-load tap changer positioned on the minimal tap

P<sub>3</sub> = load losses measured with the on-load tap changer positioned on the maximal tap

## 5.16 OVER-EXCITATION CONDITIONS

## 5.17 NO-LOAD CURRENT

## 5.18 OVER-TEMPERATURE OF THE CORE

For transformers with rated power of 63 MVA or larger, the surface over-temperature of the core shall not exceed 75 °C.

	<b>GLOBAL STANDARD</b>	Page 115 of 182
	<b>POWER TRANSFORMERS</b> LOCAL SECTION ENEL DISTRIBUTIE (ROMANIA)	<b>GST002</b> Rev. 01 15/01/2014

### 5.19 CAPABILITY TO WITHSTAND SHORT-CIRCUIT

### 5.20 SOUND LEVELS

The prescribed sound power level is given in the following Table 4.

**TABLE 4: SOUND POWER LEVEL**

Rated Power (MVA)	Sound Power Level dB(A)
16	67
25	
40	70
63	74

### 5.21 OVERALL DIMENSIONS

The dimensions and the position of the main accessories, are shown in the Figures listed below.

Transformers with oil/air HV bushings: Figures 1, 2 and 3.

Supporting plates: Figure 4.

### 5.22 RATING PLATES

The rating plates dimensions, together with the models, are reported, for both transformers with single and double level of MV voltage in Figures 5, 6 and 7.

### 5.23 TOLERANCES

The admitted tolerances on the prescribed values are the ones of EN 60076-1.

With reference to the prescribed values for the losses, a free zone within which no penalties are applied is defined as below:

- No tolerance is admitted on the PEI values prescribed
- + 5% for the no-load loss values indicated
- + 2.5% for the load loss values indicated
- No tolerance is admitted on the sound power level prescribed.

	GLOBAL STANDARD	Page 116 of 182
	<b>POWER TRANSFORMERS</b> LOCAL SECTION ENEL DISTRIBUTIE (ROMANIA)	<b>GST002</b> Rev. 01 15/01/2014

## 6 DESIGN REQUIREMENTS

### 6.1 CORE AND FRAME

### 6.2 WINDINGS

### 6.3 HV AND MV NEUTRAL

### 6.4 TANK

The tank shall be provided with the following parts, located as shown in the Figures of the overall dimensions:

- Supporting plates on the base for the lay down of the transformer, provided with holed bolts to allow, eventually, the installation of wheels;
- Shelf plates on the base for the lifting of the transformer through jacks.

### 6.5 INSULATING LIQUID AND MATERIAL

The insulating liquid shall be mineral oil uninhibited, identified with the U letter without any anti-oxidant additive, accordingly to IEC 60296.

For the classification of dangerous oil, the romanian reference law is 265/2006 - Environmental Protection Act, as amended and supplemented.

The specific risk for oils classified as dangerous are identified by the "risks statements R45, R46 and R49", listed in law 265/2006.

### 6.6 MV WIDINGS CONNECTIONS CHANGE

For transformer with double voltage level of the MV windings (i.e. 20,8-10,4 kV), the voltage changing shall be made by an in-tank bar connection located under the tank cover, accessible trough a specific windows, after lowering of the oil level.

### 6.7 COOLING SYSTEM

The cooling of the transformers shall be ONAN, made by radiators directly connected to the tank through flanges with the interposition of proper butterfly valves as prescribed in 6.8 in order to remove radiators without emptying the oil from the tank.

### 6.8 ACCESSORIES AND AUXILIARIES

The mechanical and electrical accessories shall be compliant with SR EN 50216, unless otherwise specified.

The screws for the couplings among the different components shall be of stainless steel or galvanized.

The cases of all the devices shall be IP 55 accordingly to SR EN 60529, unless otherwise specified.

Copyright 2013. All rights reserved.

	GLOBAL STANDARD	Page 117 of 182
	<b>POWER TRANSFORMERS</b> LOCAL SECTION ENEL DISTRIBUTIE (ROMANIA)	<b>GST002</b> Rev. 01 15/01/2014

Each transformer shall be provided with the accessories specified in the following.



- 1) **Conservator**, adapt to compensate the oil volume variation in the range – 25 °C; + 90 °C. The conservator shall have two compartments. The main for the transformer and a second appropriate to be used for the oil of the on-load tap changer. The oils in the two compartments shall be kept separated.
  - 1a) **Oil level indicator** with the levels – 20 °C, + 20 °C, + 85 °C and electric contacts for the minimum level alarm;
  - 1b) **Tap for oil filling;**
  - 1c) **Tap for draining the oil;**
  - 1d) **Window for the inspection;**
  - 1e) **Piping system for the dehydrating breather connections.**
  
- 2) **Radiators** in compliance with SR EN 50216-6 and moreover:
  - Able to withstand vacuum conditions;
  - Painted with the same protective cover of the tank.

The coupling of the radiators and the tank shall be made in order to ensure the metallic continuity.
  
- 3) **Two butterfly valves for each radiator**, in compliance with SR EN 50216-8, on the connection pipes on the tank side.
  
- 4) **Blind flange with washer** for locking the butterfly valves of the previous item.
  
- 5) **Dehydrating breathers** with hygroscopic substances (maintenance free), one for each compartment, mounted at head height.
 

The two dehydrating breathers can be replaced by only one device, provided that the dimensioning is made taking into account the total oil content. In this case the two separated compartments in the conservator shall be however maintained, and they shall be connected to the dehydrating breather through a unique pipe (without interception valves).

Note: for the 63 MVA transformers, which contain larger amount of oil than the smaller transformers, generally the dehydrating breathers suppliers recommend the use of more dimensioned devices or the use of two devices.

The oil dehydrating devices shall be cobalt free, accordingly to EU Directive UE 98/98/CE.
  
- 6) **Window for the inspection**, at least one appropriately protected against accidental impacts, to be mounted on the cover tank for checking the oil treatment.
  
- 7) **One bronze tap for oil sampling**, with spherical moving element, for oil samples taking with female plug-in Gj 1/2" UNI 4667 or equivalent, provided with male cap T9 1/2" gas with chainlet; such a device shall be mounted no lower than 60 mm from the bottom.
  
- 8) **Two bronze taps for oil treatment**, with spherical moving element, with male plug-in Gc 1" 1/2 gas UNI 4667 or equivalent, provided with nut caps T 1 - 1" 1/2 gas with chainlet. The two taps shall be mounted close to each other, on the lower part of the tank, and shall be connected through pipelines to two diametrically opposite zones of the tank, in such a way to allow an optimal re-circulation of the oil. The tap mounted on the lower part shall serve also for the draining of the oil.

 	GLOBAL STANDARD	Page 118 of 182
	<b>POWER TRANSFORMERS</b> LOCAL SECTION ENEL DISTRIBUTIE (ROMANIA)	<b>GST002</b> Rev. 01 15/01/2014

- 9) **Two taps for oil treatment of the diverter switch compartment of the OLTC.**
- 10) **One bronze tap vacuum pump**, with spherical moving element, with male plug-in Gc 1" 1/2 gas UNI 4667, provided with nut caps T 1 - 1" 1/2 gas with chain.
- 11) **Three thermometer pockets** for the temperature measurement of the top oil, accordingly to SR EN 50216-4 type- A1, one of which will be used for the probe of the quadrant thermometer and the others will remain available.
- 12) **One quadrant thermometer** compliant with SR EN 50216-11 for the oil temperature measurement, elastically fixed at the tank, provided with settable electric contacts for the maximum temperature alarm, with independent electric circuits. The following thresholds shall be set:
  - Alarm threshold: 95 °C
  - Tripping threshold: 105 °C
- 13) **The hooks for lifting** the completely assembled transformer, the extractable part (cover and active part) and for the conservator .
- 14) **Hooks for horizontal movement** of transformer to the two orthogonal directions, to be positioned at the bottom of the transformer, close to the base.
- 15) **Two grounding terminals** on the tank, each of which consisting of a plate with dimensions 90x50x15 with two threaded holes M16 positioned at the base of the tank (approximately at the middle of the longest sides) and shall be marked with two name plates with the grounding symbol (black symbol on a yellow background).
- 16) **Interception valves of the butterfly type**, to be mounted both upstream and downstream of each of the relays required (items 18, 19, 26 and 28).
- 17) **Flanged pipelines trunks** in case of relays removal (items 18, 19).
- 18) **One Buchholz relay**, mounted in the pipeline which connects the conservator and the tank, with two with independent contacts (alarm and tripping), related electrical control circuit. An additional device for the gas storage shall be provided and mounted at head height on the tank.  
The set up of the tripping contacts for oil flux shall be 1,5 m/s.
- 19) **Oil flow relay for OLTC**, mounted in the pipeline which connects the compartment of the diverter switch of the OLTC and the relevant conservator compartment.
- 20) **Two thermal resistances for the surface core temperature measurement**, of platinum of 100 ohms at 0° C, with the temperature coefficient  $3,85 \times 10^{-3} \text{ } ^\circ\text{C}^{-1}$ , and with shielded terminals.  
  
One thermal resistance shall be mounted at the central column in correspondence to the cross with the top yoke; the other shall be mounted on the cover of the top yoke, in correspondence to the central column and inserted into a cooling pipeline of the core, if existing.  
  
The relevant wire shall be brought to the marshalling box (for checking the core over temperature).
- 21) **Over pressure valves**, at least one to prevent pressure increasing inside the tank in case of internal fault.
- 22) **Specific fall arrest system for the operator**, if specifically requested.

	GLOBAL STANDARD	Page 119 of 182
	<b>POWER TRANSFORMERS</b> LOCAL SECTION ENEL DISTRIBUTIE (ROMANIA)	<b>GST002</b> Rev. 01 15/01/2014

23) **Adjustable sliding rolls**, in compliance with SR EN 13674-1, if specifically requested..

## 6.9 MARSHALLING BOX

All the electric circuits of the auxiliaries shall be attested to the marshalling box.

The identification of the connectors shall be in Local Language as reported in the attached Figures (translation is also given attached).

The marshalling box shall be installed on the tank in the shorter side opposite to the MV bushings.

The box shall have an IP 55 protection degree according to SR EN 60529 and shall be provided with appropriate door, laterally hinged, to be opened with either special key or removable door handle.

The box shall be realized with either stainless steel sheets or hot zinc-coated (SR EN ISO 1461 Standard) or with metallic not subject to corrosion. The box shall be painted with colour 7031 of the RAL F2 scale by using painting cycles complaint with DY 991.

The box shall contain:

- 1) **Lamp and single phase sock 230 V - 10 A**, inserted in the warming circuit.
- 2) **Heating resistances** - One for the removal of the moisture always active and a second one activated by thermostat and protected by an automatic circuit bracker with NC contact provided in the marshalling box.
- 3) **Marshallings** detailed in Figures 8, 9 and 10.
- 4) **Earth collector** consisting of a copper plate 25 x 3 mm<sup>2</sup> for the grounding of all the metallic parts and of the cable shields.

All connections wires shall have appropriate sections both with regard to the nominal operating current and the short circuit current (4,5 kA) of the power supply. All the wires conveying signals and to the actuations shall be realized with appropriate section conductors, in any case not smaller than 1,5 mm<sup>2</sup>.

Wirings inside the cabinet shall be "not fire not-spreading", with insulation level  $U_0/U = 450/750$  V. At the terminals of the flexible conductors shall be applied compressed pre-insulated terminals and these terminals shall be identifiable with appropriate marks and/or indications.

All the wires for the connection between the marshalling box cabinet and the devices (apparatuses/auxiliaries) mounted on the transformer shall be laid into rigid steel pipelines; only terminals/trunks wires entering inside the devices and the cabinet could be laid, alternatively, into flexible pipelines. The flexible pipelines, withstanding to accidental impacts and crushings and the relevant screws, shall be made by stainless material.

The supply voltage shall be:

- for the warming circuit 230 V  $\pm$  10%, 50 Hz
- For the signalling and protection circuits 110 V +10% -15% c.c.

The marshalling installed inside the box shall be of the modular type and structured as in the following:

- Marshalling box for the transformer see Figures 8 and 9
- Marshalling box for the on-load tap changer see Figure 10

	GLOBAL STANDARD	Page 120 of 182
	<b>POWER TRANSFORMERS</b> LOCAL SECTION ENEL DISTRIBUTIE (ROMANIA)	<b>GST002</b> Rev. 01 15/01/2014

The clamps shall be at indirect tightening for both the rigid and flexible wires of section up to 4 mm<sup>2</sup>, compliant with SR EN 60947-7-2 and mounted on an appropriate metallic support.

The clumps shall be provided with appropriate name plates reporting the marks in compliance with the above mentioned Figure 8 and Figure 9. The marshalling boxes and the eventual pipelines of the conductors shall be mounted in such a way that to facilitate the wirings of the conductors. In particular, between the gland plane and the marshalling boxes shall be left appropriate distances in order to facilitate the stripping of the cable and the connection of the cable shields to the eathing collector.

## 6.10 PROTECTIVE PAINTING

Painting cycles for pollution level “High or Very high”, can be proposed by the transformer supplier and approved by ENEL.

Unless otherwise agreed, Enel Distributie technical specifications DY 991/1 and DY 2101 apply.

The colour of the final painted layer shall be blue grey RAL 7031.

In the Enel specification DY 991 the preparation modes of the surfaces to protect are indicated.

The internal surfaces of the transformer (including the conservator) shall be protected with the painting withstanding the hot oil (maximal temperature 110°C).

## 7 MAIN COMPONENTS

### 7.1 BUSHING GENERAL REQUIREMENTS



The oil/air bushings HV and MV shall be of polymeric type.

#### 7.1.1 HV Bushings

##### 7.1.1.1 Ratings

The interchangeability of the bushings shall be accordingly to EN CLC/TS 50458 standard and the characteristics reported in the following Table 5.



 	GLOBAL STANDARD	Page 121 of 182
	POWER TRANSFORMERS LOCAL SECTION ENEL DISTRIBUTIE (ROMANIA)	GST002 Rev. 01 15/01/2014

**TABLE 5 – HV BUSHINGS CLASSIFICATION**

Type of Bushing		O/A	O/A
Enel Code		DJ1104/1	DJ1104/2
Drawings and interfaces		Fig.11 + Part.A	
Dimensions: L, L1, L2, L3, L4		(*)	(*)
Designation accordingly to CLC/TS 50458		NRUE0	NRUE0
<b>Ratings</b>			
Rated voltage (Ur)	(kV)	145	170
Rated phase-to-ground voltage	(kV)	145/√3	170/√3
Rated frequency	(Hz)	50	50
Power frequency withstand voltage	(kV)	230	275
Lightning impulse withstand voltage	(kV) peak	550	650
Rated current (Ir)	(A)	400	400
Rated short duration thermal current (I <sub>th</sub> ) for 2s	(kA)	10	10
Dynamic rated current (I <sub>d</sub> )	(kA) peak	25	25
Cantilever test	(N)	1250	1250
Allowable inclination		≤ 30°	≤ 30°
Minimum pollution level level SPS Class (IEC 60815)		D-Heavy	D-Heavy
RUSCD	(mm/kV)	43,3	43,3
Creepage distance	(mm)	3625	4250
<b>Operating conditions:</b> accordingly to the prescriptions of the transformer and in compliance with IEC 60137			
(*) Under the Supplier responsibility in accordance to the dimensions specified for the transformer			
(**) The Supplier shall verify the interfaces of the transformer with the substation in order to ensure the proper connection (if necessary, the Supplier shall provide proper junctions)			

### 7.1.1.2 Design requirements

The oil-air bushings shall be of polymeric type.

The HV terminals shall be disassemblable from outside and shall be complaint with Enel prescription DM1004.

Metallic parts shall be in aluminum alloy, stainless steel, or hot galvanized in compliance with SR EN ISO 1461 standard.

Each bushing shall be provided with the following accessories:

- 1) **Power factor tap** for measurement of the capacitance-to-ground. The Supplier shall provide drawings for the correct usage of the tap and for the inspections.
- 2) **Pressure relief cap** of 1/2" gas.

Copyright 2013. All rights reserved.

	GLOBAL STANDARD	Page 122 of 182
	<b>POWER TRANSFORMERS</b> LOCAL SECTION ENEL DISTRIBUTIE (ROMANIA)	<b>GST002</b> Rev. 01 15/01/2014

- 3) **Compensator for the oil volume variation.**
- 4) **Oil level indicator**, for the oil-air bushing type.

The accessories enlisted in the items 1-2 shall be mounted on the flange.

The minimal set of requirements for the electric contacts of the oil under/over pressure alarm of the pressure gauge, which shall be normally opened, are indicated in the following Table.

**TABLE 7 – REQUIREMENTS FOR ELECTRIC CONTACTS**

Rated Voltage	110-140 Vdc	230 Vac
Rated Current	2 A	2 A
Power frequency insulation level to ground	2.000 V	2.500 V
Power frequency insulation level between opened contacts	1.000 V	1.000 V
Breaking capacity referred to 100.000 switches	250 W - L/R = 40 ms	400 VA - $\cos\phi > 0,5$

#### 7.1.1.3 Overall dimensions

The dimensions and the interfaces for the connection with HV un-covered overhead lines are specified in Figure 11.

#### 7.1.1.4 Tests

The following additional test are required

##### **Verification of the proper functioning of the pressure gauge (if any)**

To be performed by simulating the activation/intervention conditions. The insulation to ground shall be tested at 2 kV, power frequency, 60 s. No discharge or perforations shall occur.

##### **Verification of the protective coating**

It shall be verified that the protective coating is adequate. In case of zinc-coated metallic parts, the zinc layer shall be verified with the magnetic method accordingly to SR EN ISO 2178.

#### 7.1.2 MV Bushings

The bushings shall be compliant with SR EN 50180.

##### 7.1.2.1 Ratings

##### 7.1.2.2 Design requirements

The bushings shall be of polymeric type.

##### 7.1.2.3 Overall dimensions

Dimension and typologies are reported in Figure 12.

	GLOBAL STANDARD	Page 123 of 182
	<b>POWER TRANSFORMERS</b> LOCAL SECTION ENEL DISTRIBUTIE (ROMANIA)	<b>GST002</b> Rev. 01 15/01/2014

#### 7.1.2.4 Tests

### 7.2 ON LOAD TAP CHANGER

#### 7.2.1 Ratings

The on load tap changer shall be vacuum type.

The regulating positions shall be in accordance with the transformer ratings.

The On Load Tap Changer shall be in accordance with the transformer characteristics with the change over selector either fine coarse type or reversing type.

#### 7.2.2 Design requirements

##### Diverter switch

The diverter switch contains an energy storage device, a set of moving and fixed contacts and the commutation resistances.

The diverter switch shall be installed into a sealed chamber which has to ensure the separation with the oil of the transformer. This chamber shall be connected with the relevant compartment contained into the main conservator of the transformer.

The diverter switch shall be moreover provided with the following devices:

- 1) Relays for the oil flux control (prescribed in item 19 of clause 6.8).
- 2) Pressure limitation device (rupture disk).

The diverter switch shall be easily to be inspected, and able to allow the maintenance operations and/or replacement without requiring the opening of transformer's tank.

##### OLTC driving mechanism

The OLTC shall be driven by a mechanism contained into a box, installed outside the tank of the transformer.

The moving mechanical parts connecting the motor drive and the diverter switch shall be fully protected with appropriate carters.



The commutation of the diverter switch shall be activated by an energy store device; the energy charge shall be achievable both through a motor drive and manually.

The motor drive commutation shall be achievable both remotely and locally through electric signals.

When the crank handle is inserted, the electric/motorized commutation shall be inhibited through the interruption of both the supply circuit and the electric signalling circuit.

##### Tap-Selector and change-over selector

The tap-selector and the change-over selector shall be for installation inside the transformer tank.

 	GLOBAL STANDARD	Page 124 of 182
	<b>POWER TRANSFORMERS</b> LOCAL SECTION ENEL DISTRIBUTIE (ROMANIA)	<b>GST002</b> Rev. 01 15/01/2014

## Cabinet

The OLTC control and driving devices shall be positioned inside a box, fixed on the transformer tank.

The box shall be manufactured with hot painted or galvanized steel sheets or with metal not susceptible to corrosion and painted accordingly to the prescription given in 6.10.

The box shall have an IP55 protection degree in compliance with IEC 60529 and shall be provided with an appropriate door, laterally hinged and lockable.

On the door, a window, protected with transparent material withstanding the atmospheric agents and UV radiations, which allow the visualization of the position indicator of the OLTC, shall be fitted.

The wires for the power supply shall have adequate sections in order to withstand the short-circuit current (4,5 kA) of the supply.

All the wiring relevant to the signalling and command circuits (supplied at 100÷140 Vcc or 230 Vac) shall have a section not smaller than 1,5 mm<sup>2</sup>.

The wires for the connections inside the box shall be of the not-fire-propagate type, with insulating level U<sub>0</sub>/U = 450/750 V; to the extremes of the flexible wires shall be applied pre-insulated compressed terminals and the extremes themselves shall be identifiable with appropriate marks.

The plugs of the marshalling shall be indirectly tightened, and shall be in compliance with SR EN 60947-7-2 and fixed on appropriate metallic support.



In the box shall be located:

- 1) Push buttons or crank for the on-site electric commutation provided with the labels "increase MV" and "decrease MV"
- 2) Motor gear and the electrical devices for its command
- 3) Automatic circuit bracker on the motor circuit, provided with NC contacts wires in the marshalling
- 4) Heating anti-moisture resistance (always on) and additional heating resistance controlled by a thermostat and protected with automatic circuit bracher, provided with NC contacts wire in the marshalling, or with an equivalent system preventing the moisture generation
- 5) Ground terminal for of all the metallic parts of the box
- 6) Lamp and one single-phase
- 7) Socket 230V, 10 A, supply by the heating circuit
- 8) The protection and signalling devices;
- 9) One marshalling for the interface with the marshalling box of the transformer.

The supply voltages shall be:

- |                                      |                    |
|--------------------------------------|--------------------|
| ▪ Three phase motor                  | 400 V ± 10%, 50 Hz |
| ▪ Command circuits                   | 230 V ± 10%, 50 Hz |
| ▪ Heating system                     | 230 V ± 10%, 50 Hz |
| ▪ Protection and signalling circuits | 100÷140 Vdc        |

The requirements for the contacts, which allow the convey of the signals to the marshalling box, are defined in the Table 7.

 	<b>GLOBAL STANDARD</b>	Page 125 of 182
	<b>POWER TRANSFORMERS</b> LOCAL SECTION ENEL DISTRIBUTIE (ROMANIA)	<b>GST002</b> Rev. 01 15/01/2014

The marshalling of the motor drive is reported in Figure 10 .

#### **7.2.2.1 Painting**

#### **7.2.2.2 Maintenance**

#### **7.2.2.3 Functional requirements**

The main functional requirements are the following.

- 1) The execution of the commutation shall be inhibited or interrupted when the over-current arrest relays (I max) installed outside the diverter switch activates
- 2) A device that allows the completion of a tap commutation already started, regardless of the control activation time
- 3) A device that prevents the execution of more than one commutation in case of control button pushed longer than time necessary to activate the commutation
- 4) An electrical and/or mechanical device for the motor drive re-starting after an interruption of the supply voltage, in order to complete a commutation already started
- 5) An electrical and a mechanical block that prevents commutations beyond the extreme positions
- 6) An electrical device that prevents the activation of an increasing commutation while a decreasing commutation is in operation and vice versa
- 7) A mechanical indicator of the position. The main central position shall be indicated with zero, the other positions shall correspond to the progressive number +1, +2, etc. e -1, -2, etc. from the central position respectively for increasing and decreasing the taps of the HV winding
- 8) Electrical contacts for the indication of the tap positions
- 9) Counter with 6 digits for the indication of the commutations number

#### **7.2.3 Tests**

### **8 TESTS**

#### **8.1 LIST AND CLASSIFICATION OF TESTS**

##### **8.1.1 Routine tests**

- 13) Insulating oil tests.
- 16) Active part inspection.

##### **8.1.2 Routine tests Additional routine tests for transformers with $U_m \geq 72,5$ KV**

##### **8.1.3 Type tests**

- 5) Tests on the rating plate.

##### **8.1.4 Special tests**

- 2) Determination of transient voltage characteristics

	GLOBAL STANDARD	Page 126 of 182
	<b>POWER TRANSFORMERS</b> LOCAL SECTION ENEL DISTRIBUTIE (ROMANIA)	<b>GST002</b> Rev. 01 15/01/2014

## 8.1.5 General statement for tests

### 8.1.5.1 Short circuit test criteria

## 8.2 TESTS DESCRIPTION

### 8.2.1 Routine tests

#### 8.2.1.13 Insulating oil tests

##### Certification of the oil

The new oil employed in the transformer shall be provided with the certificate which contains all the parameters prescribed in the IEC 60296 – Table 2, with the following additional specifications:

- The absence of corrosive sulphur shall be determined with the ASTM D1275 Method B, or with the more recent CCD method of IEC 62535
- The absence of DBDS shall be verified
- The oil Supplier shall declare possible anti-oxidant additives (type and concentration), if they are present.

For the above listed verifications the certification of the oil Supplier can be accepted. Such documentation shall however be included in the tests report documentation of the transformer.

##### Verification of the oil directly spilled from the transformer under test.

In the following parts the tests to be performed are specified. The two following possibilities are considered:

- A) Where the transformer is under certification, homologation (or updating of certification or homologation) or approval
- B) Where the transformer is under routine tests.



The documentation of the tests of the oil shall be enclosed in the test report of the transformer.

##### A) Certification, homologation or approval

The Manufacturer shall take the commitment to perform in an accredited independent laboratory, on an oil sample taken from the tank, the verifications below enlisted, according to the criteria defined in the IEC 60422–Table 3, where applicable and not otherwise specified:

- All the acceptance tests listed in B).
- Resistivity at 90°C.
- Oxidation stability.
- Interfacial tension (IFT).
- the absence of anti-oxidant additives shall be verified (IEC 60666 – verification of the “U” classification – not-inhibited oil).
- the absence of the DBDS shall be verified with a proper method.

Note: in case of transformer prototypes whose certifications are carried out within a short period (less than 4 months), for the subsequent prototype/s it is possible to perform only the acceptance test listed in B), if the oil producer and the oil type are the same.

 	GLOBAL STANDARD	Page 127 of 182
	<b>POWER TRANSFORMERS</b> LOCAL SECTION ENEL DISTRIBUTIE (ROMANIA)	<b>GST002</b> Rev. 01 15/01/2014

## B) Acceptance tests

- Colour and appearance.
- Breakdown voltage<sup>(1)</sup>.
- Water content.
- Acidity (neutralization value).
- Dielectric dissipation factor (DDF) at 90° C.
- PCB content.
- 2-furfural content (IEC 61198 - limit 0,1 mg/kg)
- the absence of corrosive sulphur shall be determined with reference to the ASTM D1275 B method or with reference to the more recent CCD – IEC 62535 method

<sup>(1)</sup> when the transformer is under routine tests, the breakdown voltage can be performed at the Manufacturer factory with the presence of the Enel representative.

### 8.2.1.16 Active part inspection

The active part shall be inspected by Enel representative, before the assembling into the tank. The manufacturer shall communicate to Enel the date of the active part inspection at least 15 days in advance in case of the factory location is in Italy or one month in case of the factory location is abroad.

At the date of the active part inspection, the continuously transposed cable mechanical test report (shall be already available).

### 8.2.2 Additional routine tests for transformers with $U_m \geq 72,5$ kV

#### 8.2.3 Type tests

##### 8.2.3.5 Tests on rating plates

Three type tests, for each rating plate supplier, shall be executed. Such tests, to be executed on n° 9 rating plates (n° 3 for each test) shall be performed accordingly to the prescriptions given in ENEL DY 2101, unless otherwise specified.

##### Accelerated ageing test

The test duration shall be 1000 hours. At the end of the test, no alterations on the film shall occur (cracks, detaching, or presence of “blister”).



##### Salt-foggy chamber withstand test

The test duration shall be 1000 hours. At the end of the test, no alterations on the film shall occur (cracks, detaching, or presence of “blister”).

##### Abrasion withstand test

At the end of the test, the abrasion coefficient shall not be lower than 1,2 on all the rating plates tested.

### 8.2.4 Special tests

 	GLOBAL STANDARD	Page 128 of 182
	<b>POWER TRANSFORMERS</b> LOCAL SECTION ENEL DISTRIBUTIE (ROMANIA)	<b>GST002</b> Rev. 01 15/01/2014

#### 8.2.4.2 Determination of transient voltage transfer characteristics

The scope of the test is to check the characteristics of the over-voltages transferred by a low voltage impulse generator (1,2/100  $\mu$ s).

The impulse shall be applied between the HV terminal and earth in sequence. The HV terminals not impulsed shall be connected to earth by a 500  $\Omega$ /phase.

The MV terminals shall be in the following conditions:

- all terminals earthed by 500  $\Omega$ /phase resistors (1 config. for HV phase);
- all terminals free (1 config. for HV phase);
- each terminal earthed by a 500  $\Omega$  resistor, sequentially (3 config. for HV phase);
- one free and the other terminals connected to ground (3 config. for HV phase).

For each configuration the voltage applied and the voltage transferred on the MV terminals and between them and earth shall be recorded.

The test is passed if the MV over-voltages determined by reporting the HV impulse at the rated impulse values are not higher than the corresponding insulation value for the same MV terminal.

Note: in case of value exceeding the above defined acceptable value further considerations about the transformer in operation are necessary.

## 9 SUPPLY REQUIREMENTS

### 9.1 TRANSPORT

The transformers with rated power of 16 MVA and 25 MVA shall be transportable in operating conditions (full of oil and fully assembled with bushings, radiators, conservator etc).

The transformers of 40 MVA and 63 MVA shall be transportable with the oil level decreased at the tank level and by disassembling HV bushings, radiators and conservator.



### 9.2 COMMISSIONING

### 9.3 DOCUMENTATION

#### 9.3.1 Documentation for the offer

#### 9.3.2 Documentation for homologation, certification and approval



 	<b>GLOBAL STANDARD</b>	Page 129 of 182
	<b>POWER TRANSFORMERS</b> LOCAL SECTION ENEL DISTRIBUTIE (ROMANIA)	<b>GST002</b> Rev. 01 15/01/2014

### 9.3.2.1 Not-reserved documentation (Type A)

### 9.3.2.2 Reserved documentation (Type B)

## 9.4 GUARANTY

The general criteria of scheduled maintenance performed by Enel-Distribuzione are reported in the following Table. The maintenance activities are recorded by Enel managing system.



**TABLE 8: MAINTENANCE ACITVITIES**

Activity	Frequency
Visual inspection	3 months
Inspection with infrared camera	1 years
DGA (internal procedure based on IEC 60599) Verification of oil parameters (internal procedure based on IEC 60422)	2 years
Bushings cleaning Check of the cooling system Check of transformers and OLTC control cabinets Check and cleaning of oil indicators and thermal probes Check of Buchholz relays of the transformers and oil flux relays of OLTC Any other verification when necessary	5 years
The frequency of the reported activities can be increase in case of specific needs	

## 10 EXCEPTIONS

## 11 FIGURES



In the following all the Figures mentioned in this Local Sections are reported.

 	GLOBAL STANDARD	Page 130 of 182
	<b>POWER TRANSFORMERS</b> LOCAL SECTION ENEL DISTRIBUTIE (ROMANIA)	<b>GST002</b> Rev. 01 15/01/2014

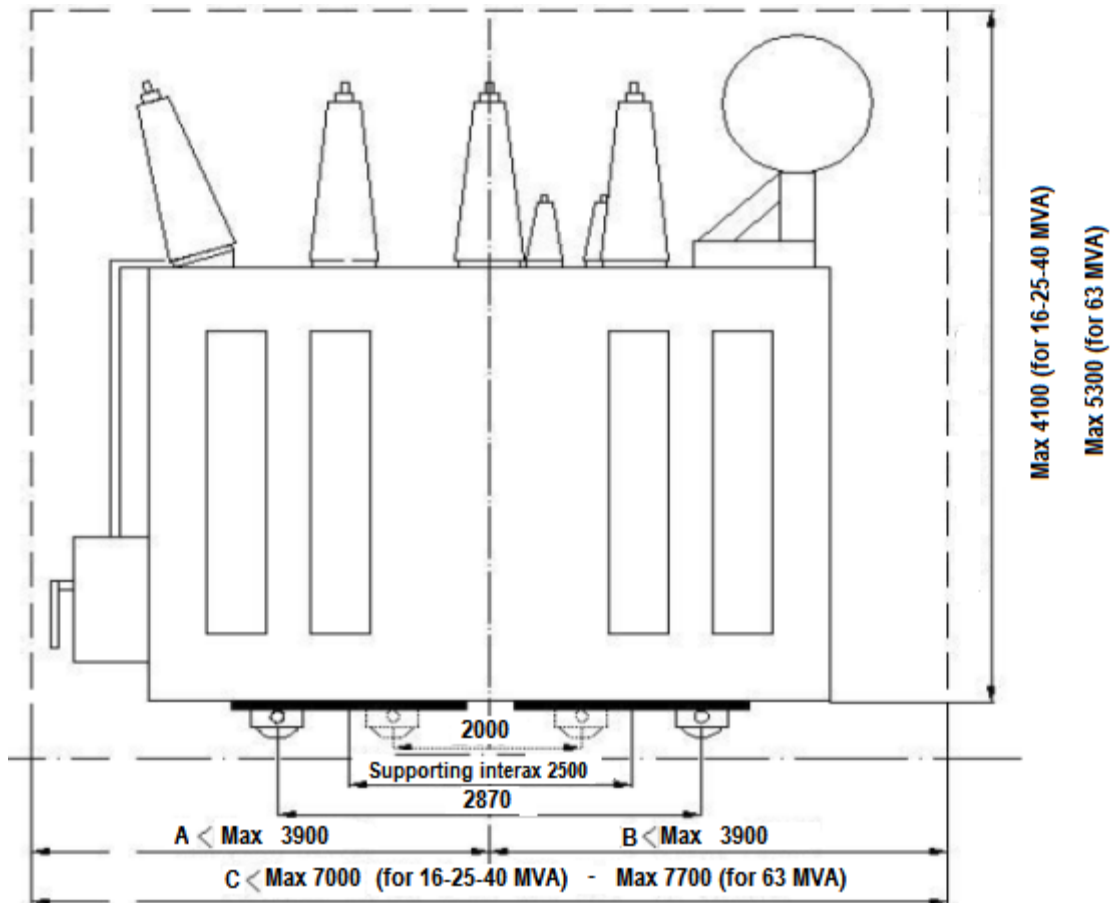
**FIGURE 1 – FRONTAL VIEW OF THE HV SIDE (FOR AIR LINES CONNECTIONS)**





- 1) The bushings can be inclined at max. 30° from the vertical
- 2) The possible radiators installed on the shorter side of the transformer shall not overcome, with their top, the horizontal plane identified by the base of the hollow insulator
- 3)  $A+B = C < 7000 \text{ (for 16-25-40 MVA)} \text{ or } 7700 \text{ (for 63 MVA)}$

 	GLOBAL STANDARD	Page 131 of 182
	<b>POWER TRANSFORMERS</b> LOCAL SECTION ENEL DISTRIBUTIE (ROMANIA)	<b>GST002</b> Rev. 01 15/01/2014

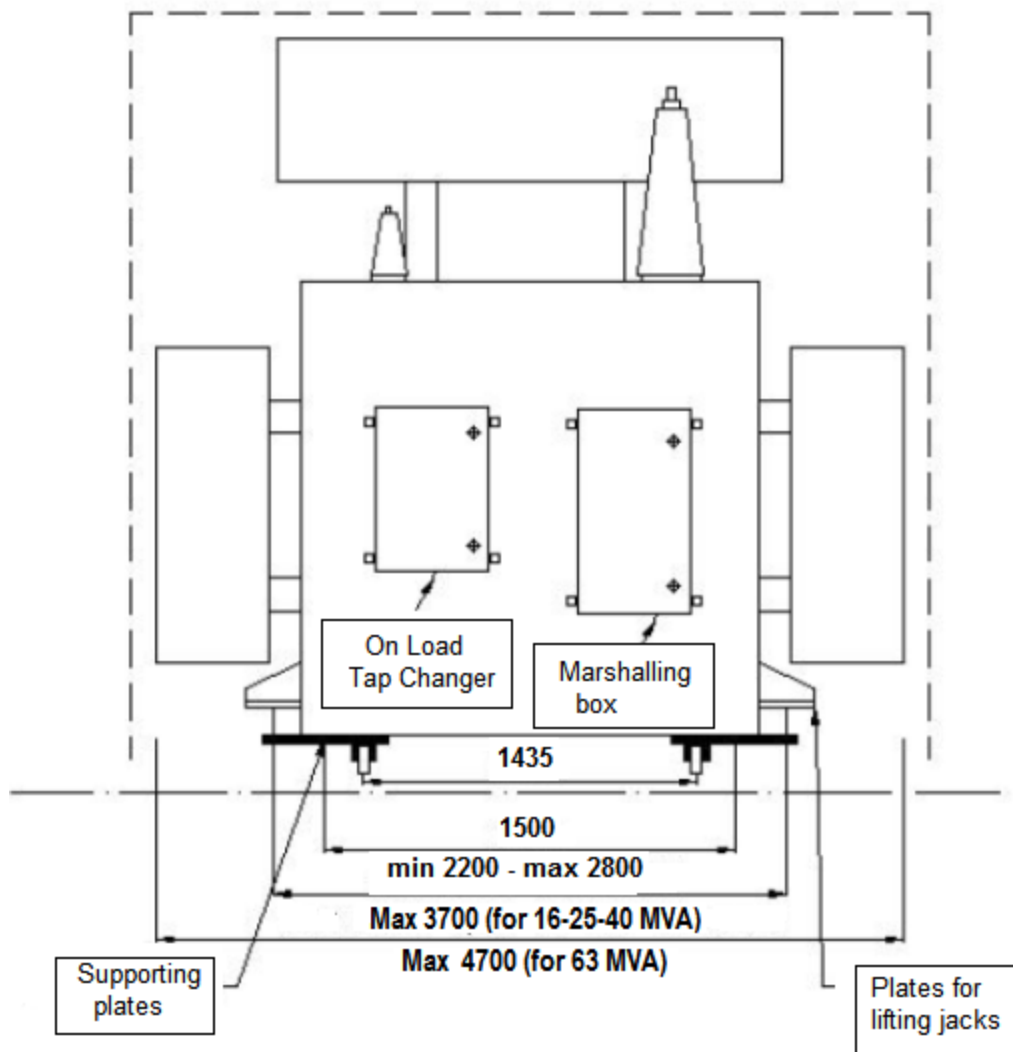
**FIGURE 2 – LATERAL VIEW FROM THE MV SIDE (AIR LINES CONNECTIONS)**



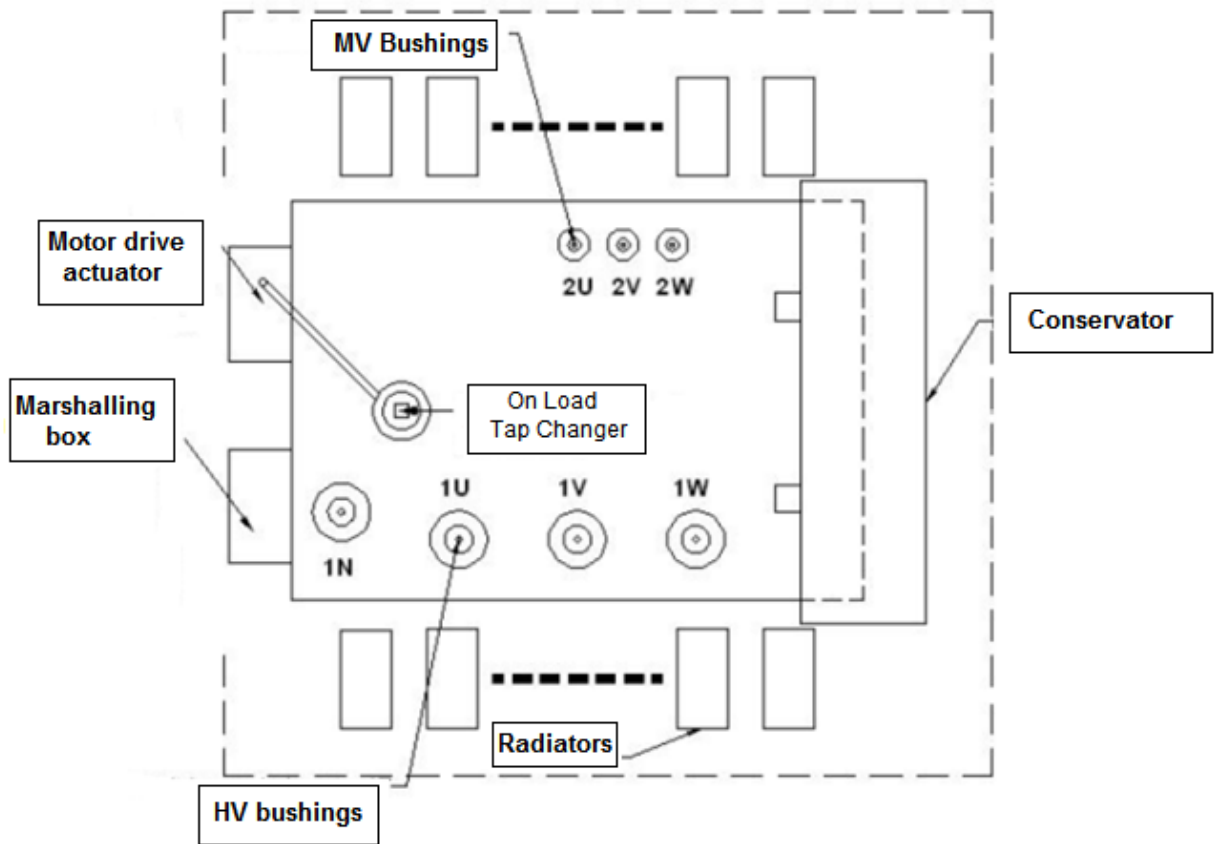

 	GLOBAL STANDARD	Page 132 of 182
	<b>POWER TRANSFORMERS</b> LOCAL SECTION ENEL DISTRIBUTIE (ROMANIA)	<b>GST002</b> Rev. 01 15/01/2014

**FIGURA 3 – OVERVIEW (FOR AIR LINES CONNECTIONS)**

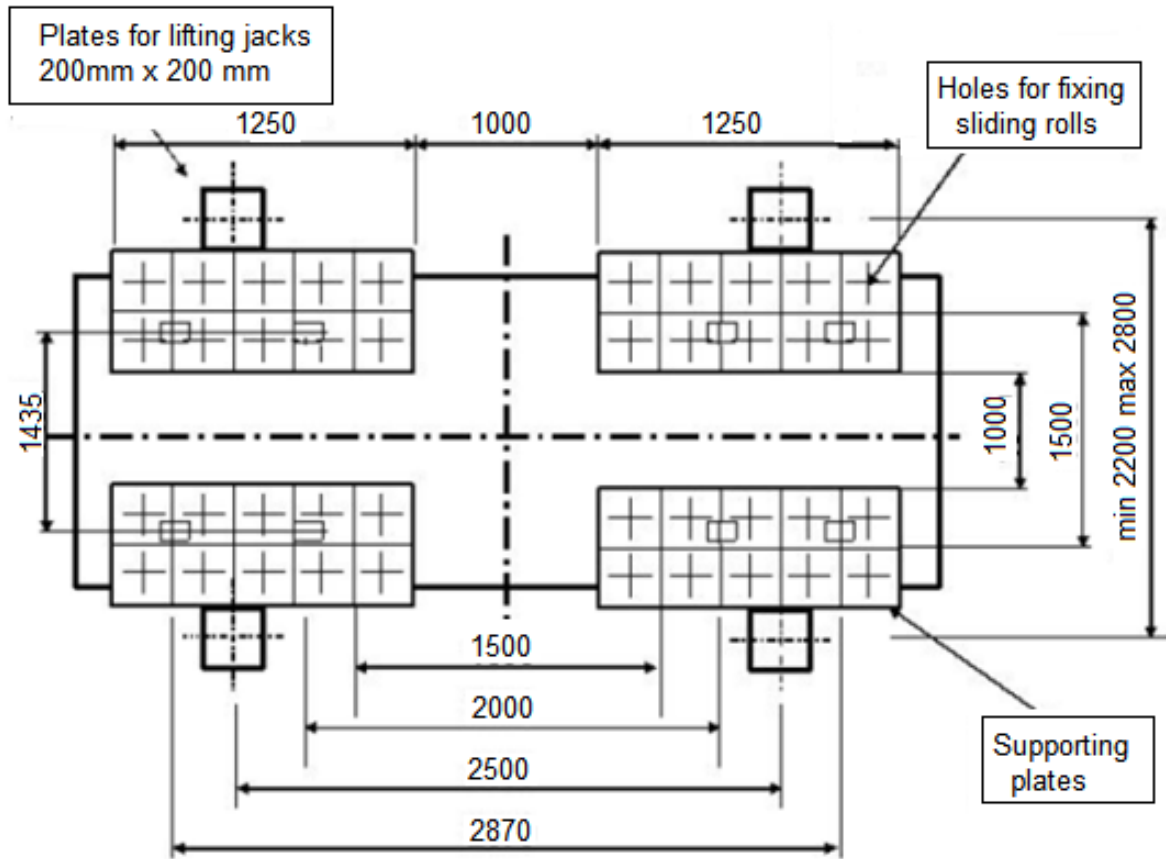
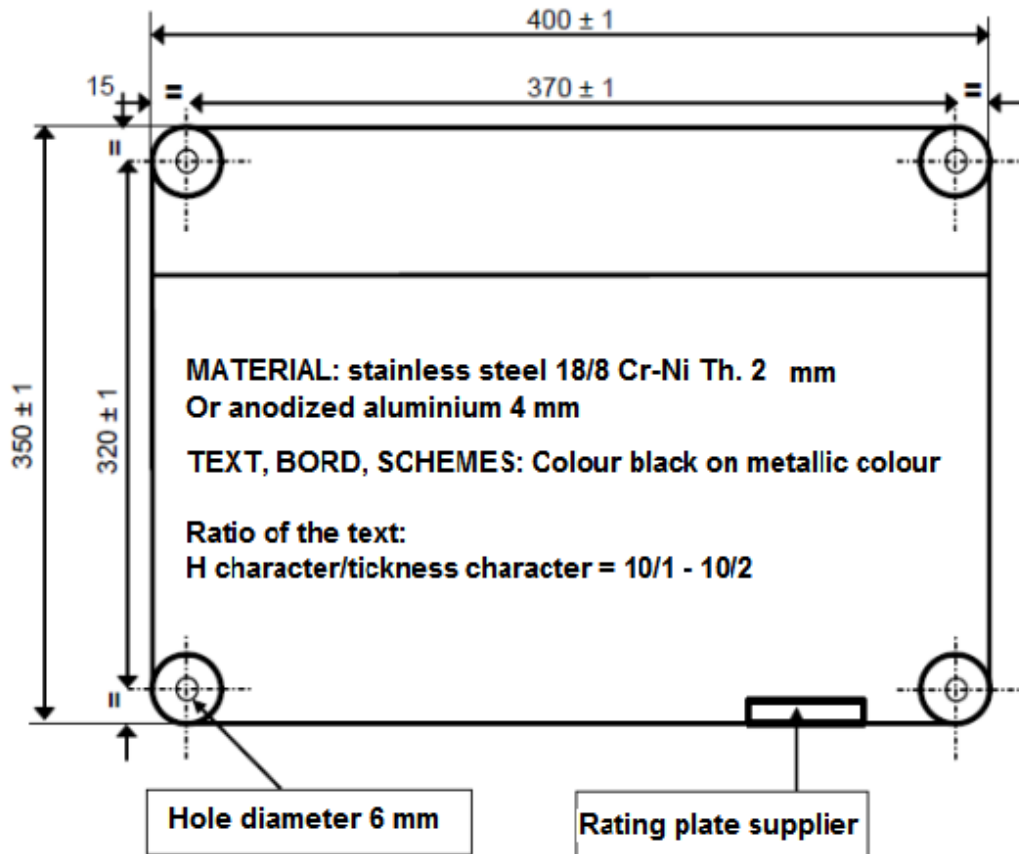

**FIGURE 4 – SUPPORTING PLATES**



	GLOBAL STANDARD	Page 134 of 182
	<b>POWER TRANSFORMERS</b> LOCAL SECTION ENEL DISTRIBUTIE (ROMANIA)	<b>GST002</b> Rev. 01 15/01/2014

**FIGURE 5 – DIMENSIONS AND CHARACTERISTICS OF THE RATING PLATES**





 	GLOBAL STANDARD	Page 135 of 182
	POWER TRANSFORMERS LOCAL SECTION ENEL DISTRIBUTIE (ROMANIA)	GST002 Rev. 01 15/01/2014

FIGURE 6: RATING PLATE FOR TRANSFORMER WITH ONE VOLTAGE LEVEL AT THE MV SIDE

**Marca si sigla Producatorului**

SR EN 60076

**TRANSFORMATOR TRIFAZAT**

Nr.  An  50Hz

SIGLA Producator  TIP

PUTERE NOMINALA  kVA

TIP ONAN PENTRU EXTERIOR  
Reglajul tensiunii pe IT de tipul  
CU SUBSTITUTIE / PRIN INVERSIUNE

Infasurare	Tensiune nominala	Curent nominal	Nivel izolare	Simbol conexiune	YnD-11
IT cu CdP	<input type="text"/>	<input type="text"/>	IA.../ND...APP...		
MT	20,8 kV	<input type="text"/>	IA...APP'...		

Zcc

<input type="text"/> %	CdP +10Priza ...../MT
<input type="text"/> %	CdP 0Priza ...../MT
<input type="text"/> %	CdP -10Priza ...../MT

MASA ULEI DECUVABILA TOTALA

<input type="text"/>	t
<input type="text"/>	t
<input type="text"/>	t

Transformatorul cu ulei si cu toate accesoriile montate poate fi ridicat si transportat  
Cuva si conservatorul adaptate la vid

Desenul depinde de tipul de reglaj folosit

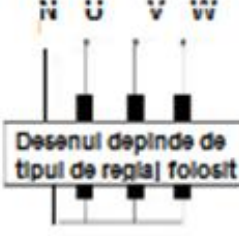

IT

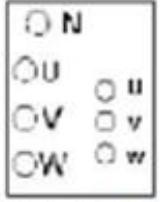

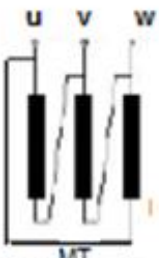

MT

INALTIMEA MINIMA A CARLIGULUI MACARALEI  m

**FIGURE 7 - RATING PLATE FOR TRANSFORMER WITH DOUBLE VOLTAGE LEVEL AT THE MV SIDE**

**Marca si sigla Producatorului**

**SR EN 60076**

**TRANSFORMATOR TRIFAZAT**

Nr.  An  50Hz

PUTERE NOMINALA  kVA

SIGLA Producator  TIP

**TIP ONAN PENTRU EXTERIOR**



Reglajul tensiunii pe IT de tipul  
CU SUBSTITUTIE / PRIN INVERSIUNE

Infasurare	Tensiune nominala	Curent nominal	Nivel izolare	Simbol conexiune	YnD-11
IT cu CdP	<input type="text"/>	<input type="text"/>	<input type="text"/>		
MT	20,8 kV	<input type="text"/>	<input type="text"/>		
	10,4 kV	<input type="text"/>	<input type="text"/>		
Zcc	<input type="text"/>	CdP +10: Priza 132.35/MT		3-4 = 20,8kV	
	<input type="text"/>	CdP + 0: Priza 115.00/MT		2U-4; 2W-3=10,4kV	
	<input type="text"/>	CdP -10: Priza 97.75/MT			

**MASA ULEI DECUVABILA TOTALA**

<input type="text"/>	t
<input type="text"/>	t
<input type="text"/>	t

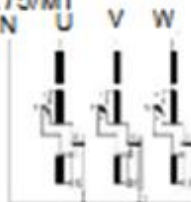
Transformatorul cu ulei si cu toate accesoriile montate poate fi ridicat si transportat  
Cuva si conservatorul adaptate la vid















IT MT

**INALTIMEA MINIMA A CARLIGULUI MACARALEI**  m



**FIGURE 8 – MARSHALLING OF TRANSFORMER SIGNALS**

The name of identification of the contact is reported in Italian languages as requested for the related drawing, the translation in English is given in the following.

1		Nivel minim ulei transformator	Alarma (99 QT)
2		Nivel minim ulei comutator de ploturi	Alarma (99 QC)
3			
4			
5		Releu Buchholz transformator	Alarma (97 T)
6			
7		Releu Buchholz transformator	Declansare (97 T)
8			
9		Temperatura maxima ulei TR	Alarma (26 Q)
10			
11		Temperatura maxima ulei TR	Declansare (26 Q)
12			
13			
14		Releu cu flux ulei comutator de ploturi	(97 C)
15			
16		Cleme rezerva	
17		Cleme rezerva	
18		Cleme rezerva	
19		Cleme rezerva	
20		Cleme rezerva	
21		Cleme rezerva	
22		Cleme rezerva	
23		Cleme rezerva	
24		Cleme rezerva	
25		Cleme rezerva	
26		Cleme rezerva	
27		Cleme rezerva	
28		Cleme rezerva	
29		Cleme rezerva	
30		Cleme rezerva	
31		Cleme rezerva	
32		Cleme rezerva	
33		Cleme rezerva	
34		Cleme rezerva	
35		Cleme rezerva	
36	}	Termosonda in fier	
37		Jug faza V	
38	}		
39		Termosonda in fier	
40		Fereastra faza V	
41	}		
42			
43		Disponibile	
44	}		
45		Alimentare incalzire si iluminare	
46		dulap de centralizare - 230Vca	
47	}	Defectiuni la incalzire si iluminare	
48		dulap de centralizare	

**FIGURE 9 – MARSHALLING OF THE AUTO-REGENERATING SILICAGEL**

(examples for two separate breathers for transformer and OLTC)

81	}	Alimentazione essiccatore trasformatore - 230 V a.c.	( 98 T )
82			
83	}	Anomalia essiccatore trasformatore	( 98 T )
84			
85	}	Riscaldamento sali trasformatore	( 98 T )
86			
87	}	Segnale analogico essiccatore trasformatore	( 98 T )
88			
89	}	Alimentazione essiccatore C.S.C. - 230 V a.c.	( 98 C )
90			
91	}	Anomalia essiccatore C.S.C.	( 98 C )
92			
93	}	Riscaldamento sali C.S.C.	( 98 C )
94			
95	}	Segnale analogico essiccatore C.S.C.	( 98 C )
96			
97	}		
98			



POWER TRANSFORMERS

LOCAL SECTION  
ENEL DISTRIBUTIE (ROMANIA)

GST002

Rev. 01

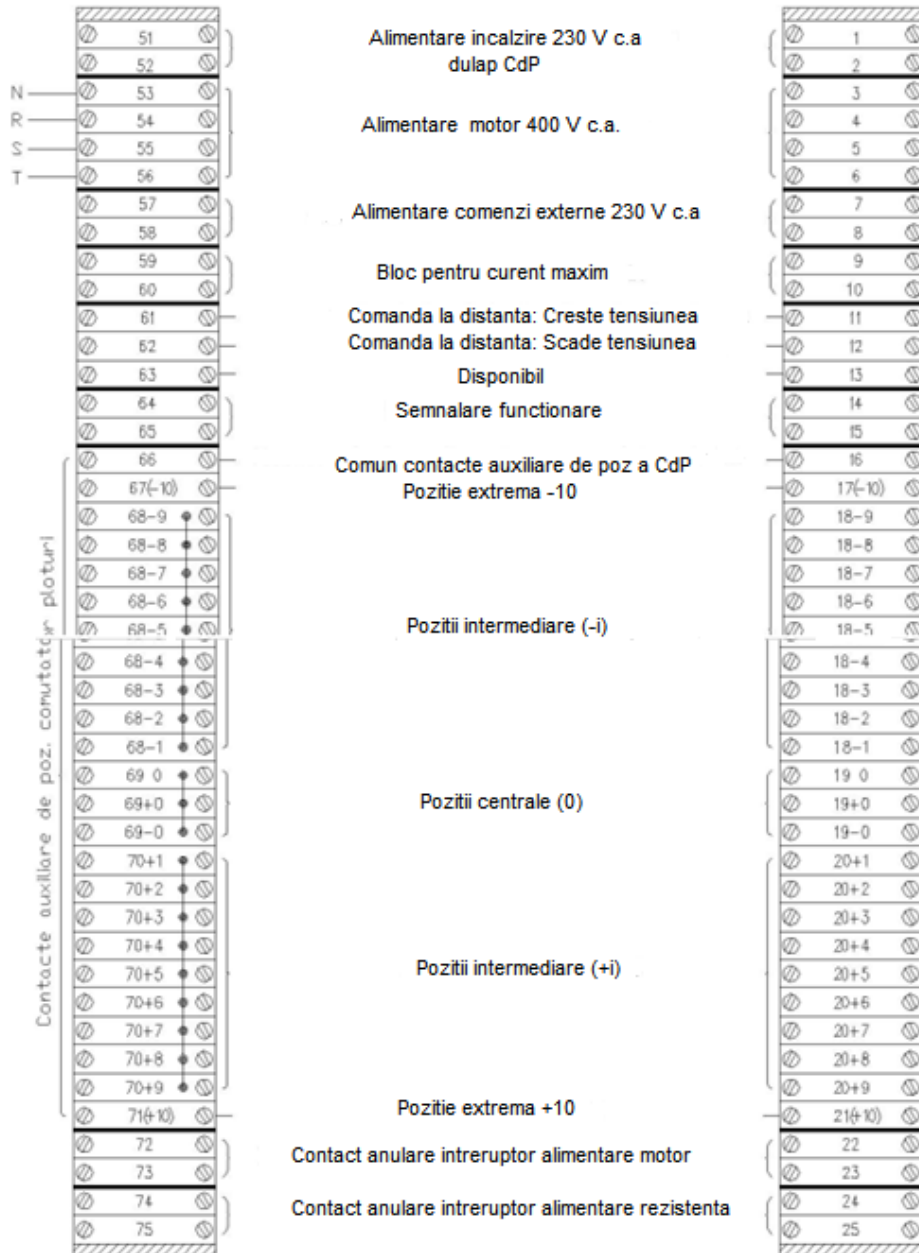

15/01/2014

FIGURE 10 – MARSHALLING OF THE OLTC SIGNALS



Sir cleme cofret  
transformator

Sir cleme dulap comanda motor  
comutator de ploturi (CdP)

 	<b>GLOBAL STANDARD</b>	Page 140 of 182
	<b>POWER TRANSFORMERS</b> <b>LOCAL SECTION</b> <b>ENEL DISTRIBUTIE (ROMANIA)</b>	<b>GST002</b> <b>Rev. 01</b> <b>15/01/2014</b>

### TRANSLATION OF THE TEXT IN FIGURE 8, 9 AND 10

Contacts	Translation	
1-2	Minimum oil level of the transformer	Alarm (99 QT)
3-4	Minimum oil level of the OLTC	Allarm (99 QC)
5-6	Buchholz relays of the transformer	Allarm (97 T)
7-8	Buchholz relays of the transformer	Trip (97 T)
9-10	Maximum oil temperature of the transformer	Alarm (26 Q)
11-12	Maximum oil temperature of the transformer	Trip (26 Q)
13-14-15	Oil flow relays of the OLTC	Trip (97 C)
16-17	Available	
18-19	Available	
20-21	Available	
22-23	Available	
24-25	Available	
26-27	Available	
28-29	Available	
30-31	Available	
32-33	Available	
34-35	Available	
36-37-38	Thermal probe of the core – yoke phase V	
39-40-41	Thermal probe of the core – window phase V	
42-43-44	Available	
45-46	230 Vac Supply of marshalling box heating and lightning	
47-48	Anomaly of marshalling box heating and lightning	
51-52	230 Vac Contro cabinet heating supply	
53-54-55-56	400 Vac Motor drive supply	
57-58	230 Vac remote signal supply	
59-60	Max current stop	
61	"Increase MV" remote signal	
62	"Decrease MV" remote signal	
63	Available	
64-65	"Motor On" signaling	
66	Common of OLTC auxiliary contact positions	
67	Extreme position -10	
68	Intermedie positions (- i)	
69	Central positions 0	
70	Intermedie positions (+ i)	
71	Extreme positions +10	
72-73	NC contact of the circuit-breaker of the motor drive supply	
74-75	NC contact of the circuit-breaker of the heating resistance supply	
81-82	230 Vac Supply of the auto-regenerating silicagels of the transformer	(98 T)
83-84	Anomaly auto-regenerating silicagels of the transformer	(98 T)
85-86-87	Warming on of auto-regenerating silicagels of the transformers	(98 T)
88-89	Analogue remote signal of auto-regenerating silicagels of the transformers	(98 T)
90-91	230 Vac Supply of the auto-regenerating silicagels of the OLTC	(98 C)
92-93	Anomaly auto-regenerating silicagels of the OLTC	(98 C)
94-95-96	Warming on of auto-regenerating silicagels of the OLTC	(98 C)
97-98	Analogue remote signal of auto-regenerating silicagels of the OLTC	(98 C)



FIGURE 11 – OIL TO AIR BUSHING

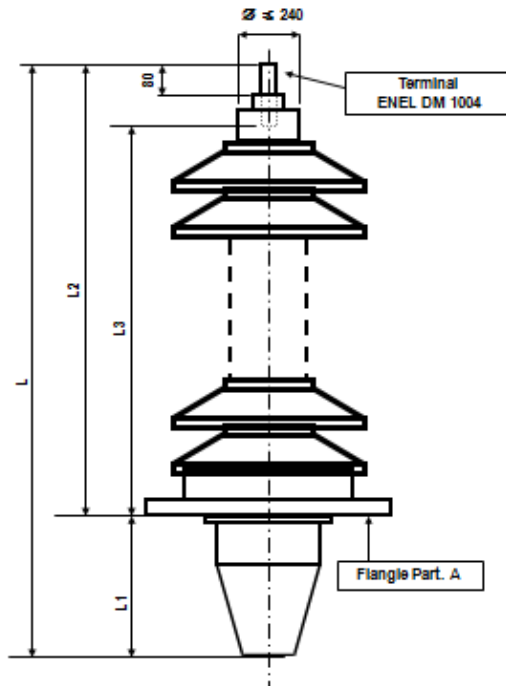

PART. A – FLANGE TRANSFORMER SIDE

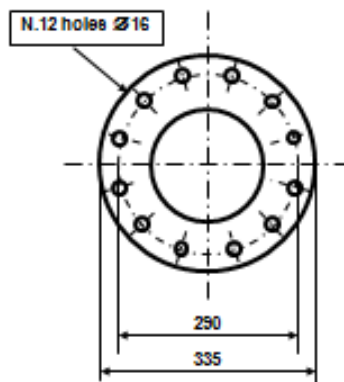
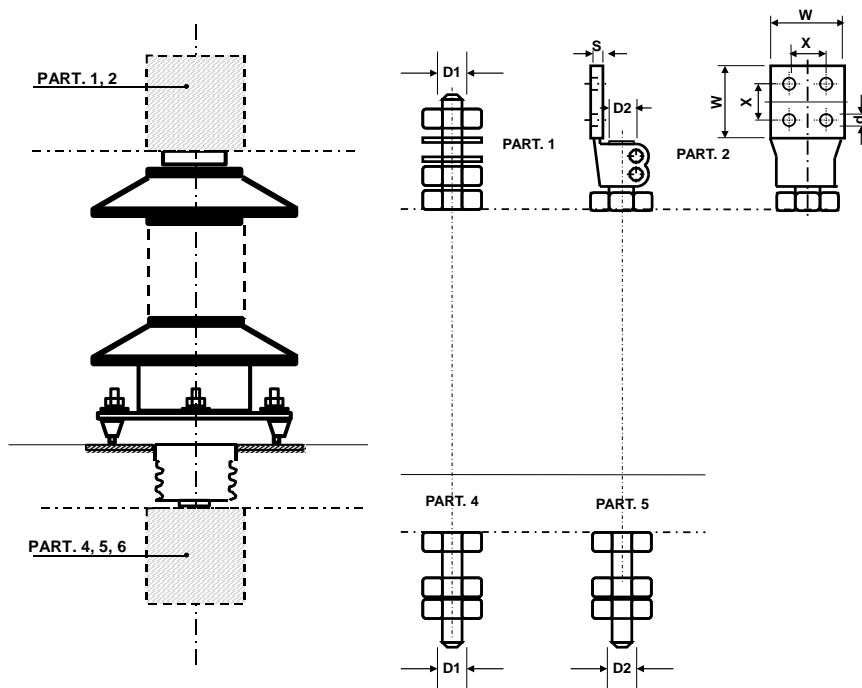



FIGURE 12 - MV BUSHING TYPES AND DIMENSIONS





Type	Classification SR EN 50180	Ir (A)	Upper interface	Lower interface	D1 (mm)	D2 (mm)	W (mm)	X (mm)	d (mm) x n° holes	S (mm)
1106/1	24-250/P3	250	Part. 1	(*)	M12	--	--	--	--	--
1106/2	24-630/P4	630	Part. 1	Part. 4	M20	--	--	--	--	--
1106/3	24-1250/P3	1250	Part. 2	Part. 5	--	M30x2	60	32	14 x 2	12
1106/4	24-2000/P3	2000	Part. 2	Part. 5	--	M42x3	100	50	18 x 4	20
1106/5	24-3150/P3	3150	Part. 2	Part. 5	--	M48x3	120	60	18 x 4	20

(\*) direct connection to the upper plug

 	GLOBAL STANDARD	Page 143 of 182
	<b>POWER TRANSFORMERS</b> LOCAL SECTION ENEL DISTRIBUZIONE (ITALY)	<b>GST002</b> Rev. 01 15/01/2014



## INDEX – LOCAL SECTION ITALY

<b>1</b>	<b>SCOPE</b> .....	<b>146</b>
<b>2</b>	<b>LIST OF COMPONENTS</b> .....	<b>146</b>
<b>3</b>	<b>REFERENCE LAWS AND STANDARDS</b> .....	<b>146</b>
<b>3.1</b>	<b>LAWS</b> .....	<b>146</b>
<b>3.2</b>	<b>INTERNATIONAL STANDARDS</b> .....	<b>146</b>
<b>3.3</b>	<b>LOCAL STANDARDS</b> .....	<b>146</b>
<b>3.4</b>	<b>OTHER RELEVANT DOCUMENTS</b> .....	<b>147</b>
<b>3.5</b>	<b>REPLACED STANDARDS</b> .....	<b>147</b>
<b>4</b>	<b>SERVICE CONDITIONS</b> .....	<b>147</b>
<b>5</b>	<b>RATINGS</b> .....	<b>147</b>
<b>5.1</b>	<b>TYPES OF TRANSFORMERS</b> .....	<b>147</b>
<b>5.2</b>	<b>NUMBER OF WINDINGS</b> .....	<b>147</b>
<b>5.3</b>	<b>NUMBER OF PHASES</b> .....	<b>147</b>
<b>5.4</b>	<b>COOLING SYSTEM</b> .....	<b>147</b>
<b>5.5</b>	<b>RATED POWER</b> .....	<b>148</b>
<b>5.6</b>	<b>RATED VOLTAGES</b> .....	<b>148</b>
<b>5.7</b>	<b>RATED FREQUENCY</b> .....	<b>148</b>
<b>5.8</b>	<b>VOLTAGE REGULATION</b> .....	<b>148</b>
5.8.1	HV Regulation.....	148
5.8.2	MV Regulation .....	148
<b>5.9</b>	<b>WINDINGS CONNECTIONS</b> .....	<b>148</b>
<b>5.10</b>	<b>INSTALLATION</b> .....	<b>148</b>
<b>5.11</b>	<b>HV AND MV NEUTRAL</b> .....	<b>148</b>
<b>5.12</b>	<b>OVER-LOAD CAPABILITY</b> .....	<b>148</b>
<b>5.13</b>	<b>BUSHINGS</b> .....	<b>148</b>
<b>5.14</b>	<b>INSULATION LEVELS</b> .....	<b>149</b>
<b>5.15</b>	<b>LOSSES AND SHORT CIRCUIT IMPEDANCES</b> .....	<b>149</b>
5.15.1	Losses penalties .....	150
5.15.2	Load loss for coarse/fine type HV regulation.....	150
5.15.3	Load loss for reversing type HV regulation .....	150
<b>5.16</b>	<b>OVER-EXCITATION CONDITIONS</b> .....	<b>151</b>
<b>5.17</b>	<b>NO-LOAD CURRENT</b> .....	<b>151</b>
<b>5.18</b>	<b>OVER-TEMPERATURE OF THE CORE</b> .....	<b>151</b>
<b>5.19</b>	<b>CAPABILITY TO WITHSTAND SHORT-CIRCUIT</b> .....	<b>151</b>
<b>5.20</b>	<b>SOUND LEVELS</b> .....	<b>151</b>
<b>5.21</b>	<b>OVERALL DIMENSIONS</b> .....	<b>151</b>
<b>5.22</b>	<b>RATING PLATES</b> .....	<b>151</b>
<b>5.23</b>	<b>TOLERANCES</b> .....	<b>151</b>
<b>6</b>	<b>DESIGN REQUIREMENTS</b> .....	<b>152</b>
<b>6.1</b>	<b>CORE AND FRAME</b> .....	<b>152</b>
<b>6.2</b>	<b>WINDINGS</b> .....	<b>152</b>
<b>6.3</b>	<b>HV AND MV NEUTRAL</b> .....	<b>152</b>
<b>6.4</b>	<b>TANK</b> .....	<b>152</b>
<b>6.5</b>	<b>INSULATING LIQUID AND MATERIAL</b> .....	<b>152</b>
<b>6.6</b>	<b>MV WIDINGS CONNECTIONS CHANGE</b> .....	<b>153</b>



 	GLOBAL STANDARD	Page 144 of 182
	<b>POWER TRANSFORMERS</b> LOCAL SECTION ENEL DISTRIBUZIONE (ITALY)	<b>GST002</b> Rev. 01 15/01/2014

<b>6.7</b>	<b>COOLING SYSTEM .....</b>	<b>153</b>
<b>6.8</b>	<b>ACCESSORIES AND AUXILIARIES .....</b>	<b>153</b>
<b>6.9</b>	<b>MARSHALLING BOX.....</b>	<b>155</b>
<b>6.10</b>	<b>PROTECTIVE PAINTING.....</b>	<b>156</b>
<b>7</b>	<b>MAIN COMPONENTS .....</b>	<b>157</b>
<b>7.1</b>	<b>BUSHING GENERAL REQUIREMENTS.....</b>	<b>157</b>
7.1.1	HV Bushings .....	157
7.1.1.1	Ratings.....	157
7.1.1.2	Design requirements .....	158
7.1.1.3	Overall dimensions .....	158
7.1.1.4	Tests.....	158
7.1.2	MV Bushings.....	159
7.1.2.1	Ratings.....	159
7.1.2.2	Design requirements .....	159
7.1.2.3	Overall dimensions .....	159
7.1.2.4	Tests.....	159
7.1.2.5	MV Plug-in bushings inside cone type .....	159
<b>7.2</b>	<b>ON LOAD TAP CHANGER .....</b>	<b>160</b>
7.2.1	Ratings.....	160
7.2.2	Design requirements .....	160
7.2.2.1	Painting.....	161
7.2.2.2	Maintenance .....	162
7.2.2.3	Functional requirements .....	162
7.2.3	Tests .....	162
<b>8</b>	<b>TESTS.....</b>	<b>162</b>
<b>8.1</b>	<b>LIST AND CLASSIFICATION OF TESTS .....</b>	<b>162</b>
8.1.1	Routine tests.....	162
8.1.2	Additional routine tests for transformers with $U_m \geq 72,5$ KV.....	162
8.1.3	Type tests .....	162
8.1.4	Special tests .....	162
8.1.5	General statement for tests .....	162
8.1.5.1	Short circuit test criteria .....	162
<b>8.2</b>	<b>TESTS DESCRIPTION.....</b>	<b>163</b>
8.2.1	Routine tests.....	163
8.2.1.13	Insulating oil tests .....	163
8.2.1.16	Active part inspection .....	164
8.2.1.17	Measurement of zero-sequence residual voltage .....	164
8.2.2	Additional routine tests for transformers with $U_m \geq 72,5$ KV.....	164
8.2.3	Type tests .....	164
8.2.3.5	Temperature rise test with zero-sequence current.....	164
8.2.3.6	Tests on the rating plates .....	165
8.2.4	Special tests .....	165
8.2.4.2	Determination of transient voltage transfer characteristics .....	165
<b>9</b>	<b>SUPPLY REQUIREMENTS .....</b>	<b>166</b>
<b>9.1</b>	<b>TRANSPORT.....</b>	<b>166</b>
<b>9.2</b>	<b>COMMISSIONING.....</b>	<b>166</b>
<b>9.3</b>	<b>DOCUMENTATION .....</b>	<b>166</b>



 	GLOBAL STANDARD	Page 145 of 182
	<b>POWER TRANSFORMERS</b> LOCAL SECTION ENEL DISTRIBUZIONE (ITALY)	<b>GST002</b> Rev. 01 15/01/2014

9.3.1	Documentation for the offer .....	166
9.3.2	Documentation for homologation, certification and approval .....	166
9.3.2.1	Not-reserved documentation (Type A) .....	166
9.3.2.2	Reserved documentation (Type B).....	166
<b>9.4</b>	<b>GUARANTY.....</b>	<b>166</b>
<b>10</b>	<b>EXCEPTIONS .....</b>	<b>166</b>
<b>11</b>	<b>FIGURES.....</b>	<b>166</b>

 	GLOBAL STANDARD	Page 146 of 182
	<b>POWER TRANSFORMERS</b> LOCAL SECTION ENEL DISTRIBUZIONE (ITALY)	<b>GST002</b> Rev. 01 15/01/2014

## 1 SCOPE

The scope of this Local Section is to integrate the Common Part in order to provide the technical standard requirements for the power transformers of Enel Distribuzione.

Each transformer is identified by the type code in the Common List with the specific rated power, rated voltages and the type of connections.

## 2 LIST OF COMPONENTS

See Common List.

## 3 REFERENCE LAWS AND STANDARDS

Here below is reported the list of reference laws and standards relevant for this document.

### 3.1 LAWS

**D.Lgs n. 81/2008** Testo unico in materia di sicurezza sul lavoro

**D.Lgs n. 52/1997 n. 52** - Classificazione, imballaggio ed etichettatura delle sostanze pericolose

**Direttiva 98/98/CE** recante venticinquesimo adeguamento al progresso tecnico della direttiva 67/548/CEE del Consiglio concernente il ravvicinamento delle disposizioni legislative, regolamentari ed amministrative relative alla classificazione, all'imballaggio e all'etichettatura delle sostanze pericolose

**Decreto legislativo 3 dicembre 2010, n. 205** recante *Disposizioni di attuazione della direttiva 2008/98/CE del Parlamento europeo e del Consiglio del 19 novembre 2008 relativa ai rifiuti.*

and subsequent modifications/integrations.

### 3.2 INTERNATIONAL STANDARDS

### 3.3 LOCAL STANDARDS

For Italy the following standards and publications are also to be taken as reference. They refer to the European versions (EN – CLC) and their country endorsement (CEI).

EN 50216(series) Power transformers and reactor fittings (from Part 1 to Part 12)

EN 50180 Bushings above 1 kV up to 36 kV and from 250 A to 3,15 kA for liquid filled Transformers



EN 50299 Oil-immersed cable connection assemblies for transformers and reactors having highest voltage for equipment  $U_m$  from 72,5 kV to 550 kV

EN 60068-3-3 Environmental testing - Parte 3: Guidance - Seismic test methods for equipments

EN 60947-7-2 Low-voltage switchgear and controlgear - Part 7: Ancillary equipment - Section 2: Protective conductor terminal blocks for copper conductors

EN 13674-1 Railway applications - Track - Rail - Part 1: Vignole railway rails 46 kg/m and above

UNI 4667 Monometri, Vacuometri, Manovacuometri – Rubinetto con attacco ½ Gas – PN 16

 	GLOBAL STANDARD	Page 147 of 182
	<b>POWER TRANSFORMERS</b> LOCAL SECTION ENEL DISTRIBUZIONE (ITALY)	<b>GST002</b> Rev. 01 15/01/2014

CEI 7-6 Requirements for checking hot galvanizing by immersion on ferrous components used in lines and electrical installations

CLC/TS 50458 Capacitance graded outdoor bushing 52 kV up to 420 kV for oil immersed transformers

### 3.4 OTHER RELEVANT DOCUMENTS

ENEL DM 1004 Attacchi a codolo per apparecchiature

ENEL DY 991 Rivestimenti protettivi di apparecchiature e macchinario elettrico

ENEL DY 2101 Prescrizioni per l'esecuzione delle prove di tipo sui rivestimenti protettivi di apparecchiature e macchinario elettrico

### 3.5 REPLACED STANDARDS

NCDT 1087 Trasformatori di Potenza AT/MT – Norma comune Enel-Endesa

DT 1088 Trasformatori di Potenza AT/MT – Norma particolare Enel

## 4 SERVICE CONDITIONS

The seismic qualification level is: AG5 - EN 60068-3-3.

The Manufacturer shall produce a report to demonstrate the Seismic qualification level required.

## 5 RATINGS

The main common transformers for Enel-Distribuzione are standardized with common rating as indicated in the following.

### 5.1 TYPES OF TRANSFORMERS

Transformers HV/MV.

### 5.2 NUMBER OF WINDINGS

Standard value is 2.

### 5.3 NUMBER OF PHASES

Standard value is 3.

### 5.4 COOLING SYSTEM

Standard system is ONAN.

	GLOBAL STANDARD	Page 148 of 182
	<b>POWER TRANSFORMERS</b> LOCAL SECTION ENEL DISTRIBUZIONE (ITALY)	<b>GST002</b> Rev. 01 15/01/2014

## 5.5 RATED POWER

Rated values are 16 MVA, 25 MVA, 40 MVA and 63 MVA

See Common List .

## 5.6 RATED VOLTAGES

Rated values for HV side are 132 kV and 150 kV.

Rated values for MV side are 20,8 KV, 15,6 kV and 20,8-10,4 kV.

See Common List .

## 5.7 RATED FREQUENCY

Rated value is 50 Hz .

## 5.8 VOLTAGE REGULATION

### 5.8.1 HV Regulation

Standard value is  $\pm 12 \times 1,25\%$ .

### 5.8.2 MV Regulation

It is prescribed for double secondary voltage.

## 5.9 WINDINGS CONNECTIONS

Standard connections is Yyn0.

## 5.10 INSTALLATION

Outdoor.

## 5.11 HV AND MV NEUTRAL

The MV neutral connection shall be suitable for the connection of the neutral point with the Petersen coil. Specific prescriptions are given in the clauses of the design requirements.



## 5.12 OVER-LOAD CAPABILITY

## 5.13 BUSHINGS

The bushings shall be selected according to the transformer rated power, the rated voltage and the interfaces in the substation related to the transformers code type in accordance with Table 1.

The type of HV and MV bushing interfaces with the network (O/A – O/O – O/S) for each transformers type code are given in the Common List and the main characteristics of the bushing types are in the relevant sub-clauses of 7.1.

If optionally requested the MV bushings shall be of plug-in type as specified in 7.1.2.5.

 	GLOBAL STANDARD	Page 149 of 182
	<b>POWER TRANSFORMERS</b> LOCAL SECTION ENEL DISTRIBUZIONE (ITALY)	<b>GST002</b> Rev. 01 15/01/2014

The bushings shall be marked as indicated in the following:

- HV: 1U, 1V, 1W
- MV: 2U, 2V, 2W and 2N

**TABLE 1 - MV BUSHINGS TYPE**

Rated Power (MVA)	MV Bushing type			HV Bushing type	
	MV Rated Voltage (kV)			Connection type	
	15,6	20,8	20,8-10,4	Overhead Line	SF <sub>6</sub> / Cable
16	DJ 1106/3	DJ 1106/3	DJ 1106/4	DJ 1104/1 (Ur 132 kV) DJ 1104/2 (Ur 150kV)	DJ 1104/3
25	DJ 1106/4	DJ 1106/3	DJ 1106/4		
40	DJ 1106/4	DJ 1106/4	DJ 1106/5		
63	DJ 1106/5	DJ 1106/5	--		

#### 5.14 INSULATION LEVELS

The prescribed insulation levels are indicated in Table 2

**TABLE 2 - INSULATION LEVELS**

Rated Voltage U <sub>r</sub> (kV)	Highest Voltage for equipment U <sub>m</sub> (kV)	Tests		
		Lightning Impulse LI (kV)	Separata Source AC (kV)	Short Duration AC ACSD (kV)
150	170	650	275	275
132	145	550	230	230
20,8	24	125	50	resulting
15,6	24	125	50	resulting
10,4	24	125	50	resulting

#### 5.15 LOSSES AND SHORT CIRCUIT IMPEDANCES



The losses value shall be in compliance with the PEI (Peak Efficiency Index) values reported in the Annex D for each corresponding rated power.

The prescribed short circuit impedances are also given in the Table 3.

**TABLE 3 - LOSSES AND SHORT CIRCUIT IMPEDANCES**

Rated Power (MVA)	No-Load Losses (NLL) (%)	Load Losses (LL) (%)	Short circuit impedance with the tap changer positioned on: <sup>(1)</sup>		
			Min. tap (%)	Central tap (%)	Max. tap (%)
16	PEI	PEI	12,2	13	14,1
25	PEI	PEI	13,7	14,6	15,8
40	PEI	PEI	14,6	15,5	16,8
63	PEI	PEI	21,2	22,5	24,2

<sup>(1)</sup> The above prescribed values of short circuit impedance are sufficiently high to take into account that the HV regulation could be either of the reversing type or coarse-fine type.

 	GLOBAL STANDARD	Page 150 of 182
	<b>POWER TRANSFORMERS</b> LOCAL SECTION ENEL DISTRIBUZIONE (ITALY)	<b>GST002</b> Rev. 01 15/01/2014

PEI values at rated voltage position has to be respected without any tolerances and moreover the single loss value shall not be higher than the below indicated values with the tolerances reported in the relevant clause.

- 16 MVA: NLL 12 KW – LL 88 kW
- 25 MVA: NLL 16 KW – LL 122 kW
- 40 MVA: NLL 23 KW – LL 186 kW
- 63 MVA: NLL 32 KW – LL 282 kW

### RESIDUAL ZERO-SEQUENCE IMPEDANCE

The short circuit impedances and related voltage drops shall not affect significantly the network parameters monitored by the protection and network control systems to ensure their correct functioning with the MV neutral grounded through Petersen coil.

Such requirement is verified by the conventional test of the residual zero-sequence impedance (three times the zero-sequence impedance) of the MV side of the transformer under rated power supply, as reported in the chapter relevant to the tests.

The residual zero-sequence impedance values shall be:

- For 16-25 MVA transformers:  $\leq 0,5\%$  of the MV rated single phase voltage (ex  $15,6/\sqrt{3}$  or  $20,8/\sqrt{3}$ )
- For 40 MVA transformers:  $\leq 0,6\%$  of the MV rated single phase voltage
- For 63 MVA transformers:  $\leq 0,8\%$  of the MV rated single phase voltage

In case of transformer with double voltage level on the MV side, it shall be taken as reference  $20,8/\sqrt{3}$  kV.

#### 5.15.1 Losses penalties

In case losses exceed the maximum values prescribed beyond the tolerances of 5.23, the following penalty rates apply part exceeding the maximum values prescribed.

- A = 3500 €/KW
- B = 1600 €/KW

#### 5.15.2 Load loss for coarse/fine type HV regulation

In case of coarse-fine type on-load tap changer, the load losses are referred to the condition with the tap changer positioned on the central tap, in such a way that the “coarse” regulation is connected while the “fine” regulation is disconnected.

In the condition of the tap-changer is positioned on the central tap, with the “rough” regulation disconnected while the “fine” regulation connected, the prescribed value is higher by the 5%.



#### 5.15.3 Load loss for reversing type HV regulation

In case of inversion-type on-load tap changer, the load losses are determined with the following equation:

$$P_c = \frac{2 \cdot P_1 + P_2 + P_3}{4}$$

Where:

- $P_1$  = load losses measured with the on-load tap changer positioned on the central tap
- $P_2$  = load losses measured with the on-load tap changer positioned on the minimal tap
- $P_3$  = load losses measured with the on-load tap changer positioned on the maximal tap

 	GLOBAL STANDARD	Page 151 of 182
	<b>POWER TRANSFORMERS</b> LOCAL SECTION ENEL DISTRIBUZIONE (ITALY)	<b>GST002</b> Rev. 01 15/01/2014

## 5.16 OVER-EXCITATION CONDITIONS

## 5.17 NO-LOAD CURRENT

## 5.18 OVER-TEMPERATURE OF THE CORE

For transformers with rated power of 63 MVA or larger, the surface over-temperature of the core shall not exceed 75 °C.

## 5.19 CAPABILITY TO WITHSTAND SHORT-CIRCUIT

## 5.20 SOUND LEVELS

The prescribed sound power level is given in the following Table 5.

**TABLE 5 - SOUND POWER LEVEL**

Rated Power (MVA)	Sound Power Level dB(A)
16	67
25	
40	70
63	74

## 5.21 OVERALL DIMENSIONS

The dimensions and the position of the main accessories are shown in the Figures listed below.

- Transformers with Oil/Air HV bushings: Figures 1, 2 and 3
- Transformers with Oil/SF<sub>6</sub> or Oil/ Oil HV bushings: Figures 4, 5 and 6
- Supporting plates: Figure 7

## 5.22 RATING PLATES

The rating plate dimensions, together with the models, are reported, for both transformers with single and double level of MV voltage in Figures 8, 9 and 10.

## 5.23 TOLERANCES

The admitted tolerances on the prescribed values are the ones of EN 60076-1.

With reference to the prescribed losses values, a free zone within which no penalties are applied is defined as below:

- No tolerance is admitted on the PEI values.
- + 5% for the no-load loss values indicated
- + 2.5% for the load loss values indicated
- No tolerance is admitted on the sound power level prescribed.

	GLOBAL STANDARD	Page 152 of 182
	<b>POWER TRANSFORMERS</b> LOCAL SECTION ENEL DISTRIBUZIONE (ITALY)	<b>GST002</b> Rev. 01 15/01/2014

## 6 DESIGN REQUIREMENTS

### 6.1 CORE AND FRAME

### 6.2 WINDINGS

### 6.3 HV AND MV NEUTRAL

The MV neutral of the transformer shall be able to withstand the current values indicated in the following Table 6 for one minute long in such a way that the maximum over-temperature of the tank (usually detectable on the middle of the tank itself) will not exceed 70°K.

The section of the neutral conductor shall be the same of the phase conductors.

**TABLE 6 - NEUTRAL CURRENT**

Rated power [MVA]	Neutral current [A]
16	400
25	720
40	920
63	1120

Note: the scope of this prescription, and of the relevant test, is the verification of the maximum over-temperature reached by the tank during the application of the above indicated neutral current in order to prevent generation of gas bubbling in the oil and degradation of the painting of the tank.

### 6.4 TANK

The tank shall be provided with the following parts, located as shown in the Figures of the overall dimensions:



- Supporting plates on the base for the lay down of the transformer, provided with holed bolts to allow, if necessary, the installation of wheels
- Shelf plates on the base for the lifting of the transformer through jacks.

### 6.5 INSULATING LIQUID AND MATERIAL

The insulating liquid shall be mineral oil uninhibited, identified with the U letter without any anti-oxidant additive, accordingly to IEC 60296.

For the classification of dangerous oil, the Italian reference law is D.Lgs n.52/1997 and following modifications. The specific risk for oils classified as dangerous are identified by the “risks statements R45, R46 and R49”, listed in D.M. 28/04/1997 and following modifications.



 	GLOBAL STANDARD	Page 153 of 182
	<b>POWER TRANSFORMERS</b> LOCAL SECTION ENEL DISTRIBUZIONE (ITALY)	<b>GST002</b> Rev. 01 15/01/2014

## 6.6 MV WIDINGS CONNECTIONS CHANGE

For transformer with double voltage level of the MV windings (i.e. 20,8-10,4 kV), the voltage changing shall be made by an in-tank bar connection located under the tank cover, accessible through a specific windows, after lowering of the oil level.

## 6.7 COOLING SYSTEM

The cooling system of the transformers shall be ONAN, made by radiators directly connected to the tank through flanges with the interposition of proper butterfly valves as prescribed in 6.8 in order to remove radiators without emptying the oil from the tank.

## 6.8 ACCESSORIES AND AUXILIARIES

The mechanical and electrical accessories shall be compliant with CEI EN 50216, unless otherwise specified.

The screws for the couplings among the different components shall be of stainless steel or hot galvanized.

The cases of all the devices shall be IP 55 accordingly to CEI EN 60529, unless otherwise specified.

Each transformer shall be provided with the accessories specified in the following.

- 1) **Conservator**, adapt to compensate the oil volume variation in the range  $- 25\text{ }^{\circ}\text{C}$ ;  $+ 90\text{ }^{\circ}\text{C}$ . The conservator shall have two compartments. The main for the transformer and a second appropriate to be used for the oil of the on-load tap changer. The oils in the two compartments shall be kept separated.

Each of the two compartments shall be provided with:



- 1a) **Oil level indicator** with the levels  $- 20\text{ }^{\circ}\text{C}$ ,  $+ 20\text{ }^{\circ}\text{C}$ ,  $+ 85\text{ }^{\circ}\text{C}$  and electric contacts for the minimum level alarms
- 1b) **Tap for filling the oil**
- 1c) **Tap for draining the oil**
- 1d) **Window for the inspection**
- 1e) **Piping system for the dehydrating breather connections**

- 2) **Radiators** in compliance with EN 50216-6 and moreover:
  - Able to withstand vacuum conditions;
  - Painted with the same protective cover of the tank.

The coupling of the radiators and the tank shall be made in order to ensure the metallic continuity.

- 3) **Two butterfly valves for each radiator**, in compliance with EN 50216-8, on the connection pipes on the tank side.
- 4) **Blind flange with washer** for locking the butterfly valves of the previous item.
- 5) **Dehydrating breathers** with hygroscopic substances self-regenerating (maintenance free), one for each compartment, mounted at head height.

The two dehydrating breathers can be replaced by only one device, provided that the dimensioning is made taking into account the total oil content. In this case the two separated compartments in the



 	GLOBAL STANDARD	Page 154 of 182
	<b>POWER TRANSFORMERS</b> LOCAL SECTION ENEL DISTRIBUZIONE (ITALY)	<b>GST002</b> Rev. 01 15/01/2014

conservator shall be however maintained, and they shall be connected to the de-hydrating breather trough a unique pipe (without interception valves).

Note: for the 63 MVA transformers, which contain larger amount of oil than the smaller transformers, generally the de-hydrating breather Suppliers recommend the use of more dimensioned devices or the use of two devices.

The oil de-hydrating devices shall be cobalt free, accordingly to EU Directive UE 98/98/CE.

- 6) **Window for the inspection**, at least one appropriately protected against accidental impacts, to be mounted on the cover tank for checking the oil treatment.
- 7) **One bronze tap for oil sampling**, with spherical moving element, female plug-in Gj 1/2" UNI 4667, provided with male cap T9 - 1/2" gas with chain; such a device shall be mounted no lower than 60 mm from the bottom.
- 8) **Two bronze taps for oil treatment**, with spherical moving element, male plug-in Gc 1" 1/2 gas UNI 4667, provided with nut caps T1 - 1" 1/2 gas with chain. The two taps shall be mounted close to each other, on the lower part of the tank, and shall be connected through pipelines to two diametrically opposite zones of the tank in order to allow an optimal re-circulation of the oil. The tap mounted on the lower part shall be used also for the draining of the oil.
- 9) **Two taps for oil treatment of the diverter switch compartment of the OLTC.**
- 10) **One bronze tap for the vacuum pump**, with spherical moving element, with male plug-in Gc 1" 1/2 gas UNI 4667, provided with nut caps T1 - 1" 1/2 gas with chain.
- 11) **Three thermometer pockets** for the temperature measurement of the top oil, accordingly to EN 50216-4 type- A1, one of which will be used for the probe of the quadrant thermometer and the others will remain available.
- 12) **One quadrant thermometer** complaint with EN 50216-11 for the oil temperature measurement, elastically fixed at the tank, provided with settable electric contacts for the maximum temperature alarm, with independent electric circuits. The following thresholds shall be set:
  - Alarm threshold: 95 °C
  - Tripping threshold: 105 °C
- 13) **The hooks for lifting** the completely assembled transformer, the extractable part (cover and active part) and for the conservator.
- 14) **Hooks for horizontal movement** of transformer to the two orthogonal directions, to be positioned at the bottom of the transformer close to the base.
- 15) **Two grounding terminals** on the tank, each of which consisting of a plate with dimensions 90x50x15 mm with two threaded holes M16, positioned at the base of the tank (approximately at the middle of the longest sides) and shall be marked with two name plates with the grounding symbol (black symbol on a yellow background).
- 16) **Interception valves of the butterfly type**, to be mounted both upstream and downstream of each of the relays required (items 18, 19, 26 and 28).
- 17) **Flanged pipelines trunks** in case of relays removal (items 18, 19, 26 and 28).

 	GLOBAL STANDARD	Page 155 of 182
	<b>POWER TRANSFORMERS</b> LOCAL SECTION ENEL DISTRIBUZIONE (ITALY)	<b>GST002</b> Rev. 01 15/01/2014

- 18) **One Buchholz relays**, mounted on the pipeline which connects the conservator and the tank, with two with independent contacts (alarm/tripping), related electrical control circuit. An additional device for the gas storage shall be provided and mounted at head height on the tank.

The set up of the tripping contacts for oil flux shall be 1,5 m/s, if not otherwise agreed.

- 19) **Oil flow relays for OLTC**, mounted in the pipeline which connects the compartment of the diverter switch of the OLTC and the relevant conservator compartment.

- 20) **Two thermal resistances for the surface core temperature measurement**, of platinum of 100 ohms at 0° C, with the temperature coefficient  $3,85 \times 10^{-3} \text{ }^\circ\text{C}^{-1}$ , and with shielded terminals.

One thermal resistance shall be mounted at the central column in correspondence to the cross with the top yoke. The other shall be mounted on the cover of the top yoke, in correspondence to the central column and inserted into a cooling pipeline of the core, if existing.

The relevant wires shall be brought to the marshalling box (for possible core over-temperature monitoring).

- 21) **Over pressure valves**, at least one to prevent pressure increasing inside the tank in case of internal fault.
- 22) **Specific fall arrest system for the operator**, if specifically requested
- 23) **Adjustable sliding rolls** in compliance with EN 13674-1, if specifically requested.

For HV connection with GIS or cable, the following accessories shall be also provided:

- 24) **Three compensators** for GIS or oil cable box.
- 25) **Four plates and relevant supports** for the GIL (Gas Insulated Transmission Line) or cable boxes
- 26) **Buchholz gas relays** mounted on the pipe connecting the conservator and the relief junctions of the bottom flange of the oil-SF<sub>6</sub> or oil-oil bushings.

For HV connections with cable, moreover the following accessories shall be also provided:

- 27) **Three oil cable boxes** compliant with CEI EN 50299.
- 28) **Buchholz gas relays** mounted on the pipe connecting the cable boxes and the conservator.

## 6.9 MARSHALLING BOX

All the electric circuits of the auxiliaries shall be attested to the marshalling box.

The identification of the connectors shall be in Local Language as reported in the attached Figures (translation is also given attached).

The marshalling box shall be installed on the tank in the shorter side opposite to the MV bushings.

The box shall have an IP 55 protection degree according to CEI EN 60529 and shall be provided with appropriate door, laterally hinged, to be opened with either special key or removable door handle.

The box shall be realized with either stainless steel sheets or hot zinc-coated (CEI 7-6 Standard) or with metallic not subject to corrosion. The box shall be painted with colour 7031 of the RAL F2 scale by using painting cycles complaint with DY 991.

	GLOBAL STANDARD	Page 156 of 182
	<b>POWER TRANSFORMERS</b> LOCAL SECTION ENEL DISTRIBUZIONE (ITALY)	<b>GST002</b> Rev. 01 15/01/2014

The box shall contain:

- 1) **Lamp and single phase sock 230 V - 10 A**, inserted in the warming circuit.
- 2) **Heating resistances** - One for the removal of the moisture always active and a second one activated by thermostat and protected by an automatic circuit breaker with NC contact provided in the marshalling box.
- 3) **Marshallings** detailed in Figures 11, 12 and 13.
- 4) **Earth collector** consisting of a copper plate 25 x 3 mm<sup>2</sup> for the grounding of all the metallic parts and of the cable shields.

All connections wires shall have appropriate sections both with regard to the nominal operating current and the short circuit current (4,5 kA) of the power supply. All the wires conveying signals and to the actuations shall be realized with appropriate section conductors, in any case not smaller than 1,5 mm<sup>2</sup>.

Wirings inside the cabinet shall be “not fire not-spreading”, with insulation level  $U_0/U = 450/750$  V. At the terminals of the flexible conductors shall be applied compressed pre-insulated terminals and these terminals shall be identifiable with appropriate marks and/or indications.

All the wires for the connection between the marshalling box cabinet and the devices (apparatuses/auxiliaries) mounted on the transformer shall be laid into rigid steel pipelines; only terminals/trunks wires entering inside the devices and the cabinet could be laid, alternatively, into flexible pipelines. The flexible pipelines, withstanding to accidental impacts and crushings and the relevant screws, shall be made by stainless material.

The supply voltage shall be:

- for the warming circuit 230 V ± 10%, 50 Hz
- For the signalling and protection circuits 110 V +10% -15% c.c.

The marshalling installed inside the box shall be of the modular type and structured as in the following.

- Marshalling box for the transformer: Figures 11 and 12
- Marshalling box for the on-load tap changer: Figure 13

The clamps shall be at indirect tightening, suitable both rigid and flexible wires of section up to 4 mm<sup>2</sup>, compliant with CEI EN 60947-7-2 and mounted on appropriate metallic support.



The clamps shall be provided with appropriate name plates reporting the marks in compliance with the above mentioned Figure 11 and Figure 12.

The marshalling boxes and the eventual pipelines of the conductors shall be mounted in such a way that to facilitate the wirings of the conductors. In particular, between the gland plane and the marshalling boxes shall be left appropriate distances in order to facilitate the stripping of the cable and the connection of the cable shields to the earthing collector.

## 6.10 PROTECTIVE PAINTING

Painting cycles for pollution level “High or Very high”, can be proposed by the transformer Supplier and approved by ENEL.

Unless otherwise agreed, Enel Distribuzione technical specifications DY 991/1 and DY 2101 apply.

 	GLOBAL STANDARD	Page 157 of 182
	<b>POWER TRANSFORMERS</b> LOCAL SECTION ENEL DISTRIBUZIONE (ITALY)	<b>GST002</b> Rev. 01 15/01/2014

The colour of the final painted layer shall be blue grey RAL 7031.

In the Enel specification DY 991 the preparation modes of the surfaces to protect are indicated.

The internal surfaces of the transformer (including the conservator) shall be protected with the painting withstanding the hot oil (maximal temperature 110°C).

## 7 MAIN COMPONENTS

### 7.1 BUSHING GENERAL REQUIREMENTS

The oil/air bushings HV and MV shall be of polymeric type.

#### 7.1.1 HV Bushings

##### 7.1.1.1 Ratings

The interchangeability of the bushings shall be accordingly to EN CLC/TS 50458.

The main characteristics of the bushings are reported in the following Table 7.

**TABLE 7 – HV BUSHINGS CLASSIFICATION**

Type of Bushing		O/A	O/A	O/S	O/O
<b>Enel Code</b>		<b>DJ 1104/1</b>	<b>DJ 1104/2</b>	<b>DJ 1104/3</b>	
<b>Drawings and interfaces</b>		Fig.14 + Part.A		Fig.15 + Part. A-B-C-D-E	
Dimensions: L, L1, L2, L3, L4		(*)	(*)	(*) (**)	
Designation accordingly to CEI CLC/TS 50458		NRUE0	NRUE0	OTXE0	
<b>Ratings</b>					
Rated voltage (Ur)	(kV)	145	170	170	
Rated phase-to-ground voltage	(kV)	145/√3	170/√3	170/√3	
Rated frequency	(Hz)	50	50	50	
Power frequency withstand voltage	(kV)	230	275	275	
Lightning impulse withstand voltage	(kV) peak	550	650	650	
Rated current (Ir)	(A)	400	400	400	
Rated short duration thermal current (I <sub>th</sub> ) for 2s	(kA)	10	10	10	
Dynamic rated current (I <sub>d</sub> )	(kA) peak	25	25	25	
Cantilever test	(N)	1250	1250	2400	
Allowable inclination		≤ 30°	≤ 30°	--	--
Minimum pollution level SPS Class (IEC 60815)		D - Heavy	D - Heavy	--	--
RUSCD	(mm/kV)	43,3	43,3	--	--
Creepage distance	(mm)	3625	4250	--	--
<b>Operating conditions:</b> accordingly to the prescriptions of the transformer and in compliance with IEC 60137					
(*) Under the Supplier responsibility in accordance to the dimensions specified for the transformer					
(**) The Supplier shall verify the interfaces of the transformer with the substation in order to ensure the proper connection (if necessary, the Supplier shall provide proper junctions)					

	GLOBAL STANDARD	Page 158 of 182
	<b>POWER TRANSFORMERS</b> LOCAL SECTION ENEL DISTRIBUZIONE (ITALY)	<b>GST002</b> Rev. 01 15/01/2014

### 7.1.1.2 Design requirements

The Oil/Air bushings shall be of polymeric type.

The HV terminals shall be complaint with Enel prescription DM1004.

Metallic parts shall be in aluminium alloy, stainless steel, or hot galvanized in compliance with CEI 7-6.

Each bushing shall be provided with the following accessories:

- 1) **Power factor tap** for measurement of the capacitance-to-ground. The Supplier shall provide drawings for the correct usage of the tap and for the inspections.
- 2) **Pressure relief cap** of 1/2" gas.
- 3) **Compensator for the oil volume variation**
- 4) **Oil level indicator**, for the oil-air bushing type
- 5) **Oil draining tap** for oil spilling for dissolved analysis purposes
- 6) **Pressure gauge** with interception valve for the detection of abnormal pressure inside the bushing, for type-2 and type-3 only (Oil/SF<sub>6</sub> and Oil/Oil type bushings)
- 7) **Hooks** for lifting the bushing

The accessories enlisted in the items 1-2-5-6-7 shall be mounted on the flange;

The minimal set of requirements for the electric contacts of the oil under/over pressure alarm of the pressure gauge, which shall be normally opened, are indicated in the following Table.

**TABLE 8 – REQUIREMENTS FOR ELECTRIC CONTACTS**

Rated Voltage	100 ÷ 140 Vdc	230 Vac
Rated Current	2 A	2 A
Power frequency insulation to ground	2.000 V	2.000 V
Power frequency insulation between opened contacts	1.000 V	1.000 V
Breaking Capacity referred to 100.000 switches	250 W – L/R = 40 ms	400 VA – cos φ > 0,5

### 7.1.1.3 Overall dimensions

The dimensions and the interfaces for the connection with HV un-covered overhead lines are specified in Figure 14.

The dimensions and the interfaces for the connection with SF<sub>6</sub> and with cable termination boxes are defined in Figure 15.

### 7.1.1.4 Tests

The following additional test are required

#### **Verification of the proper functioning of the pressure gauge (if any)**

To be performed by simulating the activation/intervention conditions. The insulation to ground shall be tested at 2 kV, power frequency, 60 s. No discharge or perforations shall occur.

	GLOBAL STANDARD	Page 159 of 182
	<b>POWER TRANSFORMERS</b> LOCAL SECTION ENEL DISTRIBUZIONE (ITALY)	<b>GST002</b> Rev. 01 15/01/2014

### Verification of the protective coating

It shall be verified that the protective coating is adequate. In case of zinc-coated metallic parts, the coat layer shall be verified with the magnetic method accordingly to EN ISO 2178.

#### 7.1.2 MV Bushings

The bushings shall be compliant with CEI EN 50180.

##### 7.1.2.1 Ratings

##### 7.1.2.2 Design requirements

The bushings shall be of polymeric type.

##### 7.1.2.3 Overall dimensions

Dimension and typologies are reported in Figure 16.

##### 7.1.2.4 Tests

##### 7.1.2.5 MV Plug-in bushings inside cone type

If specifically requested Medium Voltage plug-in bushings shall be directly installed by the transformer Manufacturer in place of the Oil/Air bushings.

The transformer Manufacturer shall supply the plug-in bushings in accordance to IEC 60137 and EN 50180 and shall provide the documentation together with the transformer documentation as prescribed at the point 9.3 of the Global Standard GST002.

The plug-in bushings can be requested with the following connections solutions:

- a) Solution with two plug-in per phase and one plug-in for neutral terminals
 

Each single bushing to be used for the phases shall have the following ratings and characteristics:  
 $U_m \geq 24$  kV;  $I_n \geq 2.000$  A; two plug-in terminals inner-cone type compliant with CEI EN 50180, clause 4.7.2 – interface: 3, with insulating cup usable also with the transformer in operation.

The bushing to be used for the neutral shall have the following ratings and characteristics:  
 $U_m \geq 24$  kV;  $I_n \geq 400$  A; two plug-in terminals inner-cone type compliant with CEI EN 50180, clause 4.7.2 – interface: 1, with insulating cup usable also with the transformer in operation.
- b) Solution with four plug-in per phase and one plug-in for neutral terminals
 

Each single bushing to be used for the phases shall have the following ratings and characteristics:  
 $U_m \geq 24$  kV;  $I_n \geq 3.150$  A; four plug-in terminals inner-cone type compliant with CEI EN 50180, clause 4.7.2 – interface: 3, with insulating cup usable also with the transformer in operation.

The bushing to be used for the neutral shall have the same characteristics as for solution a)

The bushings, both for phases and neutral, shall be installed such that to facilitate the connection with the cables terminals coming from the horizontal directions from the shorter side of the transformer tank. Slight inclinations are however admitted in order to facilitate the descent of the cables to ground.

	GLOBAL STANDARD	Page 160 of 182
	<b>POWER TRANSFORMERS</b> LOCAL SECTION ENEL DISTRIBUZIONE (ITALY)	<b>GST002</b> Rev. 01 15/01/2014

The plug-in bushings shall be in a single block for each phase terminal and interchangeable with the traditional oil/air polymeric type bushings.

For the possible substitution of the plug-in bushings, one or more windows shall be foreseen in order to allow the replacement without the removal of the tank cover.

## **7.2 ON LOAD TAP CHANGER**

### **7.2.1 Ratings**

The on load tap changer shall be vacuum type.

The regulating positions shall be in accordance with the transformer ratings.

The On Load Tap Changer shall be in accordance with the transformer characteristics with the change over selector either fine coarse type or reversing type.

### **7.2.2 Design requirements**

#### **Diverter switch**

The diverter switch contains an energy storage device, a set of moving and fixed contacts and the commutation resistances.

The diverter switch shall be installed into a sealed chamber which has to ensure the separation with the oil of the transformer. This chamber shall be connected with the relevant compartment contained into the main conservator of the transformer.

The diverter switch shall be moreover provided with the following devices:

- 1) Relays for the oil flux control (prescribed in item 19 of clause 6.8).
- 2) Pressure limitation device (rupture disk).

The diverter switch shall allow the maintenance operations and/or replacement without requiring the opening of transformer's tank.

#### **OLTC driving mechanism**

The OLTC shall be driven by a mechanism contained into a box, installed outside the tank of the transformer.

The moving mechanical parts connecting the motor drive and the diverter switch shall be fully protected with appropriate carters.

The commutation of the diverter switch shall be activated by an energy store device. The energy charge shall be achievable both through a motor drive and manually.

The motor drive commutation shall be achievable both remotely and locally through electric signals.

When the crank-handle is inserted, the electric/motorized commutation shall be inhibited through the interruption of both the supply circuit and the electric signalling circuit.



	GLOBAL STANDARD	Page 161 of 182
	<b>POWER TRANSFORMERS</b> LOCAL SECTION ENEL DISTRIBUZIONE (ITALY)	<b>GST002</b> Rev. 01 15/01/2014

### Tap-Selector and change-over selector

The tap-selector and the change-over selector shall be for installation inside the transformer tank.

### Cabinet

The OLTC control and driving devices shall be positioned inside a box, fixed on the transformer tank.

The box shall be manufactured with hot painted or galvanized steel sheets or with metal not susceptible to corrosion.

The box shall be IP 55 - IEC 60529 provided with an appropriate door, laterally hinged and lockable.

On the door, a window, protected with transparent material withstanding the atmospheric agents and UV radiations, which allow the visualization of the position indicator of the OLTC, shall be fitted.

All the wiring relevant to the signalling and command circuits (supplied at 100÷140 Vcc or 230 Vac) shall have a section not smaller than 1,5 mm<sup>2</sup>.

The wires for the connections inside the box shall be of the not-fire-propagate type, with insulating level Uo/U = 450/750 V; to the extremes of the flexible wires shall be applied pre-insulated compressed terminals and the extremes themselves shall be identifiable with appropriate marks.

The plugs of the marshalling shall be indirectly tightened, and shall be in compliance with EN 60947-7-2 and fixed on appropriate metallic support.

Inside the cabinet the following devices shall be located:

- 1) Push buttons or crank for the on-site electric commutation provided with the labels "increase MV" and "decrease MV"
- 2) Motor gear and the electrical devices for its command
- 3) Automatic circuit bracker on the motor circuit, provided with NC contacts wires in the marshalling
- 4) Heating anti-moisture resistance (always on) and additional heating resistance controlled by a thermostat and protected with automatic circuit bracher, provided with NC contacts wire in the marshalling, or with an equivalent system preventing the moisture generation
- 5) Ground terminal for of all the metallic parts of the box
- 6) Lamp and one single-phase
- 7) Socket 230V, 10 A, supply by the heating circuit
- 8) The protection and signalling devices;
- 9) One marshalling for the interface with the marshalling box of the transformer.



The supply voltages shall be:

- Three phase motor 400 V ± 10%, 50 Hz
- Command circuits 230 V ± 10%, 50 Hz
- Heating system 230 V ± 10%, 50 Hz
- Protection and signalling circuits 100 ÷ 140 Vdc

The contacts of the signals on the marshalling box are defined in the Table 8.

The marshalling of the motor drive is reported in Figure 13

#### 7.2.2.1 Painting

 	GLOBAL STANDARD	Page 162 of 182
	<b>POWER TRANSFORMERS</b> LOCAL SECTION ENEL DISTRIBUZIONE (ITALY)	<b>GST002</b> Rev. 01 15/01/2014

### 7.2.2.2 Maintenance

### 7.2.2.3 Functional requirements

The main functional requirements are the following.

- 1) The execution of the commutation shall be inhibited or interrupted when the over-current arrest relays (I max) installed outside the diverter switch activates.
- 2) A device that allows the completion of a tap commutation already started, regardless of the control activation time.
- 3) A device that prevents the execution of more than one commutation in case of control button pushed longer than time necessary to activate the commutation
- 4) An electrical and/or mechanical device for the motor drive re-starting after an interruption of the supply voltage, in order to complete a commutation already started
- 5) An electrical and a mechanical block that prevents commutations beyond the extreme positions
- 6) An electrical device that prevents the activation of an increasing commutation while a decreasing commutation is in operation and vice versa
- 7) A mechanical indicator of the position. The main central position shall be indicated with zero, the other positions shall correspond to the progressive number +1, +2, etc. e -1, -2, etc. from the central position respectively for increasing and decreasing the taps of the HV winding.
- 8) Electrical contacts for the indication of the tap positions.
- 9) Counter with 6 digits for the indication of the commutations number.

### 7.2.3 Tests

## 8 TESTS

### 8.1 LIST AND CLASSIFICATION OF TESTS

#### 8.1.1 Routine tests

- 13) Insulating oil tests
- 16) Active part inspection
- 17) Measurement of zero-sequence residual voltage.

#### 8.1.2 Additional routine tests for transformers with $U_m \geq 72,5$ KV

#### 8.1.3 Type tests

- 5) Temperature rise test with zero sequence current.
- 6) Tests on the rating plate.

#### 8.1.4 Special tests

- 2) Determination of transient voltage characteristics

#### 8.1.5 General statement for tests

##### 8.1.5.1 Short circuit test criteria

	GLOBAL STANDARD	Page 163 of 182
	<b>POWER TRANSFORMERS</b> LOCAL SECTION ENEL DISTRIBUZIONE (ITALY)	<b>GST002</b> Rev. 01 15/01/2014

## 8.2 TESTS DESCRIPTION

### 8.2.1 Routine tests

#### 8.2.1.13 Insulating oil tests

##### Certification of the oil

The new oil employed in the transformer shall be provided with the certificate which contains all the parameters prescribed in the IEC 60296 – Table 2, with the following additional specifications:

- The absence of corrosive sulphur shall be determined with the ASTM D1275 Method B, or with the more recent CCD method of IEC 62535
- The absence of DBDS shall be verified
- The oil Supplier shall declare possible anti-oxidant additives (type and concentration), if they are present.

For the above listed verifications the certification of the oil Supplier can be accepted. Such documentation shall however be included in the tests report documentation of the transformer.

##### Verification of the oil directly spilled from the transformer under test.

In the following parts the tests to be performed are specified. The two following possibilities are considered:

- A) Where the transformer is under certification, homologation (or updating of certification or homologation) or approval
- B) Where the transformer is under routine tests.

The documentation of the tests of the oil shall be enclosed in the test report of the transformer.

##### A) Certification, homologation or approval

The Manufacturer shall take the commitment to perform in an accredited independent laboratory, on an oil sample taken from the tank, the verifications below enlisted, according to the criteria defined in the IEC 60422–Table 3, where applicable and not otherwise specified:

- All the acceptance tests listed in B).
- Resistivity at 90°C.
- Oxidation stability.
- Interfacial tension (IFT).
- the absence of anti-oxidant additives shall be verified (IEC 60666 – verification of the “U” classification – not-inhibited oil).
- the absence of the DBDS shall be verified with a proper method.

Note: in case of transformer prototypes whose certifications are carried out within a short period (less than 4 months), for the subsequent prototype/s it is possible to perform only the acceptance test listed in B), if the oil producer and the oil type are the same.

##### B) Acceptance tests

- Colour and appearance.
- Breakdown voltage<sup>(1)</sup>.
- Water content.
- Acidity (neutralization value).
- Dielectric dissipation factor (DDF) at 90° C.

	GLOBAL STANDARD	Page 164 of 182
	<b>POWER TRANSFORMERS</b> LOCAL SECTION ENEL DISTRIBUZIONE (ITALY)	<b>GST002</b> Rev. 01 15/01/2014

- PCB content.
- 2-furfural content (IEC 61198 - limit 0,1 mg/kg)
- The absence of corrosive sulphur shall be determined with reference to the ASTM D1275 B method or with reference to the more recent CCD – IEC 62535 method

(1) When the transformer is under routine tests, the breakdown voltage can be performed at the Manufacturer factory with the presence of the Enel representative.

#### 8.2.1.16 Active part inspection

The active part shall be inspected by Enel representative, before the assembling into the tank. The Manufacturer shall communicate to Enel the date of the active part inspection at least 15 days in advance in case of factory location in Italy or one month in case of the factory location abroad.

At the date of the active part inspection, the continuously transposed cable mechanical test report (shall be already available).

#### 8.2.1.17 Measurement of zero-sequence residual voltage

The transformer shall be supplied from the HV side, with the three MV terminals short-circuited as for the load losses measurement, with a (practically) direct-sequence tern of phase-to-phase voltages (supply R, S, T respectively on terminals 1U, 1V, 1W). In such conditions the voltage between the three short-circuited MV terminals and the star-point N shall be measured.

The measurement shall be further repeated with a (practically) inverse-sequence tern of phase-to-phase voltages (supply R, S, T respectively on terminals 1V, 1U, 1W).

On the above prescribed conditions, the measurements shall be executed with the OLTC positioned on the central tap and shall be referred to the rated current.

*Note:* It is allowed to execute the measurements at reduced currents, provided that the measured values will be reported to the rated current, with the same method prescribed for the load losses measurements.

The average of the two zero-sequence voltage measurements (between the three sort-circuited MV terminals and the neutral N) shall not be higher than the limit values prescribed in the ratings clause (section 5.15) of this document.

Moreover, in the former measurement conditions, the measurements shall be performed and recorded, for acknowledgment purposes only, with the OLTC positioned on the extreme taps, min. and max, of the regulating range.

### 8.2.2 Additional routine tests for transformers with $U_m \geq 72,5$ KV

#### 8.2.3 Type tests

##### 8.2.3.5 Temperature rise test with zero-sequence current

The transformer shall be supplied form the MV side with a zero-sequence voltage (between the three MV terminal connected together and the neutral) by injecting the neutral current prescribed in 6.3 of this Local Section

The test shall be repeated after 30 minutes.

	GLOBAL STANDARD	Page 165 of 182
	<b>POWER TRANSFORMERS</b> LOCAL SECTION ENEL DISTRIBUZIONE (ITALY)	<b>GST002</b> Rev. 01 15/01/2014

The maximum over-temperature reached in the tank due to the neutral current circulation (usually some tens of seconds after the minute of the neutral current circulation) shall be measured through appropriate thermal probes applied in the expected hot-spot points (at least two for each side of the transformer).

The identification of those points may be facilitated by using a thermal camera; however, usually the most critical points are expected to be about on the half height of the tank, about the half-height of the core, and on the central part of the longest sides of the transformer.

The maximum measured over-temperature shall not exceed the prescribed value of 6.3.

The transformer with double secondary voltage shall be tested on the highest level.

#### 8.2.3.6 Tests on the rating plates

Three type tests, for each rating plate Supplier, shall be executed. Such tests, to be executed on n° 9 rating plates (n° 3 for each test), shall be performed accordingly to ENEL DY 2101, unless otherwise specified.

##### Accelerated ageing test

The test duration shall be 1000 hours. At the end of the test, no alterations on the film shall occur (cracks, detaching, or presence of "blister").

##### Salt-foggy chamber withstand test

The test duration shall be 1000 hours. At the end of the test, no alterations on the film shall occur (cracks, detaching, or presence of "blister").

##### Abrasion withstand test.

At the end of the test, the abrasion coefficient shall not be lower than 1,2 on all the rating plates tested.

#### 8.2.4 Special tests

##### 8.2.4.2 Determination of transient voltage transfer characteristics

The scope of the test is to check the characteristics of the over-voltages transferred by a low voltage impulse generator (1,2/100  $\mu$ s).

The impulse shall be applied between the HV terminal and earth in sequence. The HV terminals not impulsed shall be connected to earth by a 500  $\Omega$ /phase.

The MV terminals shall be in the following conditions:

- all terminals earthed by 500  $\Omega$ /phase resistors (1 config. for HV phase);
- all terminals free (1 config. for HV phase);
- each terminal earthed by a 500  $\Omega$  resistor, sequentially (3 config. for HV phase);
- one terminal free and the others connected to ground (3 config. for HV phase).

For each configuration the voltage applied and the voltage transferred on the MV terminals and between them and earth shall be recorded.

The test is passed if the MV over-voltages determined by reporting the HV impulse at the rated impulse values are not higher than the corresponding insulation value for the same MV terminal.

Note: in case of value exceeding the above defined acceptable value further considerations about the transformer in operation are necessary.

	GLOBAL STANDARD	Page 166 of 182
	<b>POWER TRANSFORMERS</b> LOCAL SECTION ENEL DISTRIBUZIONE (ITALY)	<b>GST002</b> Rev. 01 15/01/2014

## 9 SUPPLY REQUIREMENTS

### 9.1 TRANSPORT

The transformers with rated power of 16 MVA and 25 MVA shall be transportable in operating conditions (full of oil and fully assembled with bushings, radiators, conservator etc).

The transformers of 40 MVA and 63 MVA shall be transportable with the oil level decreased at the tank level and by disassembling HV bushings, radiators and conservator.

### 9.2 COMMISSIONING

### 9.3 DOCUMENTATION

#### 9.3.1 Documentation for the offer

#### 9.3.2 Documentation for homologation, certification and approval

##### 9.3.2.1 Not-reserved documentation (Type A)

##### 9.3.2.2 Reserved documentation (Type B)

### 9.4 GUARANTY

The general criteria of scheduled maintenance performed by Enel-Distribuzione are reported in the following Table. The maintenance activities are recorded by Enel managing system.

**TABLE 9: MAINTENANCE ACTIVITIES**

Activity	Frequency
Visual inspection	3 months
Inspection with infrared camera	1 years
DGA (internal procedure based on IEC 60599) Verification of oil parameters (internal procedure based on IEC 60422)	2 years
Bushings cleaning Check of the cooling system Check of transformers and OLTC control cabinets Check and cleaning of oil indicators and thermal probes Check of Buchholz relays of the transformers and oil flux relays of OLTC Any other verification when necessary	5 years
The frequency of the reported activities can be increase in case of specific needs	

## 10 EXCEPTIONS

## 11 FIGURES

In the following the Figures mentioned in this Local Sections are reported.

**FIGURE 1 – FRONT VIEW OF THE HV SIDE (FOR AIR LINES CONNECTIONS)**

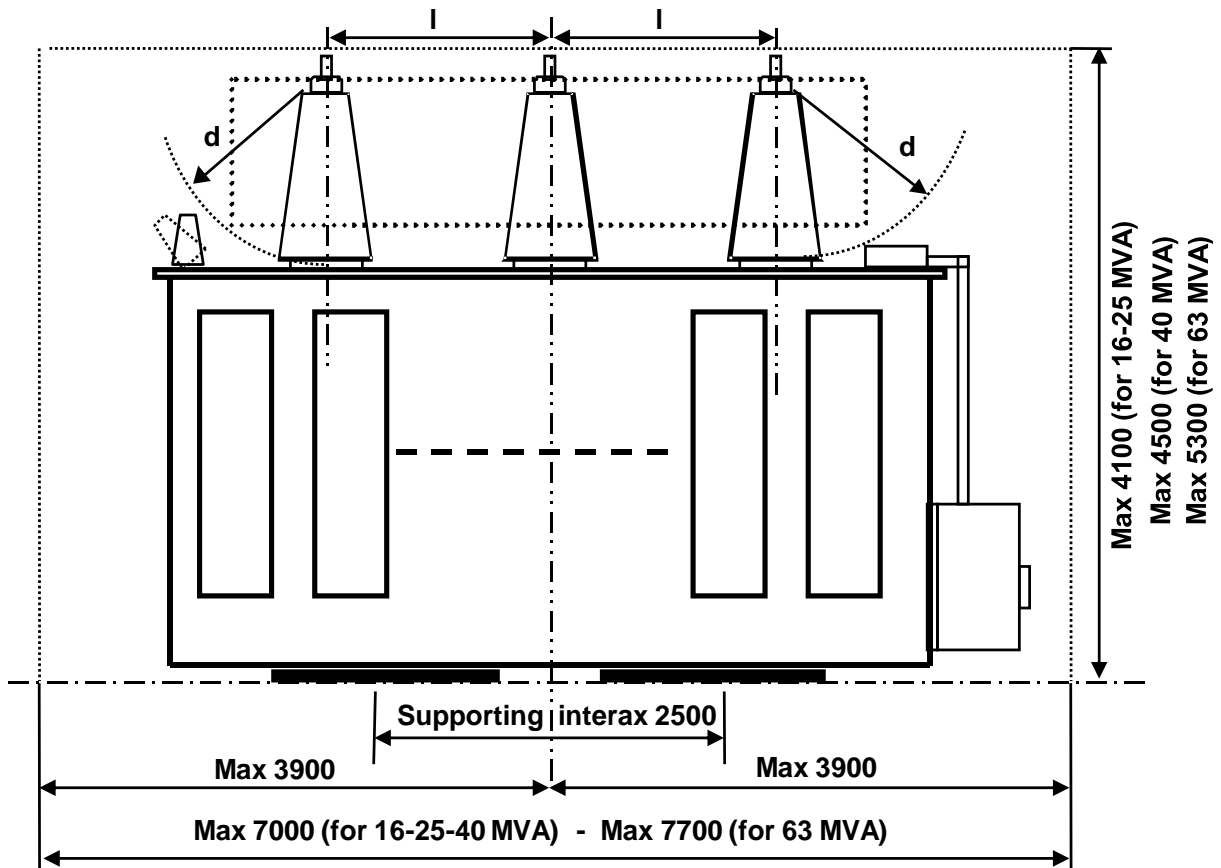

Rated Voltage (kV)	l (mm)	d (mm)
132	1400 <sup>+50</sup> <sub>-0</sub>	min. 850
150	1600 <sup>+50</sup> <sub>-0</sub>	min. 1000

- 1) The bushings can be installed at max. 30° from the vertical
- 2) The possible radiators installed on the shorter side of the transformer shall not overcome, with their top, the horizontal plane identified by the base of the hollow insulator
- 3) The axes of the HV bushings and the ones of the supporting plates shall coincide; however, the maximum allowable deviation shall be no longer than 250 mm.



	GLOBAL STANDARD	Page 168 of 182
	<b>POWER TRANSFORMERS</b> LOCAL SECTION ENEL DISTRIBUZIONE (ITALY)	<b>GST002</b> Rev. 01 15/01/2014

FIGURE 2 – LATERAL VIEW FROM THE MV SIDE (AIR LINES CONNECTIONS)



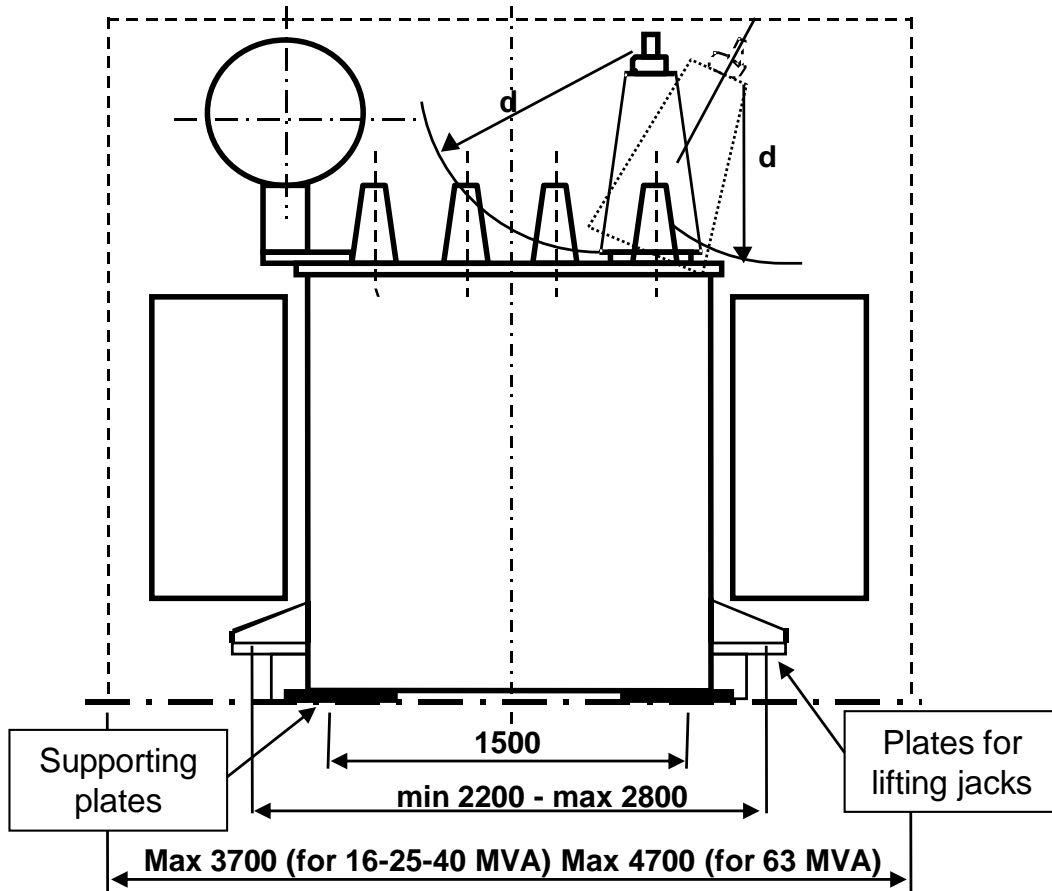

	GLOBAL STANDARD	Page 169 of 182
	<b>POWER TRANSFORMERS</b> LOCAL SECTION ENEL DISTRIBUZIONE (ITALY)	<b>GST002</b> Rev. 01 15/01/2014

**FIGURE 3 – OVERVIEW (FOR AIR LINES CONNECTIONS)**

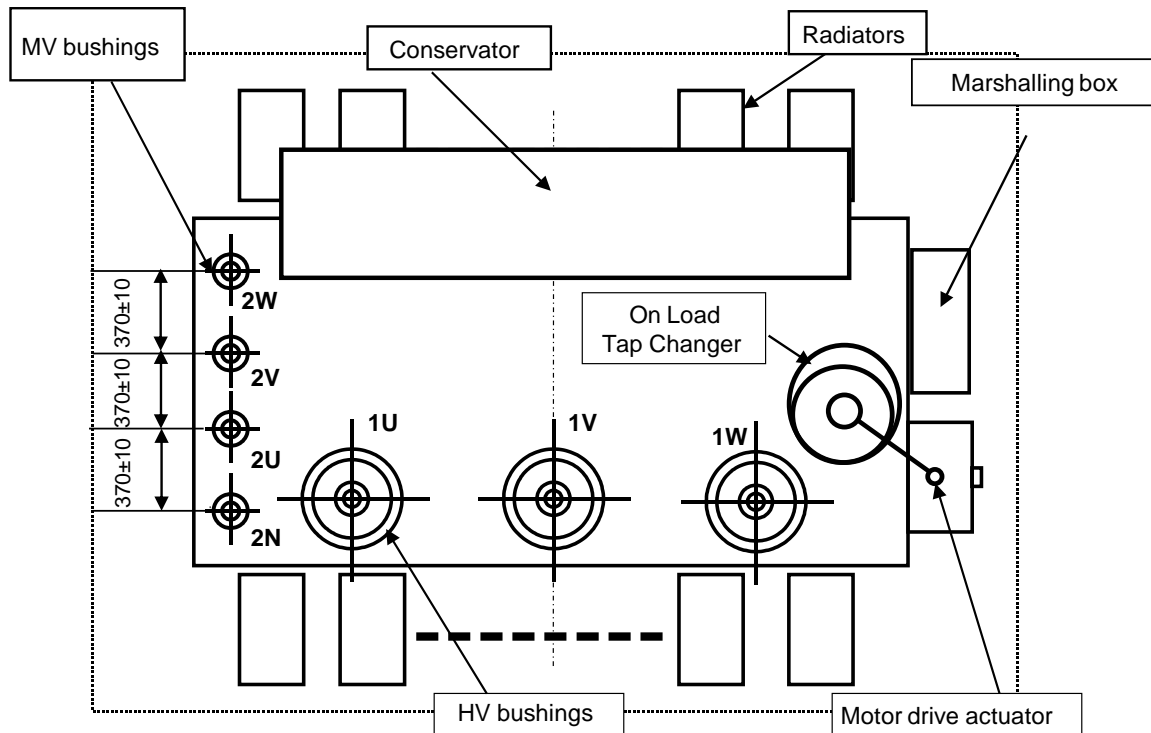

**FIGURE 4 – FRONT VIEW FROM THE HV SIDE FOR GIS CONNECTONS OR CABLE TERMINATION BOXES**

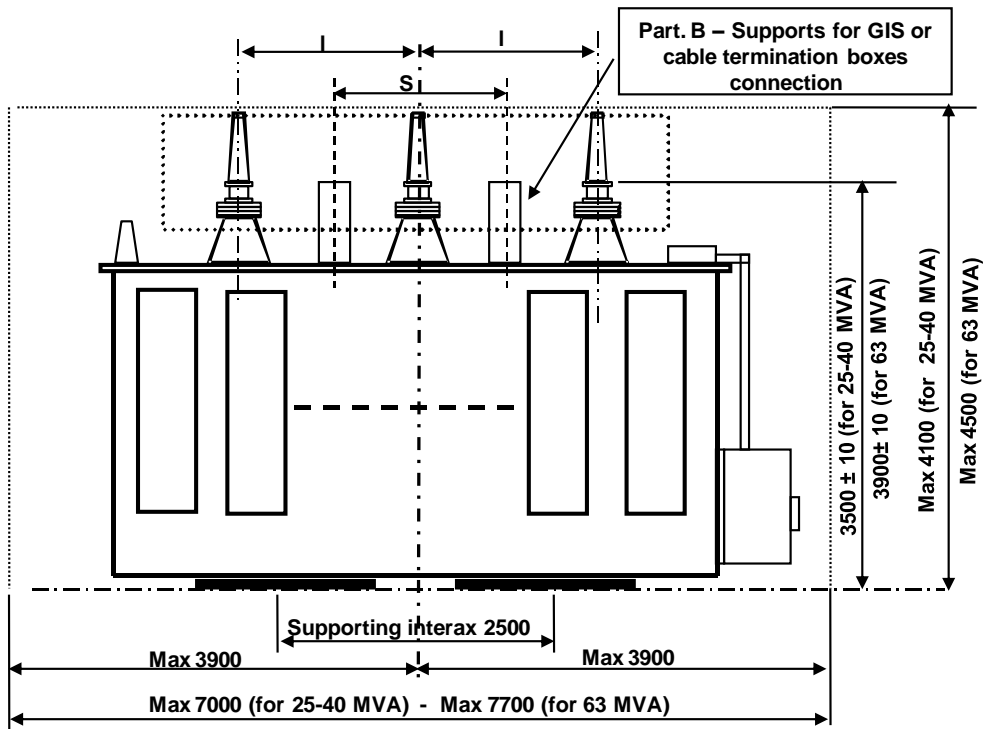

Rated Voltage of HV terminals (kV)	l (mm)	S (mm)
132	1400 ± 5	1400 ± 5
150	1600 ± 5	1600 ± 5

Notes:

The supports in the **Part. B** shall be removable and shall withstand:

- The SF<sub>6</sub> pipes of HV connections, which can apply a maximum load per phase of 4000 N, both horizontally and vertically.
- The oil cable box for the junction of the HV cables.

THE AXIS OF THE HV BUSHINGS AND THE ONES OF THE SUPPORTING PLATES SHALL COINCIDE.

	GLOBAL STANDARD	Page 171 of 182
	<b>POWER TRANSFORMERS</b> LOCAL SECTION ENEL DISTRIBUZIONE (ITALY)	<b>GST002</b> Rev. 01 15/01/2014

**FIGURE 5 – LATERAL VIEW FROM THE MV SIDE FOR GIS CONNECTION OR CABLE TERMINATION BOXES**

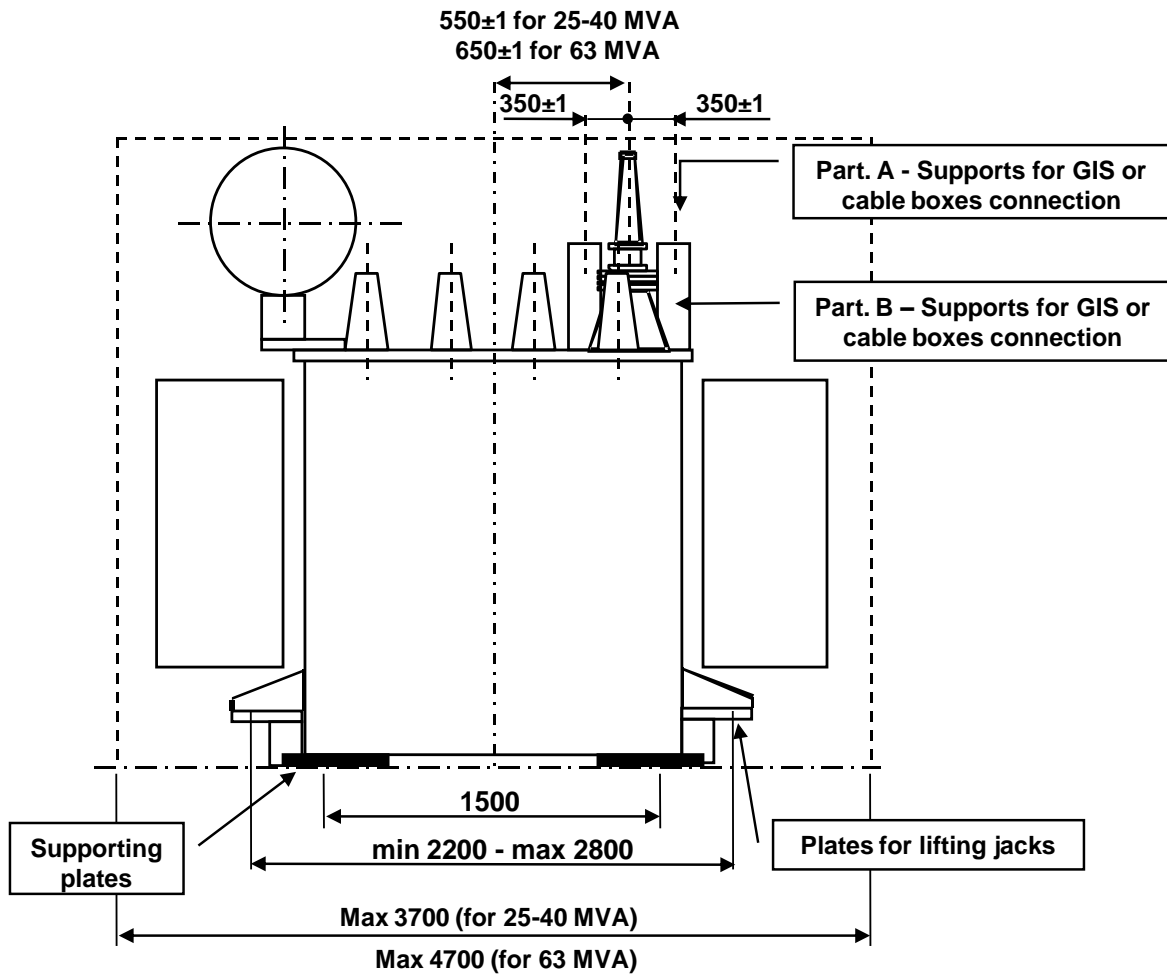

**PART. A – SUPPORTS FOR GIS OR CABLE BOXES**

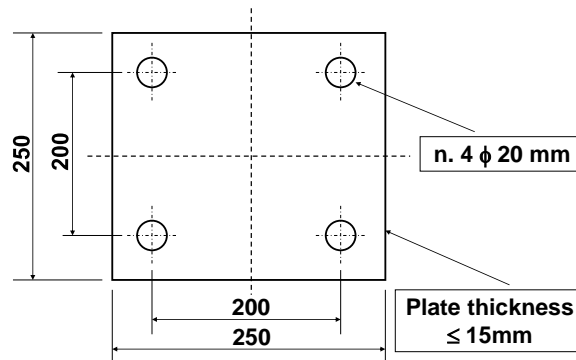

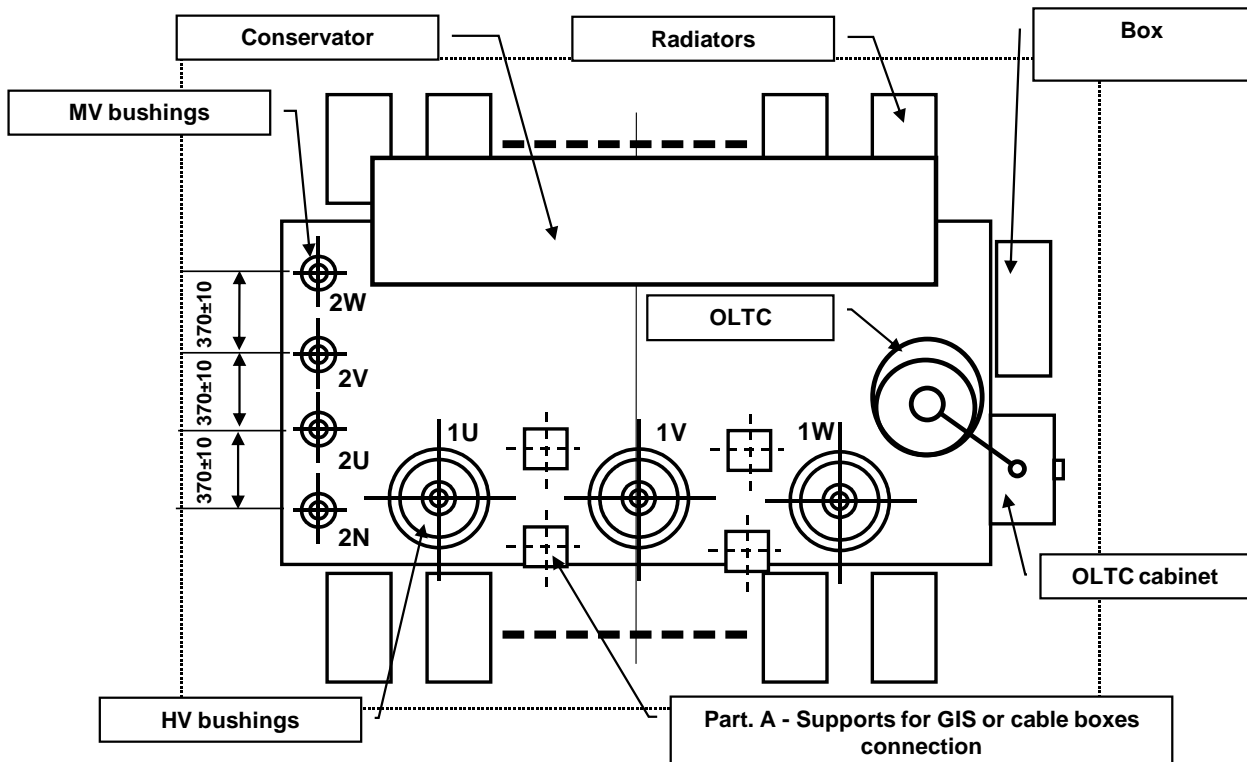

**FIGURE 6 – OVERVIEW FOR CONNECTIONS WITH GIS OR CABLE BOXES**

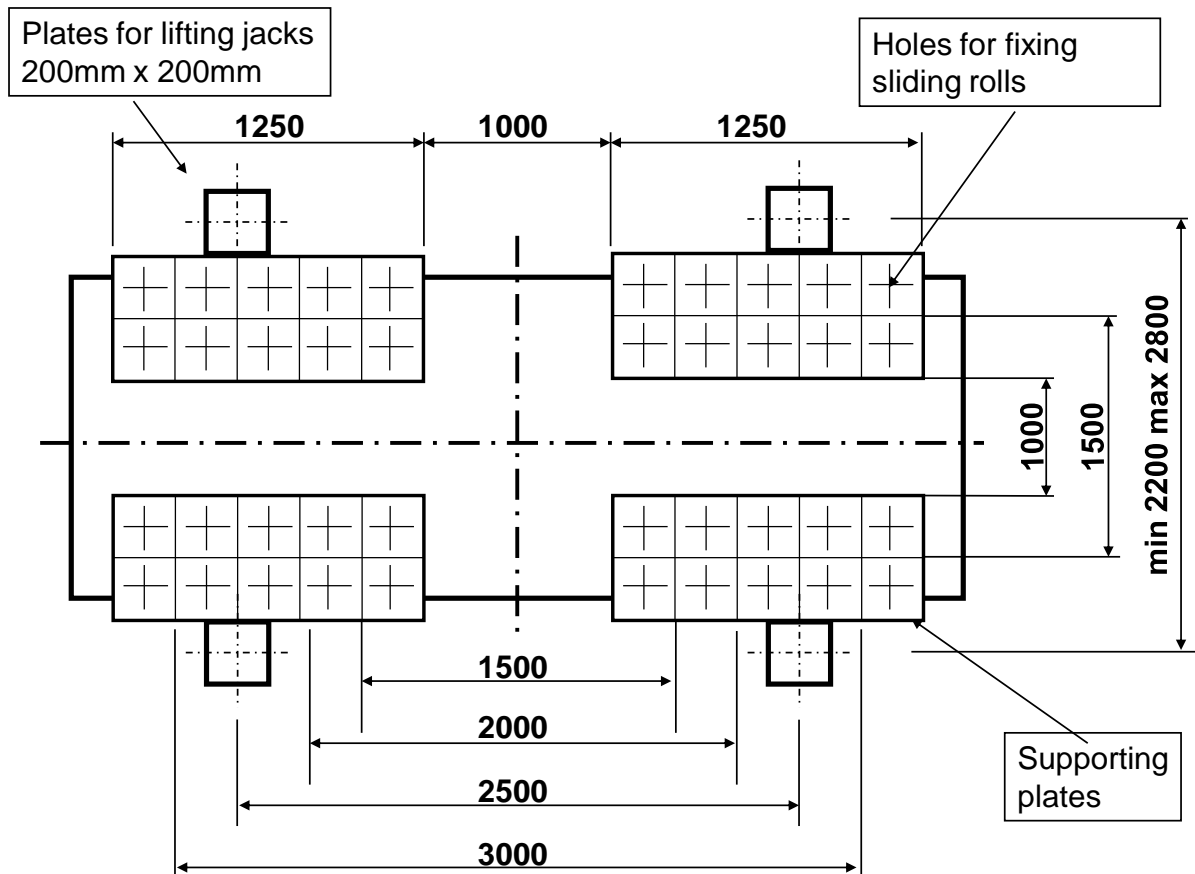
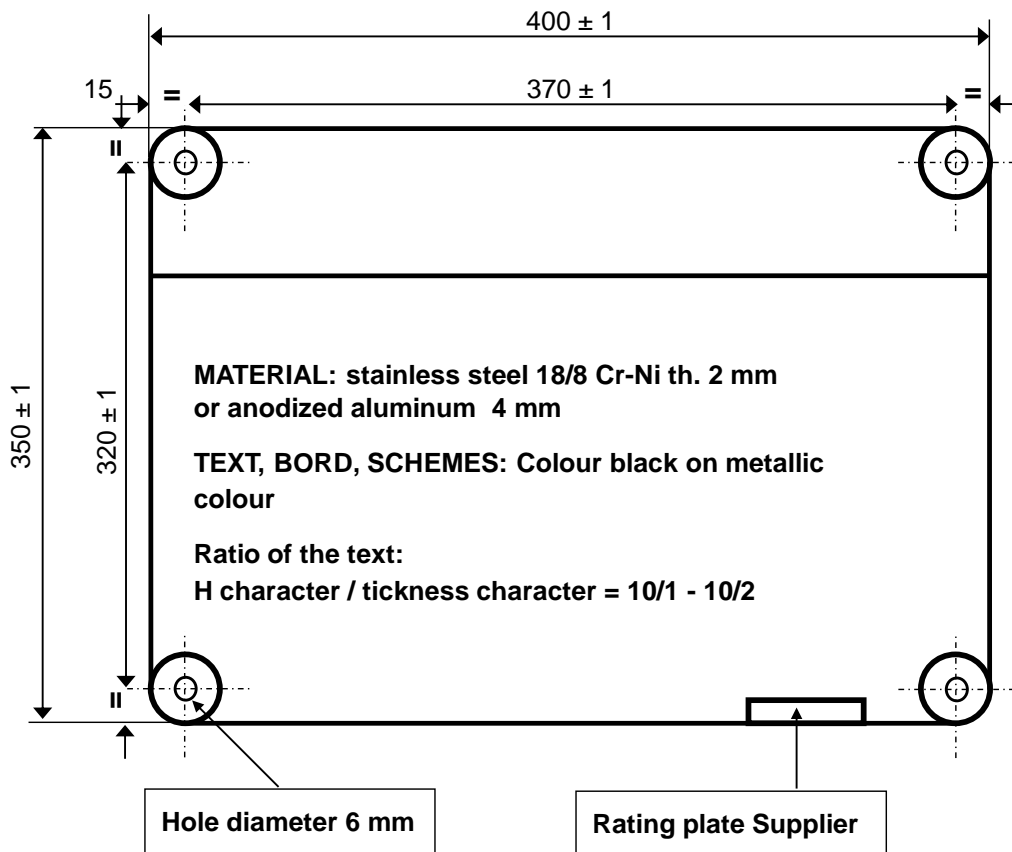

**FIGURE 7 – SUPPORTING PLATES**



 	GLOBAL STANDARD	Page 174 of 182
	<b>POWER TRANSFORMERS</b> LOCAL SECTION ENEL DISTRIBUZIONE (ITALY)	<b>GST002</b> Rev. 01 15/01/2014

**FIGURE 8 - DIMENSIONS AND CHARACTERISTICS OF THE RATING PLATES**





POWER TRANSFORMERS

LOCAL SECTION  
ENEL DISTRIBUZIONE (ITALY)

GST002

Rev. 01

15/01/2014

FIGURE 9 - RATING PLATE FOR TRANSFORMER WITH ONE VOLTAGE ON MV SIDE

CEI EN 60076 Marchio e ragione sociale del Costruttore

**TRASFORMATORE TRIFASE** SIGLA Costruttore TIPO DT 1083 / \_

N. [ ] ANNO [ ] 50Hz TIPO ONAN PER ESTERNO  
Regolazione della tensione AT di tipo A SOSTITUZIONE / AD INVERSIONE

POTENZA NOMINALE [ ] kVA

Avvolgimento	Tensione nominale	Corrente nominale	Livelli di Isolamento	Simbolo di collegamento	Yyn0
AT con C.S.C.	[ ]	[ ]	IA ..... / IND..... / APP .....		
MT	20,8 kV	[ ]	IA ..... / APP .....	3 - 4 = 20,8 kV	
	10,4 kV	[ ]	IA ..... / APP .....	2U-4 ; 3-2N= 10,4 kV	
Zcc	[ ] %	(C.S.C. +12x1,25%	Rapp	/MT)	
	[ ] %	(C.S.C. 0	Rapp	/MT)	
	[ ] %	(C.S.C. -12x1,25%	Rapp	/MT)	

MASSE OLIO ESTRAIBILE TOTALE [ ] t

Il trasformatore pieno d'olio e completo di tutti gli accessori è idoneo al sollevamento e alla movimentazione

Cassa e conservatore adatti al vuoto

Disegno Relativo al tipo di regolazione adottata

MINIMA ALTEZZA DEL GANCIO DELLA GRU [ ] m

FIGURE 10 - RATING PLATE FOR TRANSFORMER WITH DOUBLE VOLTAGE ON MV SIDE

CEI EN 60076 Marchio e ragione sociale del Costruttore

**TRASFORMATORE TRIFASE** SIGLA Costruttore TIPO DT 1083 / \_

N. [ ] ANNO [ ] 50Hz TIPO ONAN PER ESTERNO  
Regolazione della tensione AT di tipo A SOSTITUZIONE / AD INVERSIONE

POTENZA NOMINALE [ ] kVA

Avvolgimento	Tensione nominale	Corrente nominale	Livelli di Isolamento	Simbolo di collegamento	Yyn0
AT con C.S.C.	[ ]	[ ]	IA ..... / IND..... / APP .....		
MT	[ ]	[ ]	IA ..... / APP.....		
Zcc	[ ] %	(C.S.C. +12x1,25%	Rapp .	/MT)	
	[ ] %	(C.S.C. 0	Rapp .	/MT)	
	[ ] %	(C.S.C. -12x1,25%	Rapp .	/MT)	

MASSE OLIO ESTRAIBILE TOTALE [ ] t

Il trasformatore pieno d'olio e completo di tutti gli accessori è idoneo al sollevamento e alla movimentazione

Cassa e conservatore adatti al vuoto

Disegno Relativo al tipo di regolazione adottata

MINIMA ALTEZZA DEL GANCIO DELLA GRU [ ] m

**FIGURE 11 – MARSHALLING OF TRANSFORMER SIGNALS**

The name of identification of the contacts is reported in Italian language, as requested to the Supplier for the corresponding drawings (the translation in English is given in the following)

1			
2		Minimo livello olio Trasformatore	allarme ( 99 QT )
3		Minimo livello olio C.S.C.	allarme ( 99 QC )
4			
5		Relè Buchholz Trasformatore	allarme ( 97 T )
6			
7		Relè Buchholz Trasformatore	scatto ( 97 T )
8			
9		Massima temperatura olio TR	allarme ( 26 Q )
10			
11		Massima temperatura olio TR	scatto ( 26 Q )
12			
13			
14		Relè a flusso olio C.S.C.	( 97 C )
15			
16		Relè Buchholz flangia isolatore olio-SF <sub>6</sub> / olio-olio	allarme ( 97 F )
17			
18		Relè Buchholz flangia isolatore olio-SF <sub>6</sub> / olio-olio	scatto ( 97 F )
19			
20		Manometro isolatore fase U	minima pressione ( 63 U )
21		Manometro isolatore fase U	massima pressione ( 63 U )
22		Manometro isolatore fase V	minima pressione ( 63 V )
23		Manometro isolatore fase V	massima pressione ( 63 V )
24		Manometro isolatore fase W	minima pressione ( 63 W )
25		Manometro isolatore fase W	massima pressione ( 63 W )
26			
27		Manometro isolatore fase W	massima pressione ( 63 W )
28			
29		Manometro isolatore fase W	minima pressione ( 63 W )
30		Manometro isolatore fase W	massima pressione ( 63 W )
31			
32		Relè Buchholz Muffole olio	allarme ( 97 M )
33			
34		Relè Buchholz Muffole olio	scatto ( 97 M )
35			
36			
37		Termosonda nel ferro	
38		Giogo fase V	
39			
40		Termosonda nel ferro	
41		Finestra fase V	
42			
43		Disponibili	
44			
45		Alimentazione riscaldamento ed illuminazione	
46		armadio di centralizzazione - 230 V a.c.	
47			
48		Anomalia riscaldamento e illuminazione	
		armadio di centralizzazione	

**FIGURE 12 – MARSHALLING OF THE SELF-REGENERATING BREATHERS**

(Examples for two separate breathers for transformer and OLTC)

81			
82		Alimentazione essiccatore trasformatore - 230 V a.c.	( 98 T )
83			
84		Anomalia essiccatore trasformatore	( 98 T )
85			
86		Riscaldamento sali trasformatore	( 98 T )
87			
88			
89		Segnale analogico essiccatore trasformatore	( 98 T )
90			
91		Alimentazione essiccatore C.S.C. - 230 V a.c.	( 98 C )
92			
93		Anomalia essiccatore C.S.C.	( 98 C )
94			
95		Riscaldamento sali C.S.C.	( 98 C )
96			
97			
98		Segnale analogico essiccatore C.S.C.	( 98 C )





POWER TRANSFORMERS  
LOCAL SECTION  
ENEL DISTRIBUZIONE (ITALY)

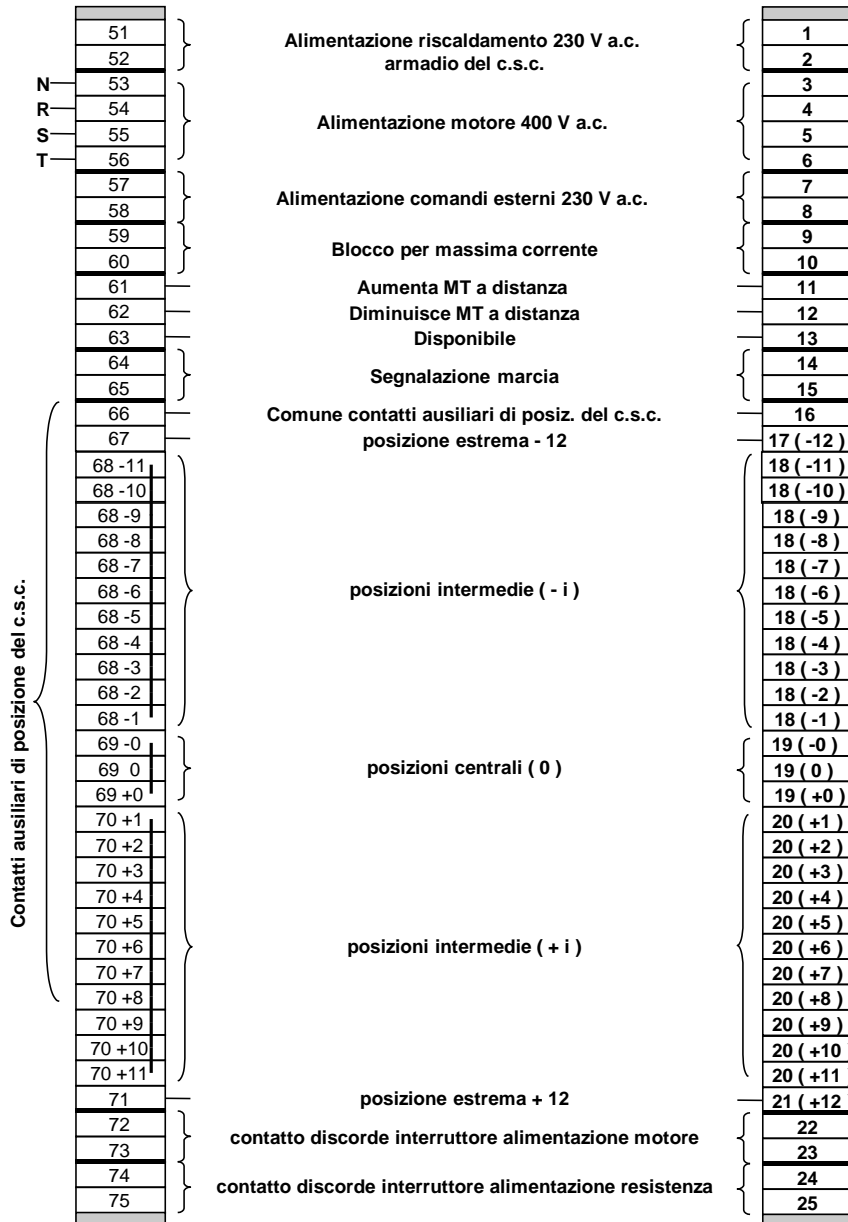

GST002  
Rev. 01  
15/01/2014

FIGURE 13 – MARSHALLING OF THE OLTC SIGNALS



Morsettiera armadio  
di centralizzazione  
del trasformatore

Morsettiera armadio  
del comando a motore  
del commutatore

 	GLOBAL STANDARD	Page 178 of 182
	<b>POWER TRANSFORMERS</b> LOCAL SECTION ENEL DISTRIBUZIONE (ITALY)	<b>GST002</b> Rev. 01 15/01/2014

**TRANSLATION OF THE TEXT IN FIGURE 11, 12 AND 13**

Contacts	Translation	
1-2	Minimum oil level of the transformer	Alarm (99 QT)
3-4	Minimum oil level of the OLTC	Alarm (99 QC)
5-6	Buchholz relays of the transformer	Alarm (97 T)
7-8	Buchholz relays of the transformer	Trip (97 T)
9-10	Maximum oil temperature of the transformer	Alarm (26 Q)
11-12	Maximum oil temperature of the transformer	Trip (26 Q)
13-14-15	Oil flow relays of the OLTC	Trip (97 C)
16-17	Buchholz relays of the bushing flange oil/SF6-oil oil	Alarm (97 F)
18-19	Buchholz relays of the bushing flange oil/SF6-oil oil	Trip (97 F)
20-21	Pressure gauge bushing phase U	minimum pressure (63 U)
22-23	Pressure gauge bushing phase U	maximum pressure (63 U)
24-25	Pressure gauge bushing phase V	minimum pressure (63 V)
26-27	Pressure gauge bushing phase V	maximum pressure (63 V)
28-29	Pressure gauge bushing phase V	minimum pressure (63 W)
30-31	Pressure gauge bushing phase V	maximum pressure (63 W)
32-33	Buchholz relays of the oil cable box	Alarm (97 M)
34-35	Buchholz relays of the oil cable box	Trip (97 M)
36-37-38	Thermal probe of the core – yoke phase V	
39-40-41	Thermal probe of the core – window phase V	
42-43-44	Available	
45-46	230 Vac Supply of marshalling box heating and lightning	
47-48	Anomaly of marshalling box heating and lightning	
51-52	230 Vac Control cabinet heating supply	
53-54-55-56	400 Vac Motor drive supply	
57-58	230 Vac remote signal supply	
59-60	Max current stop	
61	"Increase MV" remote signal	
62	"Decrease MV" remote signal	
63	Available	
64-65	"Motor On" signalling	
66	Common of OLTC auxiliary contact positions	
67	Extreme position -12	
68	Intermediate positions (- i)	
69	Central positions 0	
70	Intermediate positions (+ i)	
71	Extreme positions +12	
72-73	NC contact of the circuit breaker of the motor drive supply	
74-75	NC contact of the circuit breaker of the heating resistance supply	
81-82	230 Vac Supply self-regenerating breather/s of the transformer	(98 T)
83-84	Anomaly self-regenerating breather/s of the transformer	(98 T)
85-86-87	Warming on self-regenerating breather/s of the transformers	(98 T)
88-89	Analogue remote signal self-regenerating breather/s of the transformers	(98 T)
90-91	230 Vac Supply self-regenerating breather/s of the OLTC	(98 C)
92-93	Anomaly self-regenerating breather/s of the OLTC	(98 C)
94-95-96	Warming on self-regenerating breather/s of the OLTC	(98 C)
97-98	Analogue remote signal self-regenerating breather/s of the OLTC	(98 C)

POWER TRANSFORMERS

LOCAL SECTION  
ENEL DISTRIBUZIONE (ITALY)

GST002

Rev. 01

15/01/2014

FIGURE 14 – OIL TO AIR BUSHING

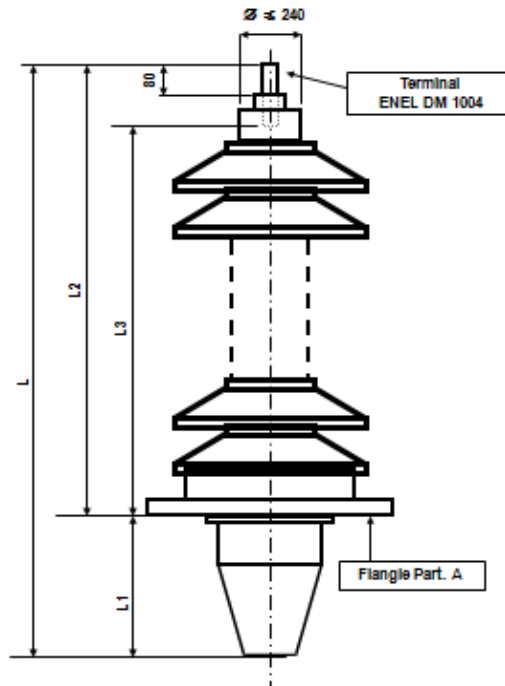

PART. A – FLANGE TRANSFORMER SIDE

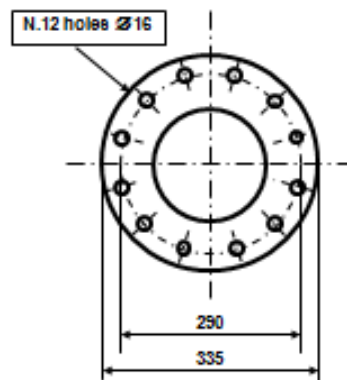

POWER TRANSFORMERS

LOCAL SECTION  
ENEL DISTRIBUZIONE (ITALY)

GST002

Rev. 01

15/01/2014

FIGURE 15 – OIL/SF<sub>6</sub> AND OIL/OIL BUSHING

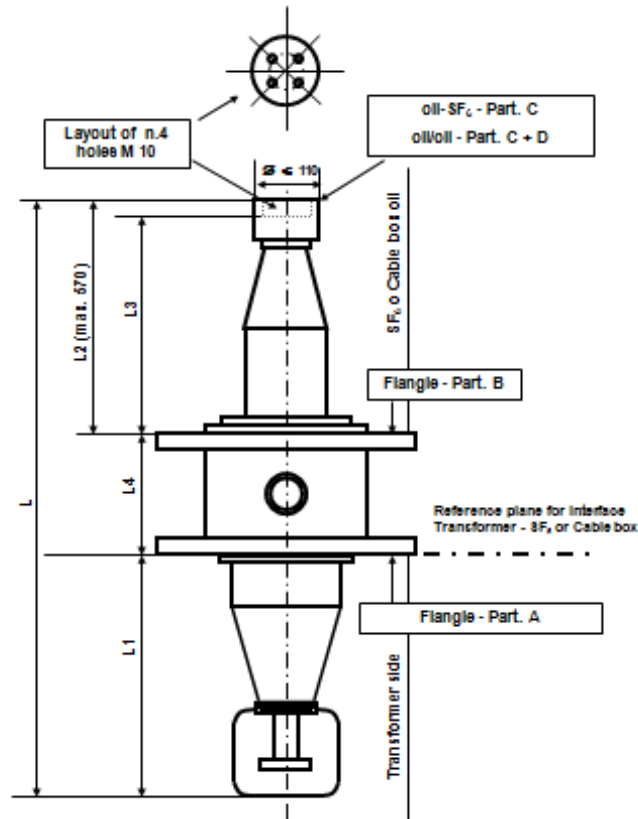

PART B – FLANGE GIS OR CABLE BOX SIDE

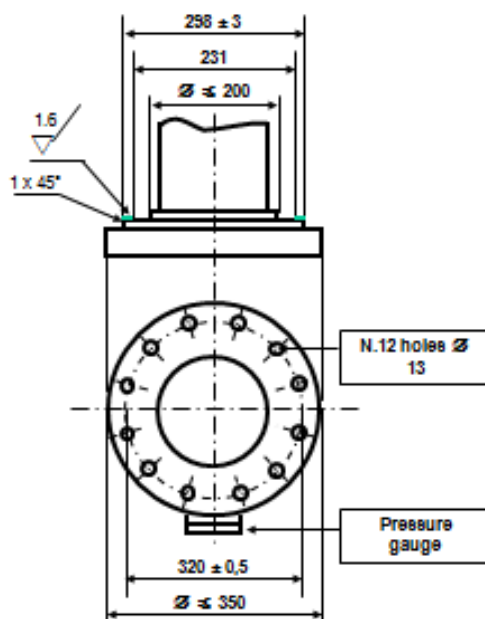



POWER TRANSFORMERS

LOCAL SECTION  
ENEL DISTRIBUZIONE (ITALY)

GST002

Rev. 01

15/01/2014

**PART. C – TERMINAL FOR GIS AND OIL/OIL**

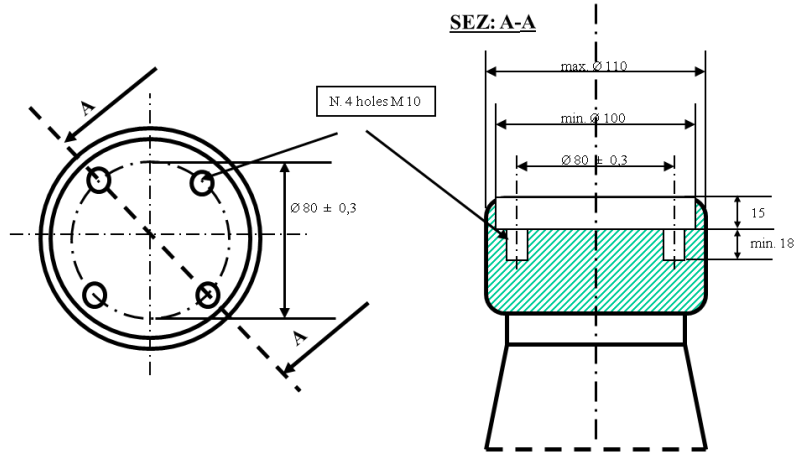

**PART. D – DIFFERENT SOLUTION FOR OIL/OIL**

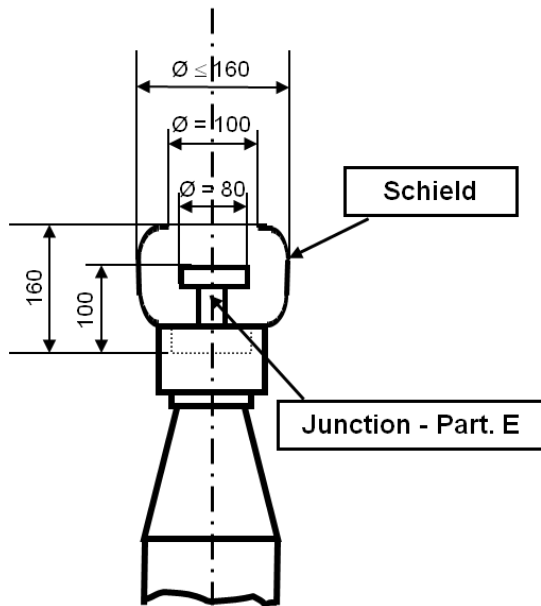

**PART.E – JUNCTION OIL/OIL**

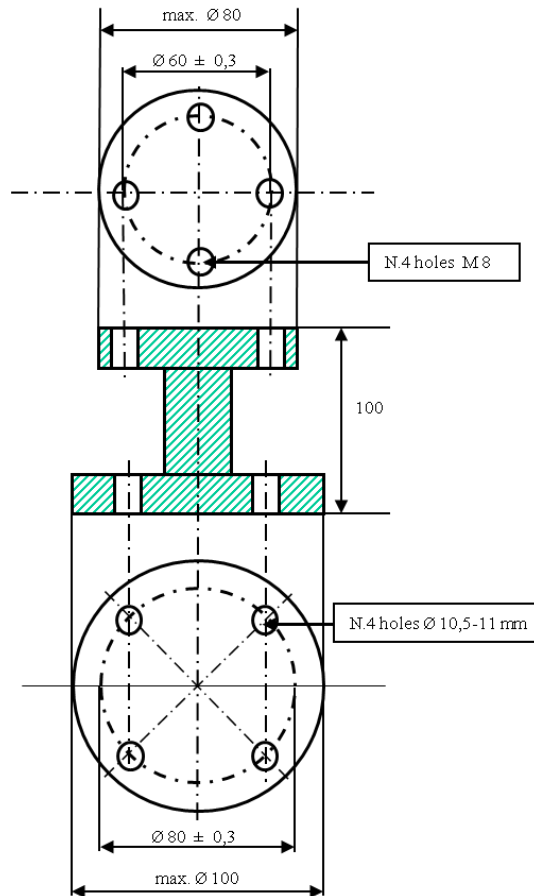

POWER TRANSFORMERS

LOCAL SECTION  
ENEL DISTRIBUZIONE (ITALY)

GST002

Rev. 01

15/01/2014

FIGURE 16 - MV BUSHING TYPES AND DIMENSIONS

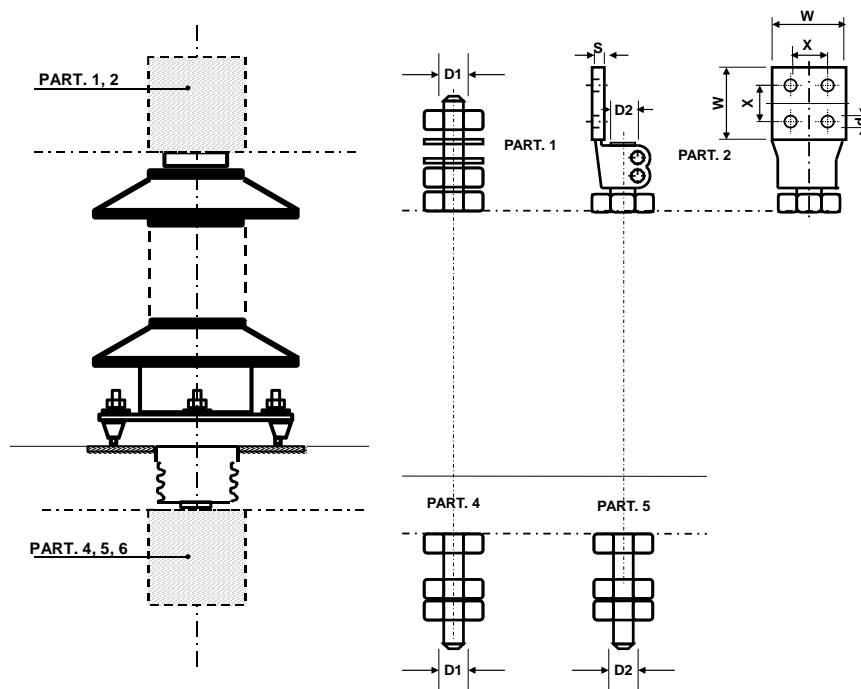

Type	Classification EN 50180	$I_r$ (A)	Upper interface	Lower interface	D1 (mm)	D2 (mm)	W (mm)	X (mm)	d (mm) x n° holes	S (mm)
DJ 1106/1	24-250/P3	250	Part. 1	(*)	M12	--	--	--	--	--
DJ 1106/2	24-630/P4	630	Part. 1	Part. 4	M20	--	--	--	--	--
DJ 1106/3	24-1250/P3	1250	Part. 2	Part. 5	--	M30x2	60	32	14 x 2	12
DJ 1106/4	24-2000/P3	2000	Part. 2	Part. 5	--	M42x3	100	50	18 x 4	20
DJ 1106/5	24-3150/P3	3150	Part. 2	Part. 5	--	M48x3	120	60	18 x 4	20

(\*) direct connection to the upper plug