



**Technical Specification code: MAT-E&C-NC-2021-0052-EGIN**

Version no. 2 dated 08/07/2021

**Subject:** Global Infrastructure and Networks – GSM001 - MV RMU with switch-disconnector

**Application Areas**

Perimeter: *Global*

Staff Function: -

Service Function: -

Business Line: *Infrastructure & Networks*

## CONTENTS

1. DOCUMENT AIMS AND APPLICATION AREA .....	2
2. DOCUMENT VERSION MANAGEMENT .....	2
3. UNITS IN CHARGE OF THE DOCUMENT .....	3
4. REFERENCES .....	3
5. ORGANIZATIONAL PROCESS POSITION IN THE PROCESS TAXONOMY .....	3
6. DEFINITIONS AND ACRONYMS .....	3
7. DESCRIPTION .....	6
8. ANNEX A - INTERLOCKS CHECKING .....	54
9. ANNEX B - CHARACTERISTICS OF THE ELECTRICAL COMMAND .....	56
10. ANNEX C – LOCAL CODES .....	62
11. ANNEX D - FORM FOR SPECIFIC DEVIATIONS .....	67
12. ANNEX E - CHECK-LIST .....	69

**THE HEAD OF NETWORK COMPONENTS**

**Maurizio Mazzotti**

**Technical Specification code: MAT-E&C-NC-2021-0052-EGIN**

Version no. 2 dated 08/07/2021

**Subject:** Global Infrastructure and Networks – GSM001 - MV RMU with switch-disconnector

**Application Areas**
Perimeter: *Global*

Staff Function: -

Service Function: -

Business Line: *Infrastructure & Networks*

## 1. DOCUMENT AIMS AND APPLICATION AREA

The scope of this document is to provide the technical requirements for the supply of MV RMU (Ring Main Unit) with external plug-in type bushings to be used in Secondary Substations of the Enel Group Distribution Companies, listed below:

Country	Distribution Company
Argentina	Edesur
Brazil	Enel Distribuição Rio Enel Distribuição Ceará Enel Distribuição Goiás Enel Enel Distribuição São Paulo
Chile	Enel Distribución Chile
Colombia	Codensa
Iberia	e-distribución
Italy	e-distribuzione
Peru	Enel Distribución Perú
Romania	Enel Distributie Banat Enel Distributie Dobrogea Enel Distributie Muntenia

**Table 1 - Distribution Companies**

### 1.1 RELATED DOCUMENTS TO BE IMPLEMENTED AT COUNTRY LEVEL

This document applies to both Enel Global Infrastructure and Networks Srl Company and to Infrastructure and Networks Business Line perimeter when each Company does not have to issue further documents.

## 2. DOCUMENT VERSION MANAGEMENT

Version	Date	Main changes description
2	08/07/2021	Release of "Global Infrastructure and Networks – GSM001 vers.2. Standardized format release, editorial errors correction.



**Technical Specification code: MAT-E&C-NC-2021-0052-EGIN**

Version no. 2 dated 08/07/2021

**Subject:** Global Infrastructure and Networks – GSM001 - MV RMU with switch-disconnector

**Application Areas**

Perimeter: *Global*

Staff Function: -

Service Function: -

Business Line: *Infrastructure & Networks*

### 3. UNITS IN CHARGE OF THE DOCUMENT

Responsible for drawing up the document:

- Global Infrastructure and Networks: Operation and Maintenance / Network Components Standardization

Responsible for authorizing the document:

- Global Infrastructure and Networks: Head of Operation and Maintenance unit
- Global Infrastructure and Networks: Head of Health, Safety, Environment and Quality unit.

### 4. REFERENCES

- Code of Ethics of Enel Group.
- Enel Human Right Policy.
- The Enel Group Zero Tolerance of Corruption (ZTC) Plan.
- Organization and management model as per Legislative Decree No. 231/2001.
- RACI Handbook Infrastructure and Networks no. 06.
- Enel Global Compliance Program (EGCP).
- Integrated Policy of Quality, Health and Safety, Environment and anti-Bribery.

### 5. ORGANIZATIONAL PROCESS POSITION IN THE PROCESS TAXONOMY

Value Chain/Process Area: Networks Management

Macro Process: Materials management

Process: Network Components Standardization

### 6. DEFINITIONS AND ACRONYMS

Acronym and Key words	Description
<b>Manufacturer Product</b>	Component manufactured by a Supplier in accordance with a technical specification
<b>Technical Conformity Assessment (TCA)</b>	A “conformity assessment” <sup>1</sup> with respect to “specified requirements” <sup>2</sup> consists in functional, dimensional, constructional and test characteristics required for a product (or a series of products) and quoted in technical specifications and

<sup>1</sup> Definition 2.1 of ISO/IEC 17000

<sup>2</sup> Definition 3.1 of ISO/IEC 17000

**Technical Specification code: MAT-E&C-NC-2021-0052-EGIN**

Version no. 2 dated 08/07/2021

**Subject:** Global Infrastructure and Networks – GSM001 - MV RMU with switch-disconnector

**Application Areas**
Perimeter: *Global*

Staff Function: -

Service Function: -

Business Line: *Infrastructure & Networks*

	quality requirements issued by Enel Group distribution companies. This also includes the verification of conformity with respect to local applicable regulation and laws and possession of relevant requested certifications
<b>Conformity assessment body</b>	Body that performs the conformity assessment activities [ISO 17000]
<b>Enel Equipment Key code</b>	It's an equipment representative for a group (family) of similar equipment chose by Enel
<b>Enel Equipment Family code</b>	Equipment belonging to a specific group (family) in which another equipment is identified as key code
<b>TCA systems</b>	The “conformity assessment systems”, is applicable specifying that the rules and procedures to carry on the TCA are those specified in the present document
<b>Type A documentation</b>	Not confidential documents used for product manufacturing and management from which it is possible to verify the product conformity to all technical specification requirements, directly or indirectly
<b>Type B documentation</b>	Confidential documents used for product manufacturing and management where all product project details are described, in order to uniquely identify the product object of the TCA
<b>TCA report</b>	Document describing the activities carried out for TCA
<b>TCA dossier</b>	Set of final documents delivered by the Supplier for the TCA
<b>Material LifeCycle Management (MLM)</b>	Integrated IT platform to manage the processes of Technical Specifications (TSM), Technical Conformity Assessment (TCA), Quality Control Tools (QCA), Defects Managing (CMD), Warranties and Materials Shipping (MSH)

**Enel Global Infrastructure and Networks countries Reference standards**

Reference documents listed below (amendments included) shall be the edition in-force at the contract date.

ISO/IEC 17000	Conformity assessment – Vocabulary and general principles
ISO/IEC 17020	General criteria for the operation of various types of bodies performing inspection
ISO/IEC 17025	General requirements for the competence of testing and calibration laboratories
ISO/IEC 17050-1	Conformity assessment - Supplier's declaration of conformity - Part 1: General requirements (ISO/IEC 17050-1:2004, corrected version 2007-06-15)
ISO/IEC 17050-2	Conformity assessment - Supplier's declaration of conformity - Part 2: Supporting documentation (ISO/IEC 17050-2:2004)
ISO/IEC 17065	Conformity assessment – Requirements for bodies certifying products, processes and services



**Technical Specification code: MAT-E&C-NC-2021-0052-EGIN**

Version no. 2 dated 08/07/2021

**Subject:** Global Infrastructure and Networks – GSM001 - MV RMU with switch-disconnector

**Application Areas**

Perimeter: *Global*

Staff Function: -

Service Function: -

Business Line: *Infrastructure & Networks*

---



Technical Specification code: MAT-E&C-NC-2021-0052-EGIN

Version no. 2 dated 08/07/2021

**Subject:** Global Infrastructure and Networks – GSM001 - MV RMU with switch-disconnector

**Application Areas**

Perimeter: *Global*

Staff Function: -

Service Function: -

Business Line: *Infrastructure & Networks*

## 7. DESCRIPTION

### 7.1 LIST OF COMPONENTS

Type code	Description	Busbar VDS	Command type	Rated normal current [A]	Rated short circuit withstand current [kA]	Rated voltage [kV]
GSM001/1	2L+1T	YES	ELECTRICAL	630	16	24
GSM001/2	3L+1T	YES	ELECTRICAL	630	16	24
GSM001/3	3L	YES	ELECTRICAL	630	16	24
GSM001/4	4L+1T	YES	ELECTRICAL	630	16	24
GSM001/5	4L	YES	ELECTRICAL	630	16	24
GSM001/6	2L+1T	NO	ELECTRICAL	630	16	24
GSM001/7	3L+1T	NO	ELECTRICAL	630	16	24
GSM001/8	2L+2T	NO	ELECTRICAL	630	16	24
GSM001/9	3L	NO	ELECTRICAL	630	16	24
GSM001/10	1L	NO	ELECTRICAL	630	16	24
GSM001/16	1T	NO	MANUAL	630	16	24
GSM001/17	2L+1T	NO	ELECTRICAL	630	20	24
GSM001/18	3L+1T	NO	ELECTRICAL	630	20	24
GSM001/19	2L+2T	NO	ELECTRICAL	630	20	24
GSM001/20	3L	NO	ELECTRICAL	630	20	24
GSM001/21	1L	NO	ELECTRICAL	630	20	24
GSM001/26	1T	NO	MANUAL	630	20	24
GSM001/46	1L+1T	NO	ELECTRICAL	630	16	24

Table 1 - List of components (24 kV)

Type code	Description	Busbar VDS	Command type	Rated normal Current [A]	Rated short circuit withstand current [kA]	Rated voltage [kV]
GSM001/27	2L+1T	NO	ELECTRICAL	630	16	36
GSM001/28	3L+1T	NO	ELECTRICAL	630	16	36
GSM001/29	2L+2T	NO	ELECTRICAL	630	16	36
GSM001/30	1L	NO	ELECTRICAL	630	16	36
GSM001/35	1T	NO	MANUAL	630	16	36
GSM001/36	2L+1T	NO	ELECTRICAL	630	20	36
GSM001/37	3L+1T	NO	ELECTRICAL	630	20	36
GSM001/38	2L+2T	NO	ELECTRICAL	630	20	36
GSM001/39	3L	NO	ELECTRICAL	630	20	36
GSM001/40	1L	NO	ELECTRICAL	630	20	36
GSM001/45	1T	NO	MANUAL	630	20	36

Table 2 - List of components (36 kV)

**Technical Specification code: MAT-E&C-NC-2021-0052-EGIN**

Version no. 2 dated 08/07/2021

**Subject:** Global Infrastructure and Networks – GSM001 - MV RMU with switch-disconnector

**Application Areas**
Perimeter: *Global*

Staff Function: -

Service Function: -

Business Line: *Infrastructure & Networks*

Type code	Description	Busbar VDS	Command type	Rated normal current [A]	Rated short circuit withstand current [kA]	Rated voltage [kV]
GSM001/47	3L	NO	ELECTRICAL	630	20	24
GSM001/48	2L+1T	NO	ELECTRICAL	630	20	24
GSM001/49	2L+1T	YES	ELECTRICAL	630	16	24

**Table 3 - List of components - Alternative gas (24 kV SF6 free)**

For local component codification, see Annex C.

## 7.2 APPLICABLE LAWS AND REFERENCE STANDARDS

### Reference Laws

#### Colombia

The RMU must comply with the requirements established in the “Anexo General del RETIE Resolución 9 0708 de Agosto 30 de 2013 con sus Ajustes” and demonstrate this by means of a Certificate of Product Conformity.

#### Spain

The RMU must comply with the “Reglamento sobre condiciones técnicas y garantías de seguridad en instalaciones eléctricas de alta tensión y sus Instrucciones Técnicas Complementarias ITC-RAT 01 a 23 (R.D. 337/2014, de 9 de mayo)”, and consequently each RMU must be supplied accompanied by the "Declaración de Conformidad " required by this regulation, and the manufacturer or his authorized representative established in the European Union must keep the required “Expediente técnico” at disposal of the Spanish national market surveillance authority for inspection up to at least five years from the last date of manufacture of the product.

### International Standards

The listed reference documents shall be intended in the in-force edition at the TCA date (amendments and errata corrige included). Unless otherwise specified, these documents are valid until the new editions replace them. The terms used in this document are according to the standards listed below.

**Technical Specification code: MAT-E&C-NC-2021-0052-EGIN**

Version no. 2 dated 08/07/2021

**Subject:** Global Infrastructure and Networks – GSM001 - MV RMU with switch-disconnector

**Application Areas**
Perimeter: *Global*

Staff Function: -

Service Function: -

Business Line: *Infrastructure & Networks*

IEC 62271-1	High-voltage switchgear and controlgear - Part 1: Common specifications for alternating current switchgear and controlgear.
IEC 62271-102	High-voltage switchgear and controlgear - Part 102: Alternating current disconnectors and earthing switches.
IEC 62271-103	High-voltage switchgear and controlgear - Part 103: Switches for rated voltages above 1 kV up to and including 52 kV.
IEC 62271-105	High-voltage switchgear and controlgear - Part 105: Alternating current switch-fuse combinations for rated voltages above 1 kV up to and including 52 kV.
IEC 62271-200	High-voltage switchgear and controlgear - Part 200: AC metal-enclosed switchgear and controlgear for rated voltages above 1 kV and up to and including 52 kV.
IEC TS 62271-210	High-voltage switchgear and controlgear - Part 210: Seismic qualification for metal enclosed and solid-insulation enclosed switchgear and controlgear assemblies for rated voltages above 1 kV and up to and including 52 kV.
IEC 61243-5	Live working - Voltage detectors - Part 5: Voltage detecting systems (VDS).
IEC 60282-1	High-voltage fuses - Part 1: Current-limiting fuses.
IEC 60447	Basic and safety principles for man-machine interface, marking and identification - Actuating principles.
IEC 60529	Degrees of protection provided by enclosures (IP Code).
IEC 60068-2-52	Environmental testing – Part 2-52: Tests – Test Kb: Salt mist, cyclic (sodium chloride solution).
ISO 12944	Paints and varnishes — Corrosion protection of steel structures by protective paint systems.
ISO 2409	Paints and varnishes — Cross-cut test.
IEC 60137	Insulated bushings for alternating voltages above 1000 V
EN 50181	Plug-in type bushings above 1 kV up to 52 kV and from 250 A to 2,50 kA for equipment other than liquid filled transformers
ISO 4042	Fasteners - Electroplated coatings

**ENEL Technical Standards**

GSCC006	12/20(24) kV and 18/30(36) kV Separable connectors for MV cables.
GSCT005	Technical characteristics of LPITs for RGDM/RGDAT.
PVR006	Barcode.

**Colombian Technical Standards**



**Technical Specification code: MAT-E&C-NC-2021-0052-EGIN**

Version no. 2 dated 08/07/2021

**Subject:** Global Infrastructure and Networks – GSM001 - MV RMU with switch-disconnector

**Application Areas**
Perimeter: *Global*

Staff Function: -

Service Function: -

Business Line: *Infrastructure & Networks*

NSR-10

Requisitos generales de diseño y construcción sismo resistente.

### 7.3 SERVICE CONDITIONS

Clause 2 of IEC 62271-200 is applicable with the following addition:

Minimum ambient air temperature for indoor switchgear	- 15 °C
Network neutral earthing systems	Effectively earthed neutral system Non effectively earthed neutral system
Maximum reference altitude	1.500 m
Maximum reference altitude for Colombia	2.700 m

**Table 4 – Service conditions**

Seismic qualification level: Severity level 1 – PGA 0,5 g.

Acceptance class 2 according to IEC TS 62271-210.

### 7.4 TECHNICAL CHARACTERISTICS

#### Switchgear characteristics

The switchgear shall be compliant with IEC 62271-200. The solution for the insulation of the switchgear is SF6. However, gas alternative to SF6 can be considered and is subject to Enel approval.

The switchgear shall be a sealed pressure system (IEC 62271-200).

The gas-filled compartment shall have a SF6 volume less than 1500 liters and its filling, to be implemented exclusively in the factory, shall be made in order that the maximum operating relative pressure at 45 °C does not exceed 0,5 kg/cm<sup>2</sup> (49,033 kpa).

The elements used in the factory for filling and recovering the SF6 at the end of life (if present) shall be identified with a self-adhesive plate and protected from accidental shocks. On the plate it shall be written in the language of the country to which it will be supplied: "Remove the cap at the end of the switchgear's operating life only for the possible recovery of gas". This plate shall have a yellow RAL 1021 background and the words in black RAL 9005.

**Technical Specification code: MAT-E&C-NC-2021-0052-EGIN**

Version no. 2 dated 08/07/2021

**Subject:** Global Infrastructure and Networks – GSM001 - MV RMU with switch-disconnector**Application Areas**Perimeter: *Global*

Staff Function: -

Service Function: -

Business Line: *Infrastructure & Networks*

---

Modular units shall be designed to be attached along the busbars. Solution based in connectors placed in the upper part of the units are not allowed.

The compact RMU can be made in a single SF6 insulated tank containing the busbars, the switching devices and their interconnections or from modular units assembled along the busbars by means of insulated connectors.

In case of a compact RMU is composed of several modular units attached, the manufacturer must supply the equipment in a way that it is possible to be transported, handled and installed as if it were, in any case, made in a single SF6 insulated tank. In this situation, the insulated connectors must not be accessible, conforming an ingress protection class IP3X.

Every gas-filled compartment shall have an overpressure valve, equipped with a metallic disc for the protection against accidental strains and placed at a proper distance from the valve itself. The gas expulsion from the expansion valve shall be directed to the trench.

To connect the MV cable connectors, the switchgear shall be equipped with external plug-in type bushings according to EN 50181, with capacitive voltage divider for the supply of the voltage detection system and Low Power Voltage Transformer (according to ENEL Standard GSCT005) for voltage measurement. Bushings shall have a 630 A rated normal current for the line unit (type C interface, according to EN 50181) and 250 A rated normal current for the transformer unit (type A interface for 24 kV switchgears and type B interface for 36 kV switchgears, according to EN 50181).

**Technical Specification code: MAT-E&C-NC-2021-0052-EGIN**

Version no. 2 dated 08/07/2021

**Subject:** Global Infrastructure and Networks – GSM001 - MV RMU with switch-disconnector

**Application Areas**
Perimeter: *Global*

Staff Function: -

Service Function: -

Business Line: *Infrastructure & Networks*
**Rated characteristics**

Rated Voltage		[kV]	24	36
Rated insulation level	Rated short-duration power-frequency withstand voltage – Common value	[kV]	50	70
	Rated short-duration power-frequency withstand voltage – Across the isolating distance	[kV]	60	80
	Rated lightning impulse withstand voltage – Common value	[kV]	125	170
	Rated lightning impulse withstand voltage - Across the isolating distance	[kV]	145	195
Rated frequency (*)		[Hz]	50 (and 60)	
Rated normal current:				
	- for busbars and lines	[A]	630	
	- for transformer derivation	[A]	200	
Rated short-time withstand current		[kA]	16/20	
Rated peak withstand current		[kA]	40 (and 41,6) / 50 (and 52)	
Rated duration of short-circuit		[s]	1	
Degree of protection for the whole enclosure except for the operating devices:				
	- Argentina			IP3X
	- Italy			
	- Romania			
	- Spain			
	- Brazil			IP51
	- Chile			
	- Colombia			
	- Peru			
Degree of protection for the operating devices (even with the operating lever inserted)			IP2XC	
Degree of protection of the external part of the switchgear			IK08	
Internal arc test	Type of accessibility		AFL	
	Rated arc fault current	[kA]	16/20	
	Rated arc fault duration	[s]	1	
Rated supply voltage of closing and opening devices and of auxiliary circuit		[Vcc]	24V -15% +20%	
Expected operating life regarding leakage performance			40 years	

**Table 5 – Characteristics of the switchgear**

(\*) The range of rated frequencies can vary according to the National Regulations and shall not affect the proper behavior of the equipment.

**Subject:** Global Infrastructure and Networks – GSM001 - MV RMU with switch-disconnector

**Application Areas**

Perimeter: *Global*

Staff Function: -

Service Function: -

Business Line: *Infrastructure & Networks*

## Functional schemes

The general functional electric schemes of each unit are displayed in Figure 1.

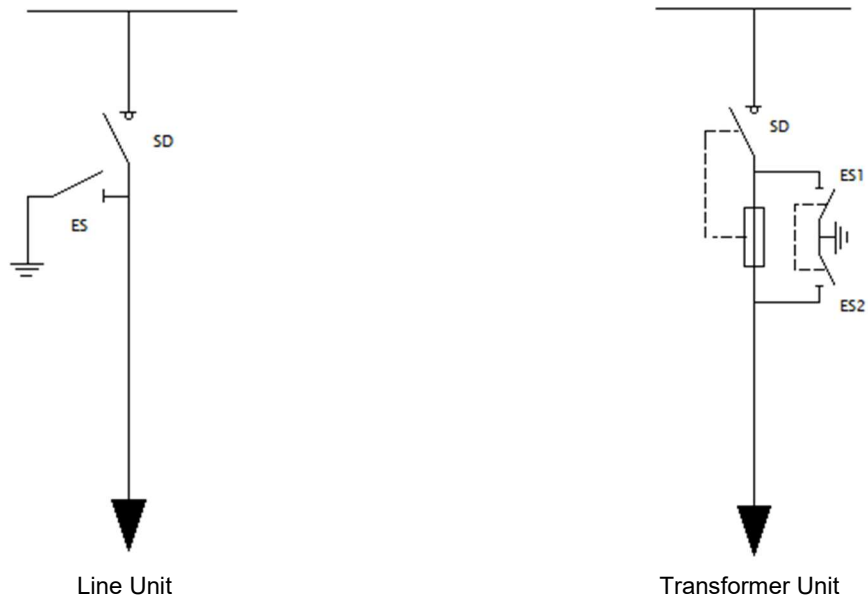

**Figure 1 – Functional schemes**

## Constructive solution

The functional schemes described in the previous chapter can be implemented by the following constructive solutions given as example:

**Subject:** Global Infrastructure and Networks – GSM001 - MV RMU with switch-disconnector

**Application Areas**

Perimeter: *Global*

Staff Function: -

Service Function: -

Business Line: *Infrastructure & Networks*

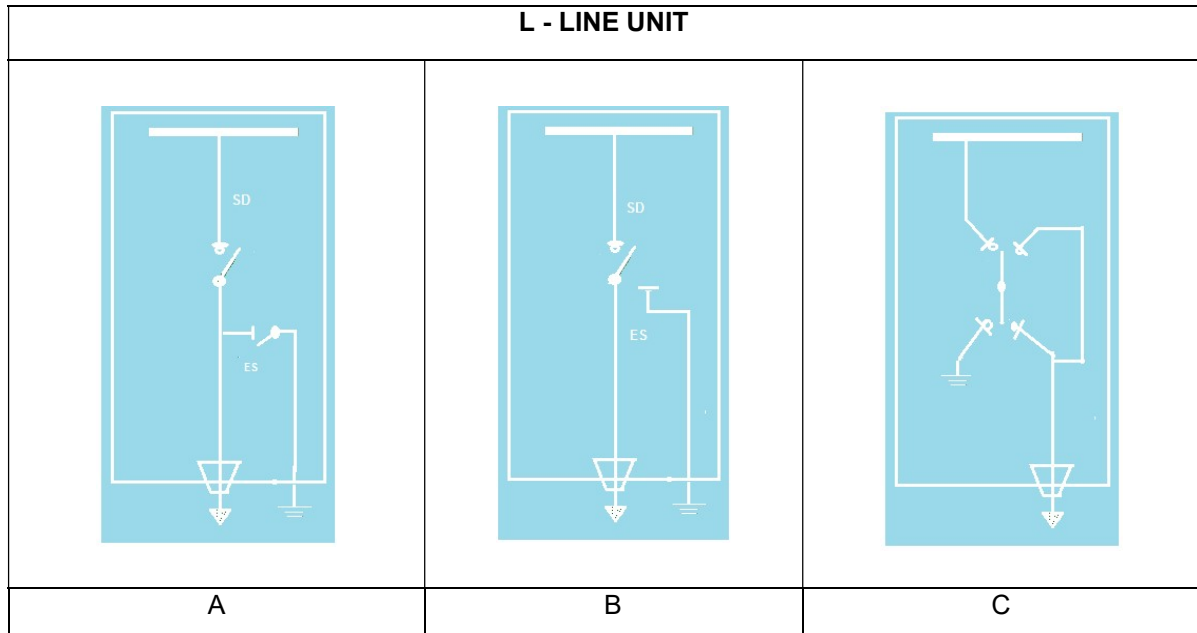

**RMU Possible constructive solutions for L unit electrical scheme**

OPTION A: Configuration with

1 Switch-disconnector with 2 position (OPEN – CLOSED)

1 Earthing switch with 2 positions (OPEN – EARTHED)

OPTION B/C: Configuration with

1 Switch-disconnector / Earthing switch with 3 positions (EARTHED - OPEN – CLOSED)

**Subject:** Global Infrastructure and Networks – GSM001 - MV RMU with switch-disconnector

**Application Areas**

Perimeter: *Global*

Staff Function: -

Service Function: -

Business Line: *Infrastructure & Networks*

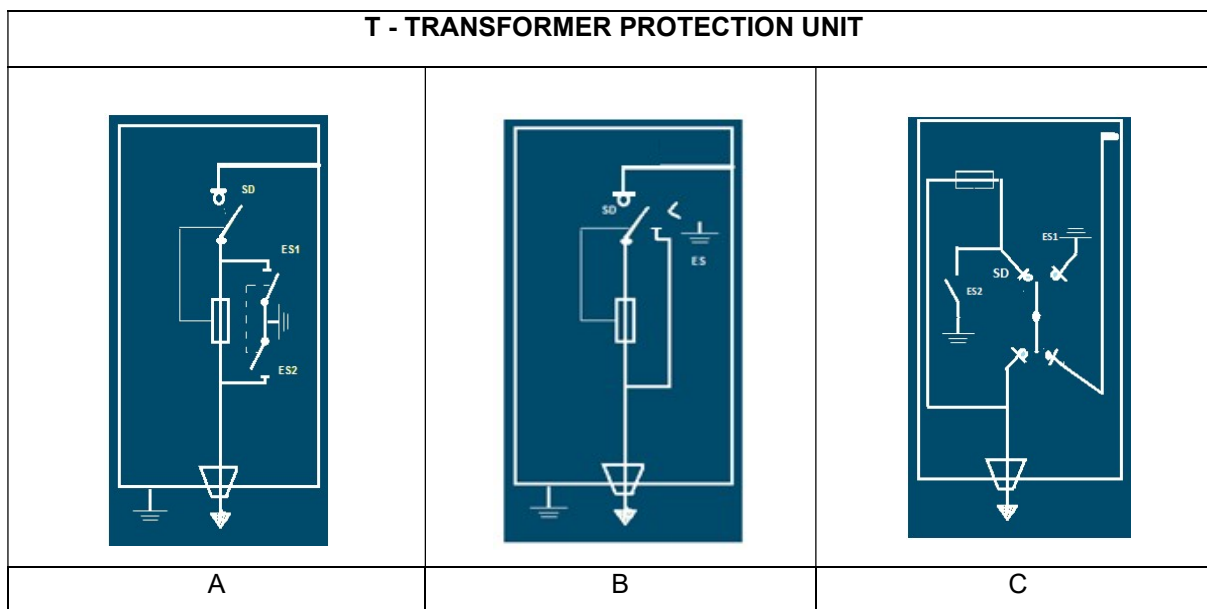

**Possible constructive solutions for T unit electrical scheme**

OPTION A/B : Configuration with

- 1 Switch-disconnector with 2 position (OPEN – CLOSED)
- 2 Earthing switches (ES1/ES2) with 2 positions (OPEN – EARTHED)

OPTION B/C: Configuration with

- 1 Switch-disconnector / Earthing switch (ES) with 3 positions (EARTHED - OPEN – CLOSED)

The functional schemes displayed in Figure 1 can be implemented by several means. The constructive solution of the switchgear shall be approved by the Standardization Unit of ENEL

## SF6

The characteristics of the first filling gas shall meet the requirements of IEC 60376. The humidity content of the first filling gas shall be less than 15 ppm in weight and, during operation, the absence of condensation at the minimum operating expected temperatures must be guaranteed. The manufacturer shall ensure that at the end of the expected operating life of the equipment, the gas pressure remains greater than (or equal) the minimum operating pressure pm (minimum necessary pressure to ensure the performances prescribed for the device). In any case, the loss shall not exceed the 0.1% value in weight per year (IEC 62271-1).

For installations above 1.500 meters, the supplier must indicate the differences in the installation operating methods (if any).

**Technical Specification code: MAT-E&C-NC-2021-0052-EGIN**

Version no. 2 dated 08/07/2021

**Subject:** Global Infrastructure and Networks – GSM001 - MV RMU with switch-disconnector**Application Areas**Perimeter: *Global*

Staff Function: -

Service Function: -

Business Line: *Infrastructure & Networks*

---

## 7.5 CONSTRUCTION CHARACTERISTICS

### Line unit

The three-pole switch-disconnector and earthing switches must comply with IEC 62271-103 and IEC 62271-102 respectively.

The operating point of the earthing switch functionality must be separated from the operating point of the switch-disconnector functionality and interlocked with it.

The movement of the blades of the switching devices must be simultaneous.

The three-pole manual operating device of the switch-disconnectors must be dead-center overcoming both in opening and closing, vertical, rotational or translational movement (IEC 60447).

The operations must be performed by applying a moment that does not exceed 200 Nm, and the opening and closing speed must be independent of the action of the operator.

In case that switch-disconnectors and earthing switches are separated, the shaft of the earthing switch shall be mechanically interlocked with the shaft of the switch-disconnector.

### Rated characteristics

The rated characteristics of the switch–disconnector and the earthing switch are shown in table 5

**Technical Specification code: MAT-E&C-NC-2021-0052-EGIN**

Version no. 2 dated 08/07/2021

**Subject:** Global Infrastructure and Networks – GSM001 - MV RMU with switch-disconnector

**Application Areas**
Perimeter: *Global*

Staff Function: -

Service Function: -

Business Line: *Infrastructure & Networks*

<b>SWITCH-DISCONNECTORS</b>			
Rated Voltage	[kV]	24	36
Rated normal current	[A]	630	
Rated short-time withstand current	[kA]	16/20	
Rated peak withstand current	[kA]	40 (and 41,6) / 50 (and 52)	
Rated duration of short-circuit	[s]	1	
Mechanical endurance class		M1	
Electrical endurance class		E3	
Rated breaking current	of a mainly active load	[A]	630
	of a no-load line	[A]	1,5      2
	of a no-load cable	[A]	16      20
	in case of earth fault	[A]	60
	with cable-charging in case of earth fault	[A]	40
<b>EARTHING SWITCH</b>			
Rated Voltage	[kV]	24	36
Rated short-time withstand current	[kA]	16/20	
Crest value of the rated short-time withstand current	[kA]	40 (and 41,6) / 50 (and 52)	
Rated short-circuit duration	[s]	1	
Mechanical endurance class		M0	
Electrical endurance class		E2	

**Table 6 - Characteristics of the switch–disconnector and earthing switch in line unit**
**Line unit front panel**

The elements displayed on the front panel of the line unit shall be such as to make them easily visible, readable and accessible.

The front panel is divided in three areas:

- Switch-disconnector operation area.
- Earthing switch operation area.
- Common area.

All three areas shall be located in the same vertical than the related cable compartment.



**Subject:** Global Infrastructure and Networks – GSM001 - MV RMU with switch-disconnector

**Application Areas**

Perimeter: *Global*

Staff Function: -

Service Function: -

Business Line: *Infrastructure & Networks*

If the operation of the switchgear is vertically oriented, the order of the areas shall be, from top to bottom: Switch-disconnector operation area → Earthing switch operation area.

If the operation of the switchgear is horizontally oriented, the order of the areas shall be, from left to right: Switch-disconnector operation area → Earthing switch operation area.

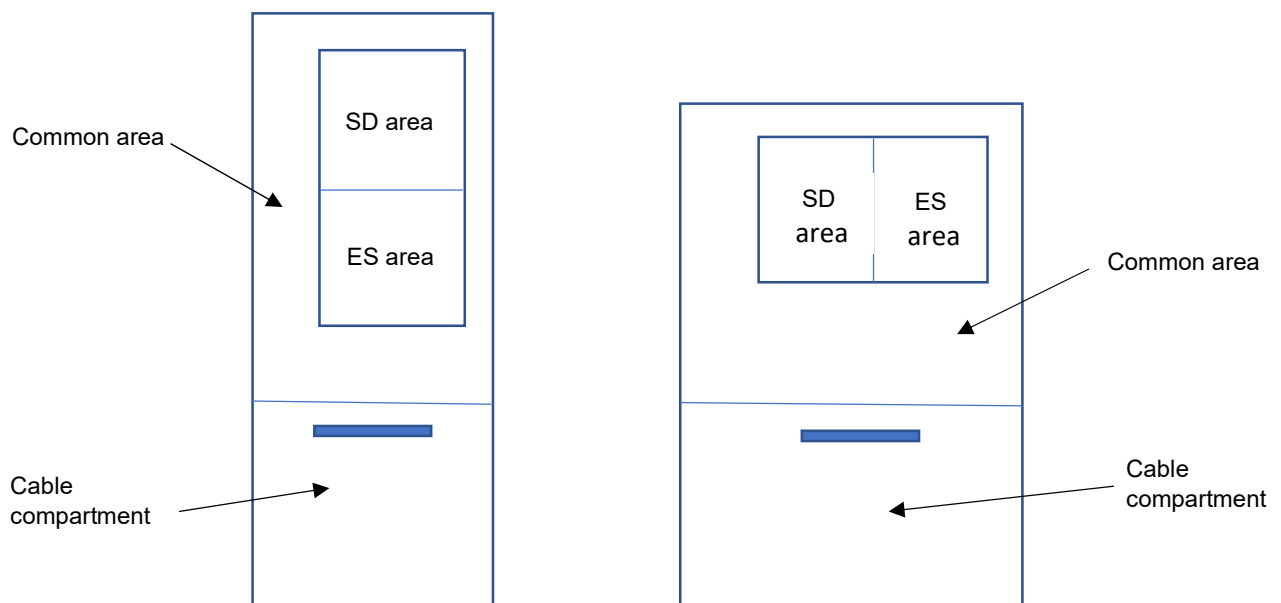

**Figure 2 – Disposition of areas in the front panel in line unit**

### Switch-disconnector operation area.

The background of the switch-disconnector area must be colored according to the RAL 5022-F2.

The switch-disconnector operation area is composed of the following elements:

- point for the operation of switch-disconnector, with indication of the operating directions in local language. The operating directions, according to IEC 60447, shall be displayed using the following colors:
  - red 3000 RAL-F2 color corresponding to the close direction of the switch-disconnector.
  - green 6017 RAL-F2 corresponding to the open direction of the switch-disconnector.

**Subject:** Global Infrastructure and Networks – GSM001 - MV RMU with switch-disconnector

**Application Areas**

Perimeter: *Global*

Staff Function: -

Service Function: -

Business Line: *Infrastructure & Networks*

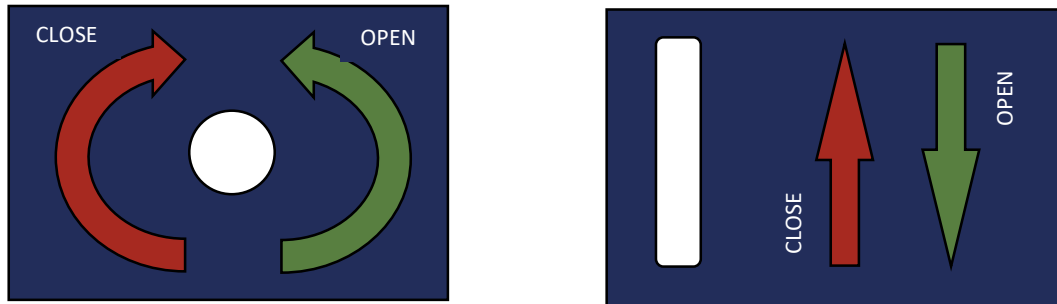

**Figure 3 – Point for the operation of switch-disconnector in line unit**

- Indicator showing the position of the switch-disconnector. The indicator shall be mechanically interconnected with the mobile power contacts and the position shall be displayed using the following symbols:
  - black "I" letter on red background 3000 RAL-F2 corresponding to the closed position of the switch-disconnector.
  - black "O" letter on green background 6017 RAL-F2 corresponding to the open position of the switch-disconnector.

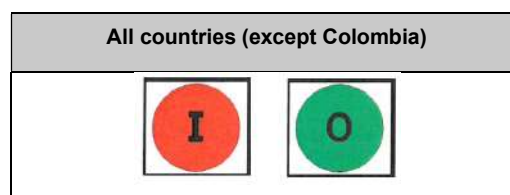

**Figure 4 – Indicator for the position of the switch-disconnector in line unit**

Exceptionally for Colombia the position shall be displayed using the following symbols:

- black "I" letter on green background 6017 RAL-F2 corresponding to the closed position of the switch-disconnector;
- black "O" letter on red background 3000 RAL-F2 corresponding to the open position of the switch-disconnector;

**Subject:** Global Infrastructure and Networks – GSM001 - MV RMU with switch-disconnector

**Application Areas**

Perimeter: *Global*

Staff Function: -

Service Function: -

Business Line: *Infrastructure & Networks*

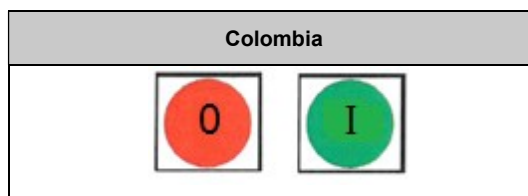

**Figure 5 – Indicator for the position of the switch-disconnector in line unit (Colombia)**

The indicators shall be visible even with the front panel removed.

The indicators must be protected by a transparent window that prevents the entry of foreign objects in order to prevent its indication from being altered by external manipulation.

- Two buttons for the electrical opening (green) and closing (red) operations in case of switchgears with electric command. The buttons shall be protected to avoid accidental touch and shall have a nameplate indicating their performed function (open / close) in the language that corresponds to the Country in which the switchgear will be delivered.

- Switch to enable/disable the motorized electrical operation (both from local buttons and from remote control). The switch shall be lockable and will allow the insertion of a padlock with a shackle up to 6 mm in diameter. The lockable point shall be signaled by a “padlock” symbol.

The switch shall have a nameplate indicating its function in the language that corresponds to the Country in which the switchgear will be delivered.

In addition, next to the switch, there will be the indications O Off (motor disabled) and I ON (motor enabled).



**Figure 6 – Example of switch to enable/disable the electrical operation in line unit**

### Earthing switch operation area

The background of the earthing switch area must be colored according to RAL 1015-F2.

The earthing switch operation area is composed of the following elements:

**Subject:** Global Infrastructure and Networks – GSM001 - MV RMU with switch-disconnector

**Application Areas**

Perimeter: *Global*

Staff Function: -

Service Function: -

Business Line: *Infrastructure & Networks*

- point for operation of the earthing switch, with indication of the operating directions in local language. The operating directions, according to IEC 60447, shall be displayed using the following colors:
  - yellow color 1021 RAL-F2 corresponding to the close direction of the earthing switch.
  - gray color 7030 RAL-F2 corresponding to the open direction of the earthing switch.

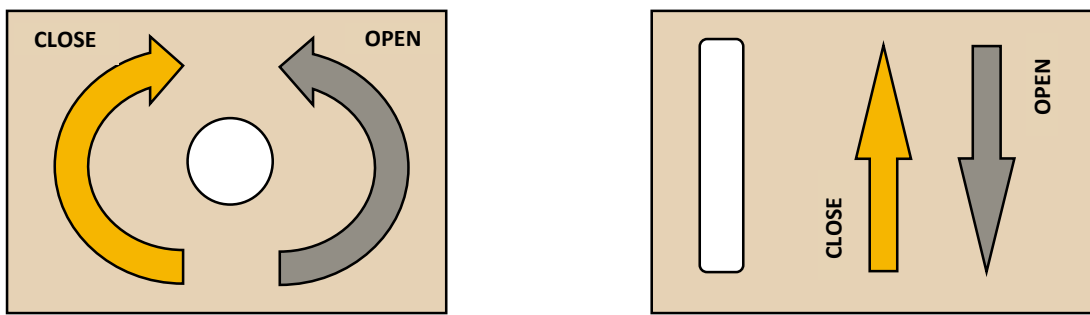

**Figure 7 – Point for the operation of earthing switch in line unit**

- Indicator showing the position of the earthing switch. The indicator shall be mechanically interconnected with the mobile power contacts and the position shall be displayed using the following symbols:
  - black "I" letter on yellow background 1021 RAL-F2 corresponding to the closed position of the earthing switch.
  - black "O" letter on gray background 7030 RAL-F2 corresponding to the open position of the earthing switch.

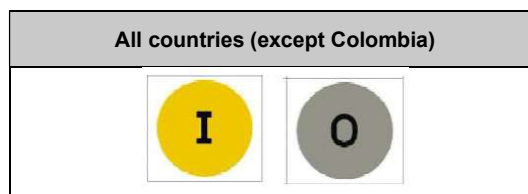

**Figure 8 – Indicator for the position of the earthing switch in line unit**

Exceptionally for Colombia the position shall be displayed using the following symbols:

**Subject:** Global Infrastructure and Networks – GSM001 - MV RMU with switch-disconnector

**Application Areas**

Perimeter: *Global*

Staff Function: -

Service Function: -

Business Line: *Infrastructure & Networks*

- black "I" letter on green background 6017 RAL-F2 corresponding to the closed position of the switch-disconnector.
- black "O" letter on red background 3000 RAL-F2 corresponding to the open position of the switch-disconnector.

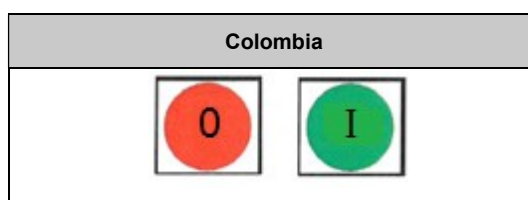

**Figure 9 – Indicator for the position of the earthing switch in line unit (Colombia)**

The indicators shall be visible even with the front panel removed.

The indicators must be protected by a transparent window that prevents the entry of foreign objects in order to prevent its indication from being altered by external manipulation.

### Common area

The common area of the front panel is the part of the front panel that contains the elements defined in the switch-disconnector area and the earthing switch area.

In the common area are located the following elements:

- Voltage detection system (VDS), according to chapter 7.7
- Manometer, if necessary, according to chapter 7.3
- Rating plate according to chapter 7.12.1, if the line unit is modular. In case the line unit is a part of a compact RMU, the rating plate can be attached to any functional unit.
- Operating sequence nameplate, according to chapter 7.12.2
- Synoptic scheme, according to chapter 7.12.2
- Label holder, according to chapter 7.12.5

### Interlocking

The sequence of operations to close the line output shall be:

1. opening of the earthing switch.
2. closing the switch-disconnector.

The sequence of operations to open the line output in safe condition shall be:

1. opening of the switch-disconnector.
2. closing the earthing switch.

**Technical Specification code: MAT-E&C-NC-2021-0052-EGIN**

Version no. 2 dated 08/07/2021

**Subject:** Global Infrastructure and Networks – GSM001 - MV RMU with switch-disconnector**Application Areas**Perimeter: *Global*

Staff Function: -

Service Function: -

Business Line: *Infrastructure & Networks*

It will only be possible to operate the switch-disconnector when the earthing switch is in the open position and the access door of the cable compartment is closed. An electrical interlock will allow the motor to operate only when the earthing blades are completely open.

It will only be possible to operate the earthing switch when the switch-disconnector is in the open position and with the access door of the cable compartment closed.

The switch-disconnector and the earthing switch must not be concurrently closed.

Two points must be provided where a padlock can be inserted to lock the manual operation of the switch-disconnector and of the earthing switch in an independent way, in both open and closed positions. They will allow the insertion of a padlock with a shackle up to 6 mm in diameter. These points shall be signaled by a “padlock” symbol

It must be possible to lock the electrical operation of the switch-disconnector through the switch indicated in section 5.2.2.

The insertion of the command lever in the switch-disconnector operation point or in the earthing switch operation point must prevent the motorized operation of the switch-disconnector. This interlock must have act before the end of the lever engages on the operating shaft. This condition can be achieved both with a mechanical mechanism (decoupling of the motor) or with an electric solution (cutting motor power supply).

The access door of the cable compartment must be removed only in safe condition, with the switch-disconnector open and earthing switch closed. This condition must be achieved with a mechanical interlock.

With the access door removed, an electrical interlock must prevent the electrical operation of the switch-disconnector and a mechanical interlock must prevent the mechanical operation of both, the switch-disconnector and the earthing switch.

For the purpose of cable testing, with the access door removed, the interlock of the earthing switch may be bypassed only using a screwdriver. The mechanical and electrical interlock of the switch-disconnector must remain in any case. This bypass system must be designed in such a way that each time a closing operation of the earthing switch is executed, the interlock returns to its normal situation. See Annex A for the list for the interlocks checking.

### **Transformer unit characteristics**

The manual switch-disconnector (SD) combined with fuses, for the MV / LV transformer protection, shall comply with IEC 62271-105 and IEC 62271-103

### **Rated characteristics**

**Subject:** Global Infrastructure and Networks – GSM001 - MV RMU with switch-disconnector

**Application Areas**

Perimeter: *Global*

Staff Function: -

Service Function: -

Business Line: *Infrastructure & Networks*

<b>Switch-disconnector</b>			
Rated voltage	[kV]	24	36
Rated normal current	[A]	200	
Rated short-time withstand current	[kA]	16/20	
Rated peak withstand current	[kA]	40 (and 41,6) / 50 (and 52)	
Rated duration of short-circuit	[s]	1	
Mechanical endurance class		M1	
Electrical endurance class		E3	
<b>Earthing switches ES1 or ES (see figure 1)</b>			
Rated short-time withstand current	[kA]	16/20	
Rated peak withstand current	[kA]	40 (and 41,6) / 50 (and 52)	
Rated short-circuit duration	[s]	1	
Mechanical endurance class		M0	
Electrical endurance class		E2	
<b>Earthing switch ES2 (see figure 1)</b>			
Rated short-time withstand current	[kA]	1	
Rated peak withstand current	[kA]	2,5	
Rated short-circuit duration	[s]	1	
Mechanical endurance class		M0	
Electrical endurance class		E2	

**Table 7 - Characteristics of the switch–disconnector and earthing switches in transformer unit**

To show the open position of the switch-disconnector, a micro-switch shall be provided. This micro-switch shall be put inside the operating device protective shell and shall be able to switch small currents. This micro-switch must be connected to a 2x1.5 mm<sup>2</sup> LV cable with a length of 8 m that protrudes from the switchgear. This cable should be correspondingly identified.

The connection must have a faston with cable end sleeves as shown in the figure 10.



**Figure 10 – Faston with cable end sleeves**

## Transformer unit front panel

**Subject:** Global Infrastructure and Networks – GSM001 - MV RMU with switch-disconnector

**Application Areas**

Perimeter: *Global*

Staff Function: -

Service Function: -

Business Line: *Infrastructure & Networks*

The elements displayed on the front panel of the transformer unit shall be such as to make them easily visible, readable and accessible.

The front panel is divided in three areas:

- Switch-disconnector operation area.
- Earthing switch operation area.
- Common area.

All three areas shall be in the same vertical than the cable compartment.

If the operation of the switchgear is vertically oriented, the order of the areas shall be, from top to bottom:

Switch-disconnector operation area → Earthing switch operation area

If the operation of the switchgear is horizontally oriented, the order of the areas shall be, from left to right:

Switch-disconnector operation area → Earthing switch operation area

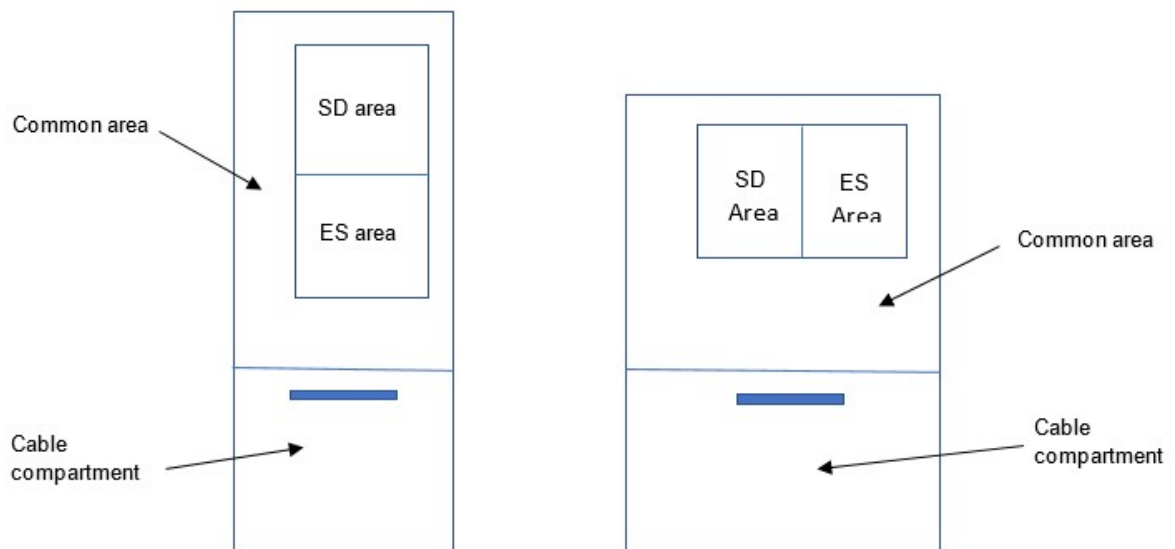

**Figure 11 – Disposition of areas in the front panel in transformer unit**

### **Switch-disconnector operation area.**

The background of the switch-disconnector area must be colored according to RAL 5022-F2.

The switch-disconnector operation area is composed of the following elements:



**Subject:** Global Infrastructure and Networks – GSM001 - MV RMU with switch-disconnector

**Application Areas**

Perimeter: *Global*

Staff Function: -

Service Function: -

Business Line: *Infrastructure & Networks*

- point for the operation of switch-disconnector / spring charger, with indication of the operating directions in local language. The operating directions, according to IEC 60447, shall be displayed using the following colors:
  - red 3000 RAL-F2 color corresponding to the close direction of the switch-disconnector.
  - green 6017 RAL-F2 corresponding to the open direction of the switch-disconnector.

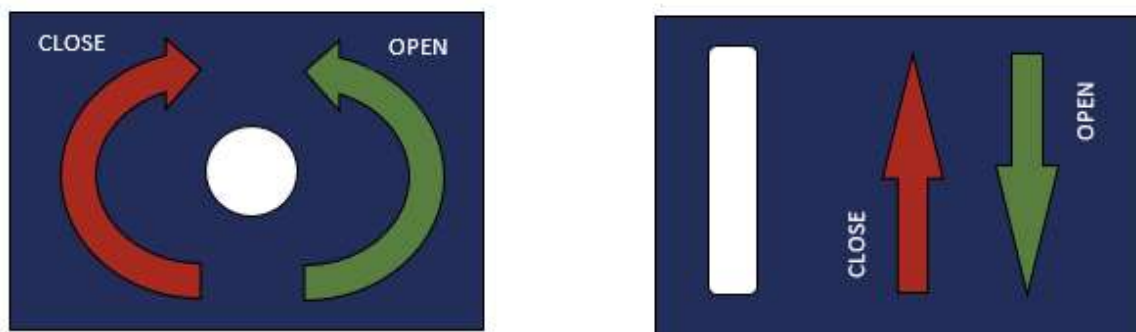

**Figure 12 – Point for the operation of switch-disconnector in transformer unit**

The opening of the switch-disconnector by means of a release spring energy device is also accepted.

Other alternative operation solutions based on buttons will be considered, subject to Enel approval.

- Indicator showing the position of the switch-disconnector. The indicator shall be mechanically interconnected with the mobile power contacts and the position shall be displayed using the following symbols:
  - black "I" letter on red background 3000 RAL-F2 corresponding to the closed position of the switch-disconnector;
  - black "O" letter on green background 6017 RAL-F2 corresponding to the open position of the switch-disconnector;

**Subject:** Global Infrastructure and Networks – GSM001 - MV RMU with switch-disconnector

**Application Areas**

Perimeter: *Global*

Staff Function: -

Service Function: -

Business Line: *Infrastructure & Networks*

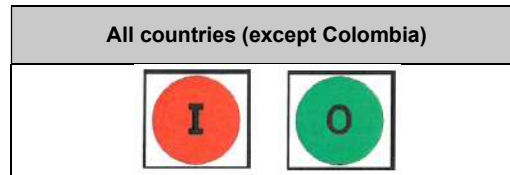

**Figure 13 – Indicator for the position of the switch-disconnector in transformer unit**

Exceptionally for Colombia the position shall be displayed using the following symbols:

- black "I" letter on green background 6017 RAL-F2 corresponding to the closed position of the switch-disconnector;
- black "O" letter on red background 3000 RAL-F2 corresponding to the open position of the switch-disconnector;

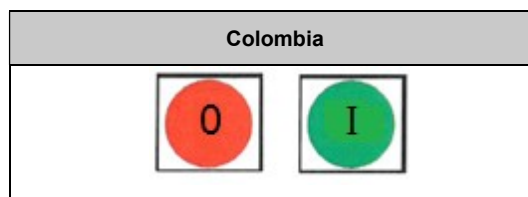

**Figure 14 – Indicator for the position of the switch-disconnector in transformer unit (Colombia)**

The indicators shall be visible even with the front panel removed.

The indicators must be protected by a transparent window that prevents the entry of foreign objects in order to prevent its indication from being altered by external manipulation.

### **Earthing switch operation area.**

The background of the earthing switch area must be colored according to RAL 1015-F2.

The earthing switch operation area is composed of the following elements:

- point for operation of the earthing switch, with indication of the operating directions in local language. The operating directions, according to IEC 60447, shall be displayed using the following colors:

**Subject:** Global Infrastructure and Networks – GSM001 - MV RMU with switch-disconnector

**Application Areas**

Perimeter: *Global*

Staff Function: -

Service Function: -

Business Line: *Infrastructure & Networks*

- yellow color 1021 RAL-F2 corresponding to the close direction of the earthing switch;
- gray color 7030 RAL-F2 corresponding to the open direction of the earthing switch;

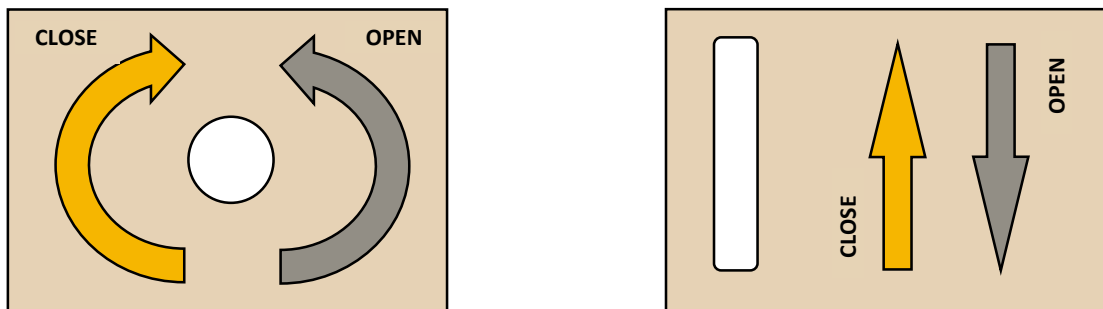

**Figure 15 – Point for the operation of earthing switch in transformer unit**

- Indicator showing the position of the earthing switch. The indicator shall be mechanically interconnected with the mobile power contacts and the position shall be displayed using the following symbols:
  - black "I" letter on yellow background 1021 RAL-F2 corresponding to the closed position of the earthing switch;
  - black "O" letter on gray background 7030 RAL-F2 corresponding to the open position of the earthing switch;

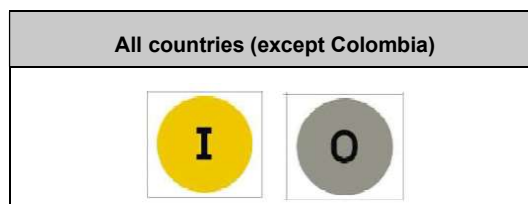

**Figure 16 – Indicator for the position of the earthing switch in transformer unit**

Exceptionally for Colombia the position shall be displayed using the following symbols:

- black "I" letter on green background 6017 RAL-F2 corresponding to the closed position of the switch-disconnector;
- black "O" letter on red background 3000 RAL-F2 corresponding to the open position of the switch-disconnector;



**Technical Specification code: MAT-E&C-NC-2021-0052-EGIN**

Version no. 2 dated 08/07/2021

**Subject:** Global Infrastructure and Networks – GSM001 - MV RMU with switch-disconnector

**Application Areas**

Perimeter: *Global*

Staff Function: -

Service Function: -

Business Line: *Infrastructure & Networks*

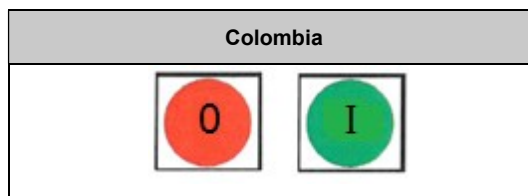

**Figure 17 – Indicator for the position of the earthing switch in transformer unit (Colombia)**

The indicators shall be visible even with the front panel removed.

The indicators must be protected by a transparent window that prevents the entry of foreign objects in order to prevent its indication from being altered by external manipulation.

### Common area

The common area of the front panel is the part of the front panel that contains the elements defined in the switch-disconnector area and the earthing-switch area.

In the common area are located the following elements:

- fuse status indicator, with the following symbols:
  - green indicator: All fuses are operatives
  - red indicator: One or more fuses are melted.

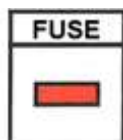

**Figure 18 - Example of indicator showing one or more melted fuses**

The fuse indicator must be protected by a transparent window that prevents the entry of foreign objects in order to prevent its indication from being altered by external manipulation.

**Technical Specification code: MAT-E&C-NC-2021-0052-EGIN**

Version no. 2 dated 08/07/2021

**Subject:** Global Infrastructure and Networks – GSM001 - MV RMU with switch-disconnector**Application Areas**Perimeter: *Global*

Staff Function: -

Service Function: -

Business Line: *Infrastructure & Networks*

---

- Voltage detection system (VDS), according to chapter 7.7
- Manometer, if necessary, according to chapter 7.3
- Rating plate according to chapter 7.12.1, if the transformer unit is modular. In case the transformer unit is a part of a compact RMU, the rating plate can be attached to any functional unit.
- Operating sequence nameplate, according to chapter 7.12.2
- Synoptic scheme, according to chapter 7.12.2
- Label holder, according to chapter 7.12.5

## Interlocking

The sequence of operations to close the transformer output shall be:

1. opening of the earthing switches.
2. closing the switch-disconnector.

The sequence of operations to open the transformer output (safe condition) shall be:

1. opening of the switch-disconnector.
2. closing the earthing switches.

It will only be possible to operate the switch-disconnector when the earthing switches are in the open position and with the access door of the cable compartment and the transformer fuse compartment closed.

It will only be possible to operate the earthing switches when the switch-disconnector is in the open position and with the access door of the cable compartment and the transformer fuse compartment closed.

The switch-disconnector and the earthing switches must not be concurrently closed.

Two points must be provided where a padlock can be inserted to lock the operation of the switch-disconnector and of the earthing switches in an independent way, in both open and closed positions. They will allow the insertion of a padlock with a shackle up to 6 mm in diameter. These points should be signalized by a “padlock” symbol.

The access door of the cable compartment and the transformer fuse compartment must be removed only in safe condition, with the switch-disconnector open and earthing switches closed. This condition must be achieved with a mechanical interlock.

**Subject:** Global Infrastructure and Networks – GSM001 - MV RMU with switch-disconnector

**Application Areas**

Perimeter: *Global*

Staff Function: -

Service Function: -

Business Line: *Infrastructure & Networks*

When the switch-disconnector is opened for fuse tripping, the switch-disconnector must be ready to do the spring charging and the closing operation in one single maneuver, without intermediate operations

The intervention of one or more fuses shall cause the opening of the switch-disconnector

See Annex A for the list for the interlocks checking.

### Fuse-carriers and fuses

The fuse-carrier is composed by a container made of insulating material having an appropriate closing device that ensures the protection against dust pollutants with a degree of protection IP4X.

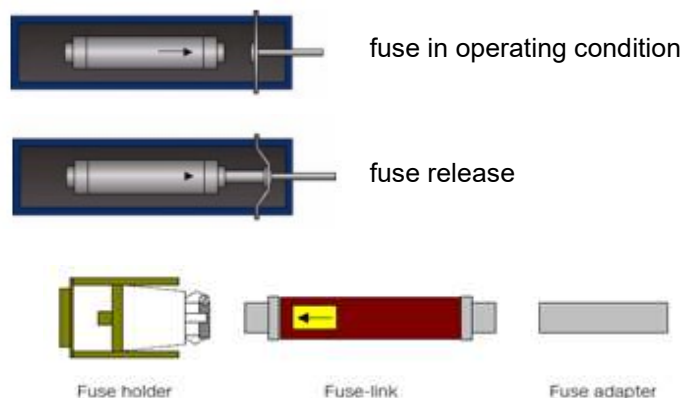

**Figure 19 – Fuse and operation scheme**

The MV fuse holder, which must be protected by a metal compartment, can be installed inside the terminal compartment or outside the gas-filled compartment.

The opening of the fuse-holder shall always happen at a pressure which is not dangerous for the operator. For this purpose, the opening of the fuse-holder shall be done in two steps, one first step that breaks the tightness and releases any possible overpressure, keeping the fuse mechanically attached to the switchgear, and a second step that releases the fuse and allows its complete extraction.

The fuse-carrier shall have dimensions that are suitable to the use of fuses with maximum rated voltage of 12 kV, 17.5 kV, 24 kV and 36 kV. In case of fuses with a rated voltage other than 24 kV or 36 kV, an appropriate adapter must be provided.

**Subject:** Global Infrastructure and Networks – GSM001 - MV RMU with switch-disconnector

**Application Areas**

Perimeter: *Global*

Staff Function: -

Service Function: -

Business Line: *Infrastructure & Networks*

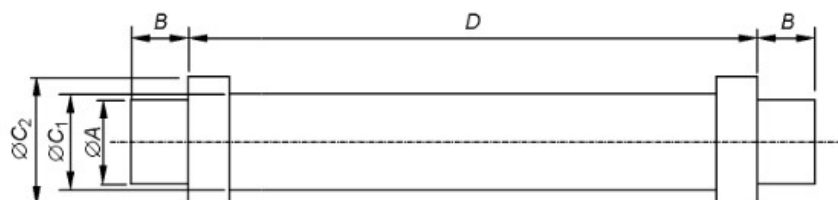

The striker shall be on the centre-line of the fuse-link.

V	$\varnothing A$	B	$\varnothing C_2$ <i>min.</i>	$\varnothing C_1$ and $C_2$ <i>max.</i>	$D$ <sup>0</sup> <sub>-1</sub>
7,2	45 ± 1	33 <sup>+2</sup> <sub>0</sub>	50	88	192
12					292
17,5					367
24					442
36					537

**Table 8 - Dimensions of fuses**

Dimensions in millimeters

The removal and replacement of fuses, as a result of their intervention, shall be allowed without using tools, insulating greases or similar products.

Guide discs or similar accessories independents of the fuse container shall not be acceptable. Any guide discs must be fixed to the fuse tube itself.

The kinematics of the fuse-carrier, where the striker acts for the opening of the switch-disconnector, shall be made so as to be operated independently from the striker's diameter and, in any case, up to a maximum of 20 mm and should be compatible with medium type strikers according to paragraph 4.14 of IEC 60282-1.

The fuse holder contacts must be spring-loaded silver plated or nickel plated.

The maximum rated current of the fuses shall be 100 A for 24 kV and 63 A for 36 kV.

### Trip coil

**Subject:** Global Infrastructure and Networks – GSM001 - MV RMU with switch-disconnector

**Application Areas**

Perimeter: *Global*

Staff Function: -

Service Function: -

Business Line: *Infrastructure & Networks*

The transformer protection unit must be equipped with a release coil. The coil must work with 230 Vac (other coil operation voltages may be required, depending on the country) and perform correctly between 85% and 110% of that voltage. The coil shall be put inside the operating device protective shell and can be connected from the outside feeder circuit in a terminal block located under the removable front panel, jointly at the switch-disconnector status micro-switch connection.

This terminal block must be properly identified, and its replacement must be possible without service interruption.

The coil circuit shall have an insulation level, towards the earthed metallic parts of the switchgear, of 10kV (1 minute) at short-duration power-frequency withstand voltage and 20kV to lightning impulse withstand voltage (1,2/50 $\mu$ s)

It must be possible to replace the coil with the switchgear in service.

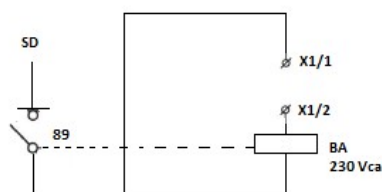

**Figure 20 – Electric diagram of coil connection**

The manufacturer must clearly indicate in the switchgear manual how the connection between outside feeder circuit and the trip coil must be made.

## Manometer

To verify an acceptable pressure level of SF6, a manometer shall be provided.

There must be one manometer for each independent SF6 gas-filled compartment that integrates the switchgear.

The manometer shall be non-extractable, and, in normal conditions, the pressure indication shall be between 25% and 75% of the area marked as safe. The area marked as safe shall be green RAL 6017 whereas the other area shall be red RAL 3000.



**Subject:** Global Infrastructure and Networks – GSM001 - MV RMU with switch-disconnector

**Application Areas**

Perimeter: *Global*

Staff Function: -

Service Function: -

Business Line: *Infrastructure & Networks*

The manometer will be mounted on the common area of the front panel and will be clearly visible under normal operating conditions.



**Figure 21 – Example of manometer**

## Earth connections

The earth of the switchgear shall be made with a copper wire whose section shall not be less than 50 mm<sup>2</sup>.

The operating shafts of the switch-disconnectors and of the earthing switches shall be connected to the earth (with conductors whose section shall not be less than 30 mm<sup>2</sup>) and to the other metallic objects. This connection is not necessary if the switchgear internal shaft is made of insulating material.

From the switchgear earthing point, a copper bar, whose section shall not be less than 50 mm<sup>2</sup>, shall be derived and it shall develop along the entire length of the switchgear. In correspondence of the line and transformer protection units it shall be provided a M12 bolt on which the earthing connections of the MV cable shields shall be fixed. This copper bar shall allow the connection to the secondary substation earth from both sides of the external part of the switchgear. For this reason, it shall be provided with two M12 bolts.

To remove the copper bar, it shall not be necessary to disassemble, totally or partially, the switchgear by inserting or removing a cable and its corresponding connector.

The earthing points on the outside of the switchgear must have an earthing symbol.



**Figure 22 - Earth connections**

## Installation

**Subject:** Global Infrastructure and Networks – GSM001 - MV RMU with switch-disconnector

**Application Areas**

Perimeter: *Global*

Staff Function: -

Service Function: -

Business Line: *Infrastructure & Networks*

The switchgear shall be fixed to the floor through M12 screws.

The switchgear must be able to be installed and operate correctly even with a floor unevenness up to 5 millimeters per meter, both longitudinally and transversely.



**Figure 23 - Floor fixing**

### Cable compartments

For each line unit and each transformer protection unit shall be included single-core steel supports or insulating supports suitable for the installation of MV cables in a vertical plane (with standardized plug-in connectors according to ENEL standard GSCC006). In case of metallic supports, induced currents shall be avoided.

In line units it must be possible to install symmetrical T connectors according to ENEL standard GSCC006 and in the transformer protection unit it must be possible to install elbow connectors according to ENEL standard GSCC006.

The installation height of the supports must be at least 450 mm from the connector.

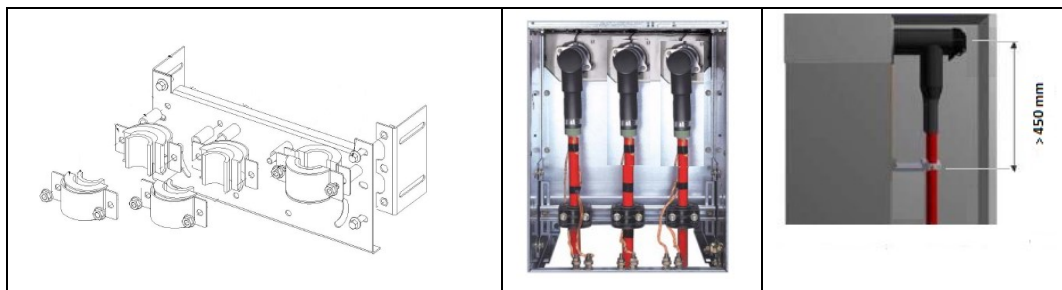

**Figure 24 – Example of connectors installation**

**Subject:** Global Infrastructure and Networks – GSM001 - MV RMU with switch-disconnector

**Application Areas**

Perimeter: *Global*

Staff Function: -

Service Function: -

Business Line: *Infrastructure & Networks*

For the design of cable support, it is necessary to consider the section of the cables used in the ENEL Companies from 50 mm<sup>2</sup> to 630 mm<sup>2</sup>.

The characteristics of the MV cables are according to ENEL Standard GSC001.

In addition to what is indicated in the previous point, for each unit, the cable compartment shall include:

- Steel panel to close the bottom of the compartment, with 3 holes in the bottom and adjustable cable gland for MV cables with a diameter from 28 to 65 mm (the panel will be used to prevent animals from entering the cable compartment). Abrasive or cutting contacts between the cable outer sheath and the edges of the steel panel holes shall be avoided.

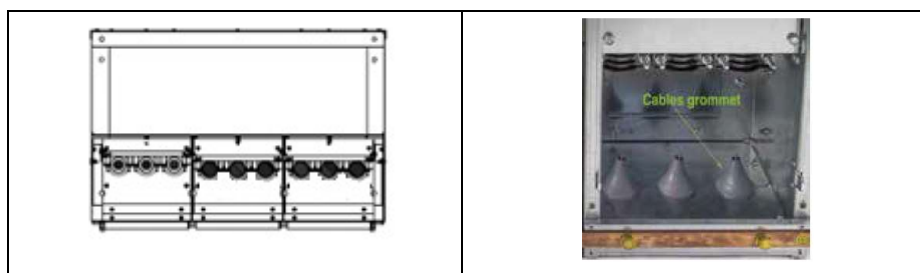

**Figure 25 – Installation of the steel plate**

For the supply to Spain, steel panels will not be installed in the cable compartment.

In correspondence with bushings, labels shall be applied to identify the three different phases according to the table 8 and figure 26.

Destination country	Marking of the phases
Colombia	L1 – L2 - L3
Chile	L1 – L2 - L3
Brazil	L1 – L2 - L3
Spain	L1 – L2 - L3
Peru	L1 – L2 - L3
Italy	L1 – L2 - L3
Romania	L1 – L2 - L3
Argentina	R – S - T

**Table 9 – Designation of the phases**

**Subject:** Global Infrastructure and Networks – GSM001 - MV RMU with switch-disconnector

**Application Areas**

Perimeter: *Global*

Staff Function: -

Service Function: -

Business Line: *Infrastructure & Networks*



**Figure 26 – Marking of the phases**

The access door to the cable compartment shall not be bolted.

### Voltage detecting systems

Each functional unit shall be equipped with a voltage detecting system (VDS) according to IEC 61243-5.

Depending on the destination country the VDS will be:

- Italy and Romania: separable MR system with portable voltage indicators.
- Spain, Colombia, Argentina, Brazil, Peru and Chile: integrated system with and available HR or LRM connecting points for the connection of a universal separable detector or a universal phase comparator (UPC)



**Figure 27 – VDS types**

On the VDS must be indicated the marking of the phases depending on the destination of the equipment as indicated in the table 9

Destination country	Marking of the phases
Colombia	L1 – L2 - L3
Chile	L1 – L2 - L3

**Subject:** Global Infrastructure and Networks – GSM001 - MV RMU with switch-disconnector

**Application Areas**

Perimeter: *Global*

Staff Function: -

Service Function: -

Business Line: *Infrastructure & Networks*

Brazil	L1 – L2 - L3
Spain	L1 – L2 - L3
Peru	L1 – L2 - L3
Italy	L1 – L2 - L3
Romania	L1 – L2 - L3
Argentina	R – S - T

**Table 10 – Designation of the phases on the VDS**

Except for Peru and Spain, an additional VDS must be installed on all compact RMU intended to check the voltage presence on the busbars.

The bushing of the capacitive divider for the voltage detection system should preferably be positioned on top of the busbars. The VDS must be installed on the transformer unit (if present). If the compact RMU does not include a transformer unit, the VDS shall be installed on the upper part of the front panel of the second line unit (from left).



**Figure 28 - Bushing of the capacitive divider and example of connection of the busbar voltage detector**

Each voltage detector system, clearly distinct for each unit, shall be surrounded by a box with the words "BUSBAR SIDE" or "CABLE SIDE". The busbar bushings must be covered to be protected against direct contacts.

Language	BUSBAR SIDE	CABLE SIDE
Italian	LATO SBARRE	LATO CAVI
Spanish	LADO BARRAS	LADO CABLES
Portuguese	LADO BARRA	LADO CABO
Romain	LATERAL BARE	LATERAL CABLU

**Table 11 – Designation of the VDS**

The following markings shall be legibly affixed to the interface, in characters at least 3 mm high:

**Technical Specification code: MAT-E&C-NC-2021-0052-EGIN**

Version no. 2 dated 08/07/2021

**Subject:** Global Infrastructure and Networks – GSM001 - MV RMU with switch-disconnector

**Application Areas**
Perimeter: *Global*

Staff Function: -

Service Function: -

Business Line: *Infrastructure & Networks*

- Capacitive interface symbol (fig. 4 of IEC 61243-5).
- Symbol of the detection system (MR, HR, LRM).
- On each interface: phase designation and earth symbol (fig. 5 of IEC 61243-5).

The VDS must be accompanied by documentation which include instructions for use, maintenance, storage, transport, assembly, voltage range for safe indication, function and in-service tests (according to Annex B of IEC 61243-5).

The supplier must present the certification according to IEC 61243-5 and the dossier with the type tests performed.

### Low Power voltage Transformers

Each phase of each line unit (CBL and L RMU) shall be equipped with LOW-POWER VOLTAGE TRANSFORMERS (LPVT) compliant with technical specifications GSCT005 "Technical characteristics of LPITs for RGDM / RGDAT", with the clarifications indicated below:

The connection cables (one per phase, for each line unit) and the related connectors, considered an integral part of the LPIT, shall comply with the GSCT005 specification and integrated into the equipment, exiting near the RGDAT/RGDM support, with sufficient length available (the cables shall exit the compartment for 30 cm).

The secondary terminations of the LPVT intended to be connected to the ground shall be connected to the compartment ground inside it.

### Support for the fault detector device and cable duct

In the upper part of each line unit a support shall be provided for the fault detector device (as shown in figure 29), located in its same vertical projection. These supports must be external and must allow the removal of the command protection shell without being removed.

Always in the upper part of the switchgear, a cable duct must be provided for the external wiring of the cables that connect the motor and the fault detector to the UP.

**Subject:** Global Infrastructure and Networks – GSM001 - MV RMU with switch-disconnector

**Application Areas**

Perimeter: *Global*

Staff Function: -

Service Function: -

Business Line: *Infrastructure & Networks*

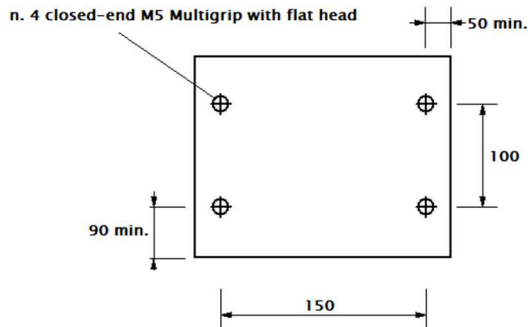

**Figure 29 -Support for the fault detector device and cable duct**

### Command lever

During the operations, the end of the command lever shall not stick out from the two sides of the switchgear.

The command lever must be made in steel, treated with electrolytic zinc-plating according to ISO 2081 (FZn 12 III) standard and must be stamped with the name of the manufacturer preferably with molding or, in any case, with a permanent indelible solution.

The manual operation of opening and closing of the operating devices must be carried out using only one command lever for all devices, without the need for additional tools.

### Switchgear dimensions

The maximum overall dimensions shall comply with table 11.

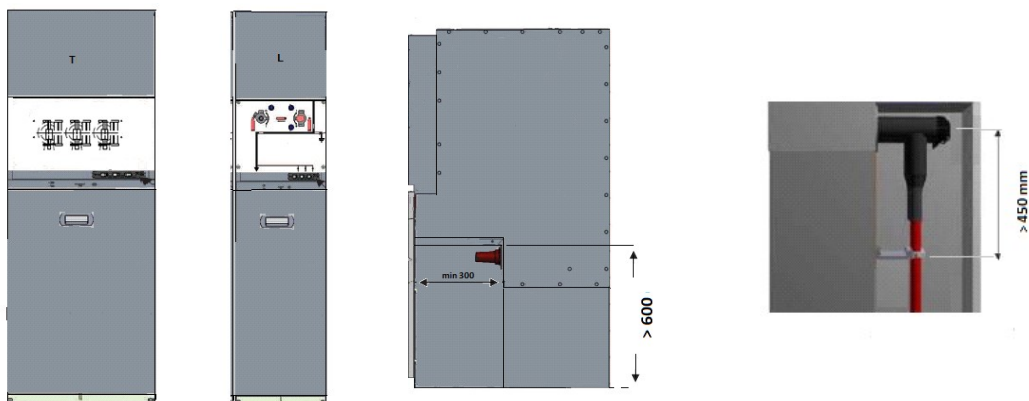

**Subject:** Global Infrastructure and Networks – GSM001 - MV RMU with switch-disconnector

**Application Areas**

Perimeter: *Global*

Staff Function: -

Service Function: -

Business Line: *Infrastructure & Networks*

Unit	Width Max (mm) 24 kV	Width Max (mm) 36 kV	Depth ** Max (mm) 24 kV	Depth** Max (mm) 36 kV	Height * Max (mm)
Transformer	520	600	900	1100	2000
Line	400	450	900	1100	2000

**Table 12 – Switchgear dimensions**

\* Including RGDAT support

\*\* Including the free space required between the switchgear and the rear wall

The height from the floor level to the lowest operation point shall be at least 1.0 m.

### Modular units

The modular units (1L and 1T) must be equipped with extension terminations on the flanks of the units, to allow extension on both sides.

The units will be connected each other via insulated connectors. IP3X degree of protection between assembled modular cells shall be ensured. All connection accessories will be part of the supply.

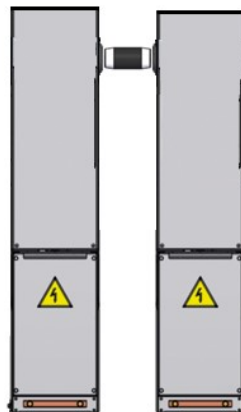

**Extensible modules**

### Protective coating

#### Basic protection

The metal carpentry must be painted with a paint conforming to series ISO 12944 and a for corrosivity class C3 and durability HIGH



**Technical Specification code: MAT-E&C-NC-2021-0052-EGIN**

Version no. 2 dated 08/07/2021

**Subject:** Global Infrastructure and Networks – GSM001 - MV RMU with switch-disconnector

**Application Areas**
Perimeter: *Global*

Staff Function: -

Service Function: -

Business Line: *Infrastructure & Networks*

	Edesur	ENEL Goias	ENEL Chile	ENEL Codensa	E-Distribuzione	ENEL Distributie	e-distribución
<b>Corrosivity class</b>	C3	C3	C3	C3	C3	C3	C3
<b>Durability</b>	HIGH	HIGH	HIGH	HIGH	HIGH	HIGH	HIGH

**Table 13 – Companies with basic protection protective coating**

No manual painting process is permitted.

To check the performance of the painting system, a test according to IEC 60068-2-52 with method 5 shall be performed. At the end of this test, routine tests shall be performed.

As an alternative it is possible to use pre-galvanized steel type EN10346 with coating thickness > 200 [g / m<sup>2</sup>] except for the cable compartment door and front panel.

The ferrous parts of the operating controls shall be protected by an electrolytic coating of 12 µm of zinc, or alternatively in stainless steel.

Mounting nuts and bolts and small accessories, unless otherwise specified, shall be protected with electrolyte zinc Fe III Zn EN ISO 4042.

## High protection

For high pollution environments the following characteristics must be respected:

- Degree of protection for the operating devices IP51 (see Table 4 for the standard requirement)
- The metal carpentry must be painted with a paint conforming to ISO 12944 and a for corrosivity class C5
- and durability HIGH

	ENEL Rio	ENEL Ceará	ENEL Sao Paulo	ENEL Peru
<b>Corrosivity class</b>	C5	C5	C5	C5
<b>Durability</b>	HIGH	HIGH	HIGH	HIGH
<b>Degree of protection</b>	IP51	IP51	IP51	IP51

**Table 14 – Companies with high protection protective coating**

To check the performance of the painting system, a test according to IEC 60068-2-52 with method 6 shall be performed. At the end of this test, routine tests shall be performed.

**Technical Specification code: MAT-E&C-NC-2021-0052-EGIN**

Version no. 2 dated 08/07/2021

**Subject:** Global Infrastructure and Networks – GSM001 - MV RMU with switch-disconnector**Application Areas**Perimeter: *Global*

Staff Function: -

Service Function: -

Business Line: *Infrastructure & Networks*

Alternative solutions/tests to demonstrate the equivalent suitability in this kind of environment can be proposed by the manufacturer and are subject to ENEL approval.

Equipment using alternative shall have the front part of the manual and electric control in green color (RAL code to be defined in agreement with Enel),

## Nameplates

### Rating plate and fluorinated gases plate

The switchgear shall be provided with a rating plate which shall contain the information according to Table 101 of IEC 62271-200, indicating the Enel country code applicable.

The plate must be made of anodized aluminium or adhesive printed with a laser printer and must be durable and clearly legible under service conditions.

In reference to the European regulation regarding fluorinated greenhouse gases, the switchgear will include nameplates that comply in number, content, position and characteristics with:

- Regulation (EU) No 517/2014 of the European Parliament and of the Council of 16 April 2014 on fluorinated greenhouse gases and repealing Regulation (EC) No 842/2006
- Commission Implementing Regulation (EU) 2015/2068 of 17 November 2015 establishing, pursuant to Regulation (EU) No 517/2014 of the European Parliament and of the Council, the format of labels for products and equipment containing fluorinated greenhouse gases.

### Operating sequence nameplates and synoptic scheme

The switchgears shall be equipped with an operating sequence nameplate on which the sequence of operations to be executed shall be reported, respectively (in local language): close line / transformer output (switch-disconnector closed), the sequence open line / transformer output (safe condition) and sequence to access to the fuses (if applicable).

In addition, a label with the operating sequence in the cable compartment, clearly visible with the access panel removed, indicating the sequence for setting the cable test (showing the sequence of the opening of the earthing switch with the cable compartment access door removed).

The synoptic scheme of each single functionality (transformer or line unit) must be displayed and shall be positioned in the front panel part of each unit, so that it is clearly visible under service condition.

**Subject:** Global Infrastructure and Networks – GSM001 - MV RMU with switch-disconnector

**Application Areas**

Perimeter: *Global*

Staff Function: -

Service Function: -

Business Line: *Infrastructure & Networks*

### Warning nameplate against switchgear drilling

Each switchgear shall have circular nameplates, visible from all accessible sides during service, indicating the prohibition to use a drill, or similar tool, to avoid the perforation of the gas-filled compartment.

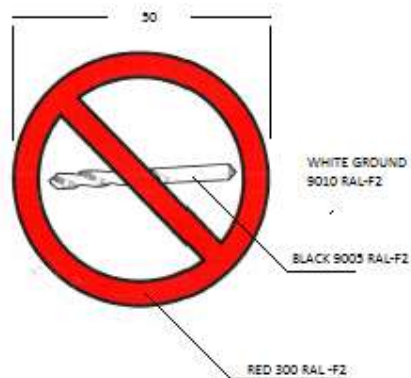

**Figure 30 – Warning plate against drilling**

### Label holder

Every functional unit shall have a label holder with a transparent window with dimensions of 120x50 mm.



**Figure 31 – Label holder**

### Warning plate

Every functional unit shall have a warning plate on the access door to the cable compartment, clearly visible in service condition, with the following characteristics:

**Subject:** Global Infrastructure and Networks – GSM001 - MV RMU with switch-disconnector

**Application Areas**

Perimeter: *Global*

Staff Function: -

Service Function: -

Business Line: *Infrastructure & Networks*

---

- Triangle background: yellow.
- Arrow and triangle outline: black.
- Plate: Adhesive or attached to the door with rivets in stainless steel, aluminum or 3 mm thick plastic.
- For Colombia, this sign shall comply with the terms of article 6 of RETIE (Signal and Symbology).



**Figure 32 – Warning plate**

## **Maintenance**

The switchgear shall be maintenance free for the entire expected service life.

## **Packaging, handling and impact indicators (Shockwatch)**

The switchgear enclosure shall have adequate strength, considering the stresses to which it is subject during transport. On the upper part of the switchgear, eye bolts shall be installed to allow movement by means of bridge crane, forklift or overhead crane.

**Subject:** Global Infrastructure and Networks – GSM001 - MV RMU with switch-disconnector

**Application Areas**

Perimeter: *Global*

Staff Function: -

Service Function: -

Business Line: *Infrastructure & Networks*

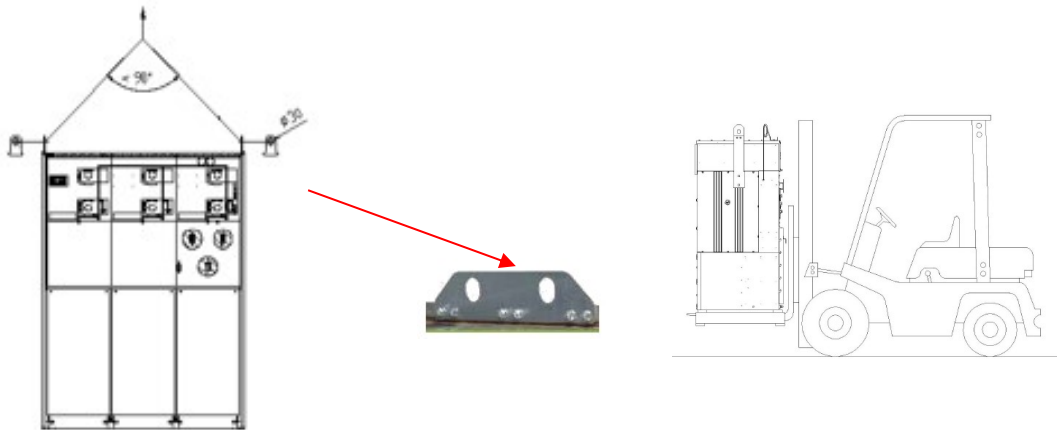

**Figure 33– Examples of handling**

The switchgear shall be packed with a recyclable material waterproof film wrapped around it, with protective panels to shield the command part.

Each switchgear shall be equipped with a shock indicator (ShockWatch).

Indicators consist of labels containing a red liquid in suspension. If the device is subjected to an impact higher than a specific G level declared by the manufacturer, the impact will cause the red liquid to escape, clearly visible. The label shall be on the front of the appliance and clearly visible.



**Figure 34 - ShockWatch**

## 7.6 TESTING

All tests described in the following paragraphs shall be performed on the switchgear:

**Technical Specification code: MAT-E&C-NC-2021-0052-EGIN**

Version no. 2 dated 08/07/2021

**Subject:** Global Infrastructure and Networks – GSM001 - MV RMU with switch-disconnector**Application Areas**Perimeter: *Global*

Staff Function: -

Service Function: -

Business Line: *Infrastructure & Networks*

---

Tests are divided in:

- Type tests and Special test (tests for TCA)
- Routine tests
- Acceptance tests

The tests described in the following paragraphs shall be carried out on the switchgear according to IEC 62271-102, IEC62271-103, IEC 62271-105 and IEC 62271-200.

Type and special tests will be performed on samples submitted to the TCA.

## Type tests

Table 14 shows the list of type tests to be carried out on the switchgear.

For the validation of the modular units, the type tests must be carried out, as minimum, on 2L+T assemblies, combined in such a way that all the following elements are tested:

- Line units.
- Transformer unit.
- The connection kits.
- A final insulating cap installed on a line unit.
- A final insulating cap installed on a transformer unit.

All switching devices that are part of each unit must have passed all type tests of their respective standards: IEC 62271-102 and IEC 62271-103 for switch-disconnectors and IEC 62271-102 for earthing switches.

**Technical Specification code: MAT-E&C-NC-2021-0052-EGIN**

Version no. 2 dated 08/07/2021

**Subject:** Global Infrastructure and Networks – GSM001 - MV RMU with switch-disconnector

**Application Areas**
Perimeter: *Global*

Staff Function: -

Service Function: -

Business Line: *Infrastructure & Networks*

TEST	STANDARD	CHAPTER
Visual inspection	GSM001	
Dielectric tests	IEC 62271-200	6.2
Partial discharge test (partial discharge shall not be more than 100 pC at 1,1 Ur).	IEC 62271-200	6.2.9
Measurement of the resistance of the main circuit and auxiliary circuits	IEC 62271-200	6.4
Temperature-rise tests	IEC 62271-200	6.5
Short-time withstand current and peak withstand current tests	IEC 62271-200	6.6
Verification of the protection (IP and IK)	IEC 62271-200	6.7
Tightness tests	IEC 62271-200	6.8
Electromagnetic compatibility tests (EMC)	IEC 62271-200	6.9
Additional test on auxiliary and control circuits	IEC 62271-200	6.10
Verification of making and breaking capacities	IEC 62271-200	6.101
Mechanical operation tests	IEC 62271-200	6.102
Pressure withstand test for gas-filled compartments	IEC 62271-200	6.103
Internal arc test	IEC 62271-200	6.106
Tests to verify the proper functioning of the position-indicating device	IEC 62271-102	7.105
Mechanical and environmental tests	IEC 62271-103	6.102
Mechanical operation tests (for switch-fuse combinations)	IEC 62271-105	6.102
Measurement of the resistance of the main circuit	IEC 62271-105	6.4
Temperature-rise tests	IEC 62271-105	6.5
Mechanical shock tests on fuses	IEC 62271-105	6.103
Thermal test with long pre-arcing time of fuse	IEC 62271-105	6.104
Check painting requirements (C3-HIGH or C5-HIGH)	ISO 12944-6	ISO 12944-6
Verification of the protective coating	ISO 2409	LEVEL 0 (applicable to all RMU codes)
Environmental testing	IEC 60068-2-52	METHOD 5 (only applicable for "basic protection" RMU)
Environmental testing	IEC 60068-2-52	METHOD 6 (only applicable for "high protection" RMU)
Seismic test	IEC TS 62271-210	Severity level 1 – PGA 0,5 g– CLASS 2

**Table 15 – List of type tests for the switchgear**
**Internal arc test**

For the internal arc test on cable compartment, no gas expansion to the cable trench is admitted.

**Technical Specification code: MAT-E&C-NC-2021-0052-EGIN**

Version no. 2 dated 08/07/2021

**Subject:** Global Infrastructure and Networks – GSM001 - MV RMU with switch-disconnector**Application Areas**Perimeter: *Global*

Staff Function: -

Service Function: -

Business Line: *Infrastructure & Networks*

---

**Temperature-rise tests for switch-fuse combinations**

The temperature-rise tests of the switch-fuse combination shall be carried out as follows:

For 24 kV switchgear:

- The test shall be carried out using a set of fuses with a rated current  $\geq 100$  A
- During the test, the power dissipation in the fuse-link will be  $\geq 90$  W
- The minimum current through the fuses shall be 50 A

For 36 kV switchgear:

- The test shall be carried out using a set of fuses with a rated current  $\geq 63$  A
- During the test, the power dissipation in the fuse-link will be  $\geq 90$  W.
- The minimum current through the fuses shall be 30 A

With these conditions, chapter 6.105.2 of IEC 62271-105 applies.

**Special Tests****Test to verify the effectiveness of the protection against pollution**

Referring to point 6.102 of IEC 62271-102, in the absence of a safe connection to earth, to verify the effectiveness of the protection against pollution in service of the insulating materials, it shall be performed the following test:

1) with the switch-disconnector isolated, it shall be applied a 60 kV power frequency voltage (for 24 kV RMU) or 80 kV power frequency voltage (for 36 kV RMU) between inlet and outlet, measuring the leakage current.

2) the switch-disconnector is then subject to the following cycle, that simulates a 10 years electrical service life to be repeated 3 times:

- 20 openings at 100 Arms and  $\cos\varphi = 0,7$
- 8 closings at 4 kArms and  $\cos\varphi = 0,15$
- 15 closings at 3 kArms and  $\cos\varphi = 0,15$
- 10 openings at 100 Arms and  $\cos\varphi = 0,7$



**Technical Specification code: MAT-E&C-NC-2021-0052-EGIN**

Version no. 2 dated 08/07/2021

**Subject:** Global Infrastructure and Networks – GSM001 - MV RMU with switch-disconnector

**Application Areas**
Perimeter: *Global*

Staff Function: -

Service Function: -

Business Line: *Infrastructure & Networks*

- 30 closings at 200 Arms and  $\cos\varphi = 0,7$
- 37 closings at 2 kArms and  $\cos\varphi = 0,15$
- 15 closings at 1 kArms and  $\cos\varphi = 0,15$
- 15 openings at 100 Arms and  $\cos\varphi = 0,7$

3) the switch-disconnector shall be subject to the tests of the previous point 1.

The test result is positive if there are no discharges on the switch-disconnector and if the leakage current value doesn't exceed 30 mA.

### Routine tests

Table 15 shows the list of routine tests to be carried out on the switchgear.

Routine tests must be carried out at the factory by the manufacturer on all equipment to ensure that the equipment conforms to the type-tested equipment.

TEST	STANDARD	CHAPTER
Dielectric test on the main circuit	IEC 62271-200	7.1
Tests on auxiliary and control circuits	IEC 62271-200	7.2
Measurement of the resistance of the main circuit	IEC 62271-200	7.3
Tightness tests	IEC 62271-200	7.4
Design and visual checks	IEC 62271-200	7.5
Partial discharge measurement	IEC 62271-200	7.101
Mechanical operation tests	IEC 62271-200	7.102
Pressure tests of gas-filled compartments	IEC 62271-200	7.103
Tests of auxiliary electrical, pneumatic and hydraulic devices	IEC 62271-200	7.104
Measurement of fluid condition after filling on site	IEC 62271-200	7.106

**Table 16 – List of routine tests for the switchgear**

### Acceptance tests

All the tests indicated in Table 17 shall be carried out by the supplier on all the samples prepared for the commissioning. For each piece that belongs to the prepared batch, the supplier shall prepare a test report with the results of the tests performed.

**Technical Specification code: MAT-E&C-NC-2021-0052-EGIN**

Version no. 2 dated 08/07/2021

**Subject:** Global Infrastructure and Networks – GSM001 - MV RMU with switch-disconnector

**Application Areas**
Perimeter: *Global*

Staff Function: -

Service Function: -

Business Line: *Infrastructure & Networks*

The acceptance tests shall be repeated by the supplier, under the Distribution Companies surveillance, on a sample chosen randomly among those ones of the batch that has already been successfully tested by the supplier. The tests shall be carried out on samples defined by the sampling plan below:

A	1 sample for type
B	At least 1 sample for type
D	Test to be certified on single units by the supplier
K	If the sample is constructed as a unique tank, these tests can be executed on the complete tank with the same sampling plan indicated for the modules

**Table 17 - Sampling plan**

**Technical Specification code: MAT-E&C-NC-2021-0052-EGIN**

Version no. 2 dated 08/07/2021

**Subject:** Global Infrastructure and Networks – GSM001 - MV RMU with switch-disconnector

**Application Areas**
Perimeter: *Global*

Staff Function: -

Service Function: -

Business Line: *Infrastructure & Networks*

Test	Standard	Sampling plan	
		Transf. Unit	Line Unit
Visual inspection (a)	GSM001		
Dielectric test on the main circuit (g) (K)	IEC 62271-200 – 7.1	B	B
Tests on auxiliary and control circuits (b)	IEC 62271-200 – 7.2	B	B
Measurement of the resistance of the main circuit (e) (K)	IEC 62271-200 – 7.3	B	B
Tightness test (D)	IEC 62271-200 – 7.4	D	D
Design and visual checks (a)	IEC 62271-200 – 7.5	A	A
Partial discharge measurement (i)	IEC 62271-200 -7.101	D	D
Mechanical operation tests (c) (K)	IEC 62271-200 -7.102	B	B
Tests of auxiliary electrical, pneumatic and hydraulic devices (K)	IEC 62271-200 – 7.104	B	B
Tests on voltage detecting system	IEC 62271-200 -7.105	B	B
Verification of proactive coating	ISO 2808	B	B
Dielectric test on the main circuit (g)	IEC 62271-102 § 7.1		
Mechanical operating tests (c)	IEC 62271-102 § 7.101	B	B
Verification of earthing function	IEC 62271-102 § 8.102	B	B
Dry-film thickness	ISO 2808	B	B
Verification of the protective coating	ISO 2409	LEVEL 0	LEVEL 0
Control of the degree of protection (IP51)	IEC 62271-200	Par. 6.7	Par. 6.7

**Table 18 - Testing plan**

**Technical Specification code: MAT-E&C-NC-2021-0052-EGIN**

Version no. 2 dated 08/07/2021

**Subject:** Global Infrastructure and Networks – GSM001 - MV RMU with switch-disconnector

**Application Areas**
Perimeter: *Global*

Staff Function: -

Service Function: -

Business Line: *Infrastructure & Networks*

a	Including the verification of the gas –filled compartment s' degree of protection (IP).
b	1 kV power frequency testing voltage (10 kV for trip coil) during 1 second.
c	perform 5 manual maneuvers of the SD (transformer) measuring the speed of the main contacts in opening and closing and 5 manual operations of the earthing switch Es (line) and of the earthing switches ES1 - ES2 (transformer) measuring the speed of the pristin contacts in closure. During the maneuvers verify all the mechanical interlocks provided.
d	5 closing and 5 opening operations at Vmin (24 Vcc-15%) and Vmax (24 Vcc + 20%). At Vn (24 Vcc) perform 5 C-O cycles and 5 Ot-C-O cycles. In the last cycle of every sequence, measure the operation times, the absorption current of the coils and of the spring charging motor. All the measured times and maximum values of absorption shall be included in the limits specified by the Manufacturer and, in any case, they shan't be outside the $\pm 15\%$ of the reference values obtained during the type tests.
e	Test to be performed on the same configuration used during the homologation process.
g	The test shall be performed with the operating devices closed and on the sectioning distance. All the tests shall be performed at a 50 kV power frequency voltage (for 24 kV switch-disconnector) or 70 kV power frequency voltage (for 36 kV switch-disconnector).
h	Perform the thickness verification with sampling plan "B" and the adherence verification on one sample only.
i	Test to be certified on single units by the supplier

**Table 19 - Additional information**

## 7.7 SUPPLY REQUIREMENTS

Each switchgear shall be supplied with:

- The modular units must be supplied with connection kits and insulating end caps.
- One command lever;
- For Spain, the "Declaración de Conformidad" certificate requested by RD337/2014;
- Installation and operation manual in the language of the Country in which the switchgear has to be delivered, in compliance of the IEC 62271 series standards (including indication about SF6 end-of-life management and methods of recovery of gas SF6, see chapter 13 of IEC 62271-1);
- A connection cable for each line unit equipped with connectors for connection between the switchgear and the UP peripheral unit;
- A connection cable to connect the transformer unit with the UP;
- For Argentina: The switchgear must be supplied with connectors for the connection of underground dry insulation cables (XLPE) with a section ranging from 185/50 to 500/50 mm<sup>2</sup>. The technical characteristics of the connectors will be defined at tender stage.

Outside the box containing the equipment, the following indications shall be reported with clearly legible characters:

- name of the Distribution Company;

**Technical Specification code: MAT-E&C-NC-2021-0052-EGIN**

Version no. 2 dated 08/07/2021

**Subject:** Global Infrastructure and Networks – GSM001 - MV RMU with switch-disconnector**Application Areas**Perimeter: *Global*

Staff Function: -

Service Function: -

Business Line: *Infrastructure & Networks*

---

- name of the supplier;
- description of the product;
- code assigned by the supplier;
- type code and local code of the Distribution Company;
- gross weight.

In case of switchgear delivered to Colombia, the manufacturer shall include the mandatory RETIE certificate in the TCA dossier.

In case of switchgear delivered to Spain, the manufacturer shall include in the TCA dossier the mandatory certificate prescribed (Declaración de Conformidad) at ITC-RAT 03 in R.D. 337/2014.

**Technical Specification code: MAT-E&C-NC-2021-0052-EGIN**

Version no. 2 dated 08/07/2021

**Subject:** Global Infrastructure and Networks – GSM001 - MV RMU with switch-disconnector

**Application Areas**
Perimeter: *Global*

Staff Function: -

Service Function: -

Business Line: *Infrastructure & Networks*

## 8. ANNEX A - INTERLOCKS CHECKING

In order to verify the correct functioning of the interlocks, it is necessary to check their operation according to the tables below:

Status	Switch-disconnector	Earthing switches	Allowed	Forbidden	Impossible	Possible access to fuse and cable compartment
0	OPEN	OPEN	0,1,2		3	NO
1	OPEN	CLOSED	0,1	3	2	YES
2	CLOSED	OPEN	0,2	3	1	NO
3	CLOSED	CLOSED				

### Transformer unit interlock

Status	Switch-disconnector	Earthing switch	Allowed	Forbidden (Both manual operation and motorized operation)	Impossible	Possible access to fuse and cable compartment
0	OPEN	OPEN	0,1,2		3	NO
1	OPEN	CLOSED	0,1	3	2	YES
2	CLOSED	OPEN	0,2	3	1	NO
3	CLOSED	CLOSED				

### Line unit Interlock

 Non reachable status

With the cable or fuse access panel removed (Transformer unit):

- A mechanical interlock prevents the manual operation of the switch disconnector.
- An electrical interlock prevents the motorized operation of the switch disconnector (both by pushbutton and remotely).
- A mechanical interlock prevents the operation of the earthing switch.

While the access door to the cable compartment is removed (Line unit):

- The earthing switch can be opened after the insertion of screwdriver, but only one time.

**Technical Specification code: MAT-E&C-NC-2021-0052-EGIN**

Version no. 2 dated 08/07/2021

**Subject:** Global Infrastructure and Networks – GSM001 - MV RMU with switch-disconnector**Application Areas**Perimeter: *Global*

Staff Function: -

Service Function: -

Business Line: *Infrastructure & Networks*

---

- The interlock for open the earthing switch returns when the screwdriver is removed. The earthing switch can be closed, but it can't be opened newly without the intervention of the screwdriver.
- The switch-disconnector remains locked in any case, regardless the position of the earthing switch.
- The access door can't be replaced if the earthing switch is open.

The insertion of the command lever in both operation points (switch-disconnector and earthing switch) prevents the motorized operation of the switch-disconnector.



**Subject:** Global Infrastructure and Networks – GSM001 - MV RMU with switch-disconnector

**Application Areas**

Perimeter: *Global*

Staff Function: -

Service Function: -

Business Line: *Infrastructure & Networks*

## 9. ANNEX B - CHARACTERISTICS OF THE ELECTRICAL COMMAND

### Electric motor

The switch-disconnector will be operated by an electric motor, suitable for continuous service, having the following characteristics:

Supply voltage	[V <sub>cc</sub> ]	24 +20% -15%
Power consumption at full speed	[W]	≤ 300
Degree of protection		≥ IP3X

**Table 20 - Characteristics of the electric motor**

### Electric command of the switch-disconnector

The electrical control of the switch-disconnector must implement an operating cycle by means of a motor of the dead point exceeding type with the following functional characteristics:

- the stability of the position of the switch-disconnector contacts must be ensured until the dead center has been exceeded;
- if, during any operation, a power failure occurs before the dead center is exceeded, the system must allow the kinematic mechanism to be reset so that the command lever can be inserted;
- the motorization circuit must not absorb any current when it is in the stand-by state;

The input impedance of the command circuit must be in the range of 5-5000 Ω.

### Connections

The energy for the motorized control is supplied by power supply housed in the peripheral unit for remote control of the secondary substations (UP).

The supply circuits for the motors ( $\pm M$ ) and for the auxiliaries ( $\pm A$ ) shall remain separate and isolated from each other and are protected by different bipolar protections in the power supply.

For the wiring between the motorized control and the power supply (line unit) a multipolar cable shall be provided with characteristics indicated in table 20, equipped at the ends with the flying parts of the connectors described in figure 35.



**Technical Specification code: MAT-E&C-NC-2021-0052-EGIN**

Version no. 2 dated 08/07/2021

**Subject:** Global Infrastructure and Networks – GSM001 - MV RMU with switch-disconnector

**Application Areas**
Perimeter: *Global*

Staff Function: -

Service Function: -

Business Line: *Infrastructure & Networks*

To show the open position of the switch-disconnector in the transformer unit, a 2x1.5 mm<sup>2</sup> LV cable with a length of 8 m with characteristics indicated in table 20 shall be provided.

Rated insulation voltage	[V]	300/500
Conductors for each cable in line unit (11x1,5 mm)	n	11
Conductors for each cable in transformer unit (2x1,5 mm)	n	2
Length	[m]	8 ± 0,20
Outer diameter (on insulation) of cores	[mm]	≤ 3
Flexible string conductors of annealed non-tinned copper		
PVC insulation of quality R2		
Distinction of cores by marked numbers (according to EN 50334)		
RZ quality PVC sheath (according to EN 50395)		
Fire non-propagation characteristics (according to EN 50575)		

**Table 21 - Characteristics of the external cable**

### Internal wiring

For internal wiring shall be used wire sections suitable for the correct operation of the equipment.

The end of each connection shall be equipped with pre-insulated terminals suitable for the type of connection required (faston, cylindrical, eyelet, etc.), identification marks, as well as reference to the wiring diagram.

Each cable passage hole shall be equipped with a suitable cable gland.

### Connectors

To interface the electrical control circuit with the external remote unit, it is necessary to provide the fixed part of a circular connector, onto which the detachable connector of the type shall be inserted. (See figure 36)

The coupling of the parts shall be ensured by means of a quick-release screw ring nut.

The detachable part of the rectangular connector provided at the other end of the cable shall be of the type shown in figure 37.

**Subject:** Global Infrastructure and Networks – GSM001 - MV RMU with switch-disconnector

**Application Areas**

Perimeter: *Global*

Staff Function: -

Service Function: -

Business Line: *Infrastructure & Networks*

Both the fixed and the detachable parts shall be made of insulating material with dielectric characteristics.

The fixed part of the connector shall be accompanied by a cap (anti loss type); the detachable ones shall have cable clamps.

The position of the connector must be positioned on the corresponding of the line unit and once the detachable part is connected the associated cable must not interfere with any of the switching or signaling elements of the control equipment.

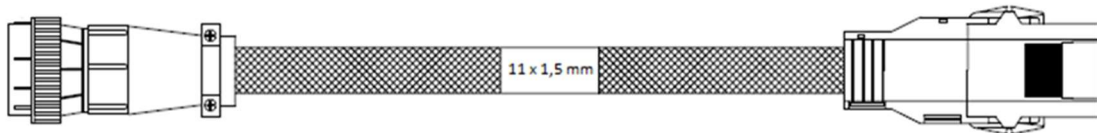

**Figure 35 - Connection cable between the motorization and the Peripheral Unit for the line units**

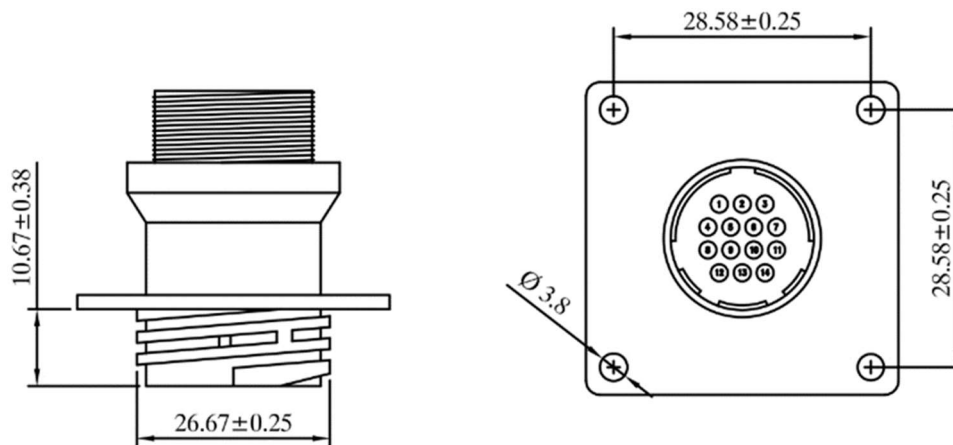

**FIXED PART**



**Technical Specification code: MAT-E&C-NC-2021-0052-EGIN**

Version no. 2 dated 08/07/2021

**Subject:** Global Infrastructure and Networks – GSM001 - MV RMU with switch-disconnector

**Application Areas**

Perimeter: *Global*

Staff Function: -

Service Function: -

Business Line: *Infrastructure & Networks*

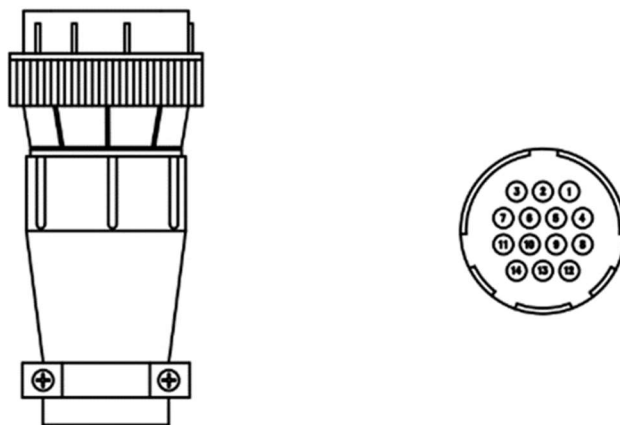

**DETACHABLE PART**

**Figure 36 - Connectors at RMU side**

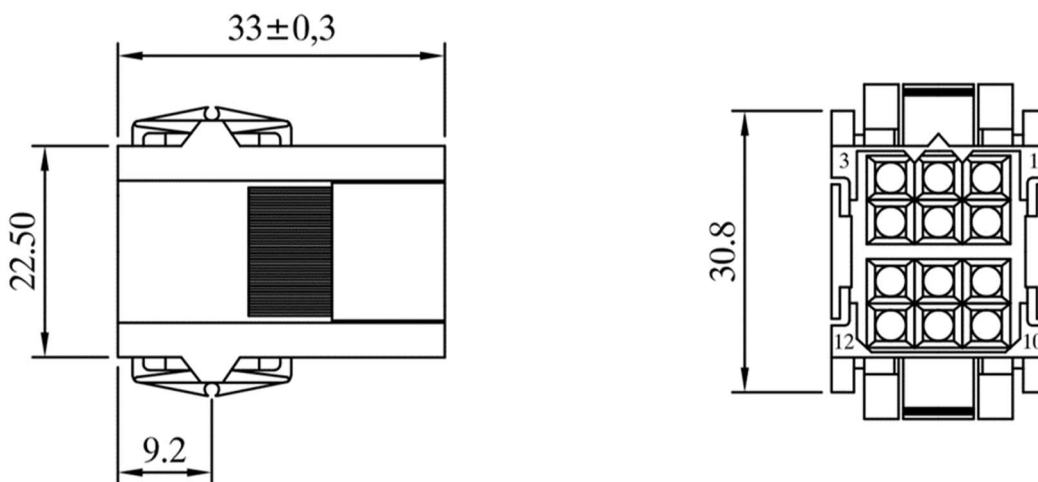

**Figure 37 - Connector on the Peripheral Unit side of the cable**

The wiring diagram of the cables should be as follows:



**Technical Specification code: MAT-E&C-NC-2021-0052-EGIN**

Version no. 2 dated 08/07/2021

**Subject:** Global Infrastructure and Networks – GSM001 - MV RMU with switch-disconnector

**Application Areas**

Perimeter: *Global*

Staff Function: -

Service Function: -

Business Line: *Infrastructure & Networks*

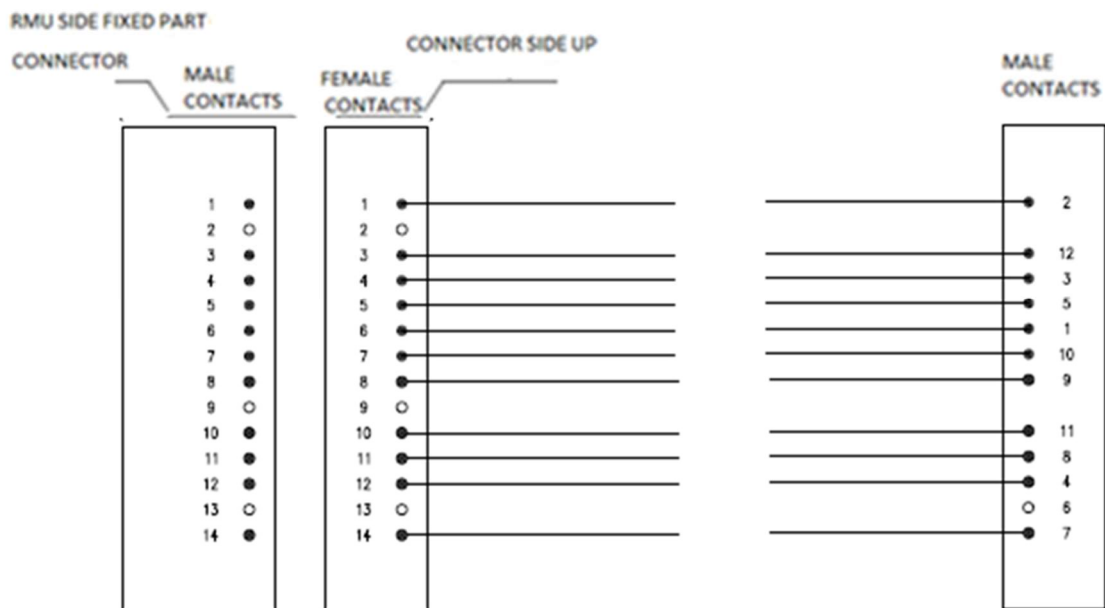
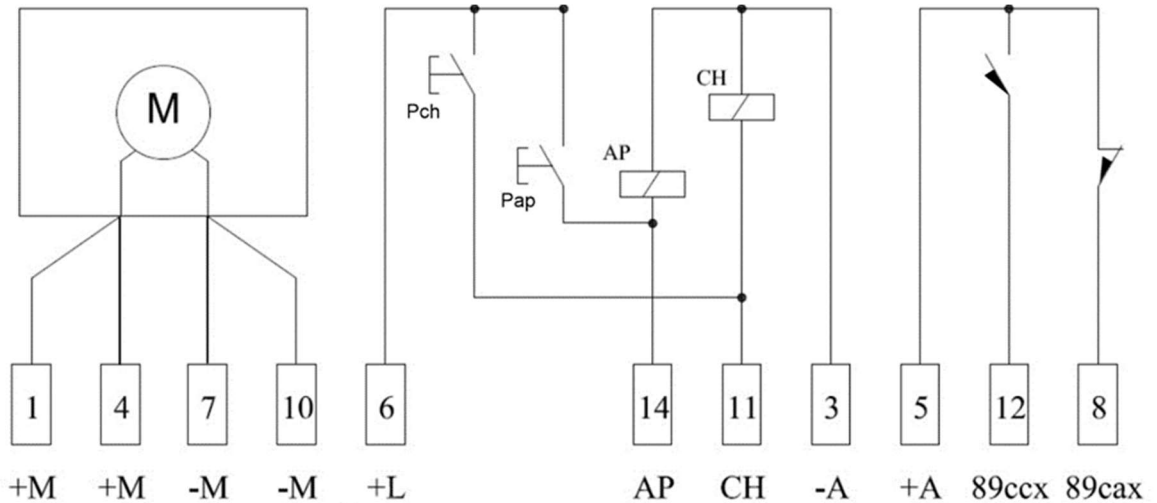

**Figure 38- Electric scheme of the switch-disconnector command**

1	+M	Motor supply voltage (+24 Vcc)	8	89cax	Signal opening position switch-disconnector
---	----	--------------------------------	---	-------	---

**Technical Specification code: MAT-E&C-NC-2021-0052-EGIN**

Version no. 2 dated 08/07/2021

**Subject:** Global Infrastructure and Networks – GSM001 - MV RMU with switch-disconnector

**Application Areas**
Perimeter: *Global*

Staff Function: -

Service Function: -

Business Line: *Infrastructure & Networks*

2		Not used	9		Not used
3	- A	Common (-24 Vcc) commands	10	- M	Motor supply voltage (-24 Vcc)
4	+ M	Motor supply voltage (+24 Vcc)	11	CH	Closing command
5	Com TS	Common position signals switch-disconnector	12	89ccx	Signal closing position switch-disconnector
6	+ L	Local commands supply (+24 Vcc)	13		Not used
7	- M	Power supply (-24 VDC) motor	14	AP	Opening command

**Table 22 - Pin connector motorisation side**

1	+ L	Local commands supply (+24 Vcc)	7	AP	Opening command
2	+ M	Motor supply voltage (+24 Vcc)	8	CH	Closing command
3	+ M	Motor supply voltage (+24 Vcc)	9	89cax	Signal opening position switch-disconnector
4	89ccx	Signal closing position switch-disconnector	10	- M	Power supply (-24 VDC) motor
5	Com TS	Common position signals switch-disconnector	11	- M	Power supply (-24 VDC) motor
6		Not used	12	- A	Common (-24 Vcc) commands

**Table 23 - Connector Peripheral Unit side**









**Technical Specification code: MAT-E&C-NC-2021-0052-EGIN**

Version no. 2 dated 08/07/2021

**Subject:** Global Infrastructure and Networks – GSM001 - MV RMU  
with switch-disconnector

## Application Areas

TYPE CODE	EDESUR ARGENTINA	ENEL DISTRIBUCÃO RIO	ENEL DISTRIBUCÃO CEARÁ	ENEL DISTRIBUCÃO GOIÁS	ENEL DISTRIBUCÃO SÃO PAULO	ENEL DISTRIBUCION CHILE	ENEL DISTRIBUCION COLOMBIA	E-DISTRIBUZIONE ITALIA	ENEL DISTRIBUCION PERU'	E- DISTRIBUTIE BANATA DOBROGEA MUNTENIA	EDESTRIBUCION R.D. SLU
GSM001/39											140293
GSM001/40		T140041									140477
GSM001/41											140268
GSM001/42											140519
GSM001/43											140517
GSM001/44											140259
GSM001/45		T140038									140263
GSM001/46								140001			

## Protection C5M-H

Type Code	DESCRIPTION	ENEL DISTRIBUCÃO RIO	ENEL DISTRIBUCÃO GOIÁS	ENEL DISTRIBUCÃO CEARÁ	ENEL DISTRIBUCION PERU
		C5M-H	C5M-H	C5M- H	C5M- H
GSM001/6	MV RMU 2L+1T 24kV - 16kA PROTECTION C5M-H				140175
GSM001/10	MV RMU 1LE 24kV - 16kA PROTECTION C5M-H	T140062			
GSM001/16	MV RMU 1T 24kV - 16kA PROTECTION C5M-H	T140064			

**Technical Specification code: MAT-E&C-NC-2021-0052-EGIN**

Version no. 2 dated 08/07/2021

**Subject:** Global Infrastructure and Networks – GSM001 - MV RMU  
with switch-disconnector

**Application Areas**

Perimeter: Global	GSM001/21	MV RMU 1LE 24kV - 20kA PROTECTION C5M-H	T140063	
Staff Function: -	GSM001/26	MV RMU 1T 24kV - 20kA PROTECTION C5M-H	T140065	
Service Function: -				

Business Line: *Infrastructure & Networks*
**Enel codes alternative gas**

TYPE CODE	TYPE CODE	EDESUR ARGENTINA	ENEL DISTRIBUÇÃO RIO	ENEL DISTRIBUÇÃO CEARÁ	ENEL DISTRIBUÇÃO GOIÁS	ENEL DISTRIBUÇÃO SÃO PAULO	ENEL DISTRIBUCION CHILE	ENEL DISTRIBUCION COLOMBIA	E-DISTRIBUZIONE ITALIA	ENEL DISTRIBUCION PERU'	E- DISTRIBUTIE BANATA DOBROGEA MUNTENIA	EDESTIBUCION R.D. SLU
GSM001/47	GSM001 ALTERNATIVE INSULATION GAS 3L, 24 KV, 20 KA, 630A											160070
GSM001/48	GSM001 ALTERNATIVE INSULATION GAS 2L + T, 24 KV, 20 KA, 630A											160071
GSM001/49	GSM001 ALTERNATIVE INSULATION GAS 2L + T, 24 KV, 16KA, 630A								140117			

**Technical Specification code: MAT-E&C-NC-2021-0052-EGIN**

Version no. 2 dated 08/07/2021

**Subject:** Global Infrastructure and Networks – GSM001 - MV RMU with switch-disconnector**Application Areas**Perimeter: *Global*

Staff Function: -

Service Function: -

Business Line: *Infrastructure & Networks*

---

**11. ANNEX D - FORM FOR SPECIFIC DEVIATIONS**

This form is used for evaluating the offer in the tender process and also for the technical data validation during the homologation, certification and approval procedure.

Flag here the use of this form:

 Offer in the Tender Technical Data Validation

This document has to be used for checking the compliance of the switch-disconnector during the tender process.

Deviations are in principle not acceptable.

Possible deviations have to be clearly reported in the following form for specific deviations.

The acceptance of this document for the next tender stage does not mean the acceptance of any deviation to the technical specification if such deviations are not clearly reported in the form for specific deviations.



**Technical Specification code: MAT-E&C-NC-2021-0052-EGIN**

Version no. 2 dated 08/07/2021

**Subject:** Global Infrastructure and Networks – GSM001 - MV RMU with switch-disconnector

**Application Areas**

Perimeter: *Global*

Staff Function: -

Service Function: -

Business Line: *Infrastructure & Networks*

**FORM FOR SPECIFIC DEVIATIONS**

Each specific deviation shall be reported and explained here below (to be indicated with a progressive number).

NO DEVIATIONS

(to flag in case of no deviations from the Global Standard)

**DEVIATION 1**

[To indicate possible Deviation

.....  
.....  
.....  
.....]

**DEVIATION 2**

[To indicate possible Deviation

.....  
.....  
.....  
.....]

**DEVIATION ...**

[To indicate possible Deviation

.....  
.....  
.....  
.....]

Date [.....]

Sign [.....]



**Subject:** Global Infrastructure and Networks – GSM001 - MV RMU with switch-disconnector

**Application Areas**
Perimeter: *Global*

Staff Function: -

Service Function: -

Business Line: *Infrastructure & Networks*
**12. ANNEX E - CHECK-LIST**

SWITCH-DISCONNECTORS – LINE UNIT				
Rated Voltage	[kV]	24	36	
Rated normal current	[A]	630		
Rated short-time withstand current	[kA]	16/20		
Rated peak withstand current	[kA]	40 (and 41,6) / 50 (and 52)		
Rated duration of short-circuit	[s]	1		
Mechanical endurance class		M1		
Electrical endurance class		E3		
Rated breaking current	of a mainly active load	[A]	630	
	of a no-load line	[A]	1,5	2
	of a no-load cable	[A]	16	20
	in case of earth fault	[A]	60	
	with cable-charging in case of earth fault	[A]	40	
EARTHING SWITCH				
Rated Voltage	[kV]	24	36	
Rated short-time withstand current	[kA]	16/20		
Crest value of the rated short-time withstand current	[kA]	40 (and 41,6) / 50 (and 52)		
Rated short-circuit duration	[s]	1		
Mechanical endurance class		M0		
Electrical endurance class		E2		
TRANSFORMER UNIT				
SWITCH-DISCONNECTOR				
Rated voltage	[kV]	24	36	
Rated normal current	[A]	200		
Rated short-time withstand current	[kA]	16/20		
Rated peak withstand current	[kA]	40 (and 41,6) / 50 (and 52)		
Rated duration of short-circuit	[s]	1		
Mechanical endurance class		M1		
Electrical endurance class		E3		
EARTHING SWITCHES ES1 (SOLUTION A, C), ES (IN CASE OF CONSTRUCTIVE SOLUTION B)				
Rated short-time withstand current	[kA]	16/20		
Crest value of the rated short-time withstand current	[kA]	40 (and 41,6) / 50 (and 52)		
Rated short-circuit duration	[s]	1		
Mechanical endurance class		M0		
Electrical endurance class		E2		
EARTHING SWITCH ES2 (SOLUTION A)				
Rated short-time withstand current	[kA]	1		
Crest value of the rated short-time withstand current	[kA]	2,5		
Rated short-circuit duration	[s]	1		
Mechanical endurance class		M0		
Electrical endurance class		E2		